

Guide for the Development of Bicycle Facilities

2012 • Fourth Edition



AMERICAN ASSOCIATION OF
STATE HIGHWAY AND
TRANSPORTATION OFFICIALS

AASHTO
THE VOICE OF TRANSPORTATION

Guide for the Development of Bicycle Facilities

2012 • Fourth Edition



American Association of State Highway and Transportation Officials

444 North Capitol Street, NW, Suite 249

Washington, DC 20001

202-624-5800 phone 202-624-5806 fax

www.transportation.org

© 2012 by the American Association of State Highway and Transportation Officials. All rights reserved.
Duplication is a violation of applicable law.

Front cover photographs courtesy of Alaska DOT, Carole Reichardt (Iowa DOT), and the Alliance for Biking and Walking. Back cover photograph courtesy of Patricia Little.

Publication Code: GBF-4 • ISBN: 978-1-56051-527-2

Executive Committee 2011–2012

Officers

President: Kirk Steudle, P.E., MICHIGAN
Vice President: Michael P. Lewis, RHODE ISLAND
Secretary/Treasurer: Carlos Braceras, UTAH

Regional Representatives

REGION I
Beverley K. Swaim-Staley, MARYLAND
James P. Redeker, CONNECTICUT

REGION II
Robert St. Onge, SOUTH CAROLINA
Eugene Conti, NORTH CAROLINA

REGION III
Kevin Keith, MISSOURI
Mark Gottlieb, WISCONSIN

REGION IV
Francis G. Ziegler P.E., NORTH DAKOTA
John Cox, WYOMING

Non-Voting Members

Executive Director: John Horsley, AASHTO
Immediate Past President: Susan Martinovich, P.E., NEVADA

Technical Committee on Geometric Design

Officers

Jeff Jones, Tennessee, Chair
James Rosenow, Minnesota, Vice Chair
Brooke Struve, FHWA, Secretary

Members

Kent Belleque	OREGON
James O. Brewer	KANSAS
Rick Bruce	OHIO
Marshall Elizer	AMERICAN PUBLIC WORKS ASSOCIATION
Mark A. Leiferman	SOUTH DAKOTA
Donald A. Lyford	NEW HAMPSHIRE
Deanna Maifield	IOWA
Eric Marabello	MARYLAND
Reza Maleki	PORT AUTHORITY OF NEW YORK AND NEW JERSEY
Joe Ruffer	NATIONAL ASSOCIATION OF COUNTY ENGINEERS
Brent Story	GEORGIA
Bart Thrasher	VIRGINIA
Max Valerio	NEW MEXICO
Ted Watson	NEBRASKA
Stanley Wood	MASSACHUSETTS
Reza Amini	OKLAHOMA
Ray Derr	TRANSPORTATION RESEARCH BOARD
Robert Wunderlich	NATIONAL LEAGUE OF CITIES

Highway Subcommittee On Design

Barry Schoch, Pennsylvania, Chair
Richard Land, California, Vice Chair
David A. Nichol, FHWA, Secretary
Keith M. Platte, AASHTO, Staff Liaison

ALABAMA	William Adams, Rex Bush, Carey Kelley
ALASKA	Mark Neidhold, Robert A. Campbell
ARIZONA	VACANT
ARKANSAS	Michael Fugett, Phillip L. McConnell
CALIFORNIA	Terry L. Abbott, Kevin Hanley
COLORADO	Jeffrey Wassenaar
CONNECTICUT	James H. Norman, Timothy M. Wilson, Will Britnell
DELAWARE	Thad McIlvain, Mark Tudor
DISTRICT OF COLUMBIA	Muhammad Khalid, Dawit Muluneh
FLORIDA	David O'Hagan, Frank Sullivan
GEORGIA	Russell McMurry, Brent Story, G. Andy Casey
HAWAII	Julius Fronza
IDAHO	Loren D. Thomas, Monica Crider
ILLINOIS	Scott E. Stitt
INDIANA	Jeff Clanton, Merrill E. Dougherty, John E. Wright
IOWA	Michael J. Kennerly, David L. Little, Deanna Maifield
KANSAS	James O. Brewer, Rod Lacy
KENTUCKY	Keith Caudill, Bradley S. Eldridge, Jeff D. Jasper
LOUISIANA	Nicholas Kalivoda, III, Chad Winchester
MAINE	Bradford P. Foley, Heath Cowan
MARYLAND	Kirk G. McClelland
MASSACHUSETTS	Stanley Wood, Jr.
MICHIGAN	Bradley C. Wiefelich
MINNESOTA	John M. Chiglo, Mike Ginnaty
MISSISSIPPI	John M. Reese, Amy Mood, Richard Pittman
MISSOURI	David B. Nichols, Kathryn P. Harvey
MONTANA	Paul R. Ferry, Lesly Tribelhorn

NEBRASKA	James J. Knott, Ted Watson
NEVADA	Paul Frost, Kristena Shigenaga
NEW HAMPSHIRE	William Oldenburg
NEW JERSEY	Richard Jaffe, Richard Dunne
NEW MEXICO	Gabriela Contreras-Apodaca
NEW YORK	Daniel D'Angelo, Richard Lee
NORTH CAROLINA	Deborah M. Barbour, Jay A. Bennett, Art McMillan
NORTH DAKOTA	Roger Weigel
OHIO	Dirk Gross, James Young
OKLAHOMA	Tim Tegeler
OREGON	David Joe Polly, Steven R. Lindland
PENNSYLVANIA	Wayne Willey
PUERTO RICO	Luis Santos, José E. Santana-Pimentel
RHODE ISLAND	Robert Smith
SOUTH CAROLINA	Rob Bedenbaugh, Mark Lester, Mitchell D. Metts
SOUTH DAKOTA	Mark A. Leiferman
TENNESSEE	Jeff C. Jones, Carolyn Stonecipher
TEXAS	Mark A. Marek
UTAH	Lisa Wilson, Fred Doerhing, George Lukes
VERMONT	Kevin Marshia, Jesse Devlin
VIRGINIA	Robert H. Cary, Mohammad Mirshahi, Barton A. Thrasher
WASHINGTON	Pasco Bakotich, Terry L. Berends, Nancy Boyd
WEST VIRGINIA	Jason C. Foster, Dee Begley
WISCONSIN	Jerry H. Zogg
WYOMING	Tony Laird, Sandra Pecenka, Andrea Allen

ASSOCIATE MEMBER—Bridge, Port, and Toll

NJ TUR NPIKE AUTHORITY	J. Lawrence Williams
PORT AUTHORITY OF NY AND NJ	Scott D. Murrell

ASSOCIATE MEMBER—Federal

USDA FOREST SERVICE	Ellen G. LaFayette
---------------------	--------------------

ASSOCIATE MEMBER—International

ALBERTA	Moh Lali
BRITISH COLUMBIA	Richard Voyer
KOREA	Chan-Su “Chris” Reem
ONTARIO	Joe Bucik
SASKATCHEWAN	Sukhy Kent

Table of Contents

Chapter 1: Introduction	1-1
1.1 Design Imperative	1-1
1.2 Purpose.....	1-1
1.3 Scope.....	1-2
1.4 Definitions	1-2
Chapter 2: Bicycle Planning	2-1
2.1 Background	2-1
2.2 Why Planning for Bicycling is Important	2-1
2.3 Factors Influencing Bicycling Behavior	2-2
2.3.1 Trip Purpose	2-2
2.3.2 Level of User Skill and Comfort	2-4
2.4 Types of Transportation Planning Processes	2-6
2.4.1 Comprehensive Transportation Plans.....	2-6
2.4.2 Bicycle Master Plans	2-6
2.4.3 Transportation Impact/Traffic Studies.....	2-11
2.4.4 Small-Area and Corridor-Level Planning	2-12
2.4.5 Project Level Planning—Approvals.....	2-12
2.5 Planning Bicycle Transportation Networks	2-12
2.5.1 Deciding Where Improvements Are Needed.....	2-12
2.5.2 Practical (Opportunistic) Approach to Network Planning	2-14
2.5.3 Wayfinding for Bicycles	2-20
2.6 Technical Analysis Tools That Support Bicycle Planning	2-21
2.6.1 Data Collection and Flow Analysis	2-21
2.6.2 Quality of Service (or Level of Service) Tools	2-22
2.6.3 Safety Analysis	2-23
2.6.4 GIS-Based Data Collection/Network Planning.....	2-24
2.6.5 Bicycle Travel Demand Analysis.....	2-25
2.6.6 Cost-Benefit Analysis.....	2-26
2.6.7 Key Role of Public Input in the Process	2-26
2.7 Integrating Bicycle Facilities with Transit	2-27

Chapter 3: Bicycle Operation and Safety	3-1
3.1 Introduction	3-1
3.2 Design Vehicle	3-1
3.3 Traffic Principles for Bicyclists	3-4
3.4 Causes of Bicycle Crashes	3-6
3.4.1 Bicyclist Crash Studies	3-8
3.4.2 Overall Findings	3-8
3.4.3 Contributing Causes of Bicyclist-Motor Vehicle Crashes and Recommended Countermeasures	3-9
 Chapter 4: Design of On-Road Facilities	 4-1
4.1 Introduction	4-1
4.2 Elements of Design	4-1
4.3 Shared Lanes	4-2
4.3.1 Shared Lanes on Major Roadways (Wide Curb/Outside Lanes)	4-3
4.3.2 Signs for Shared Roadways	4-3
4.4 Marked Shared Lanes	4-4
4.5 Paved Shoulders	4-7
4.5.1 Shoulder Bypass Lanes	4-8
4.5.2 Rumble Strips	4-9
4.6 Bicycle Lanes	4-11
4.6.1 General Considerations	4-11
4.6.2 Bicycle Lanes on Two-Way Streets	4-12
4.6.3 Bicycle Lanes on One-Way Streets	4-12
4.6.4 Bicycle Lane Widths	4-14
4.6.5 Bicycle Lanes and On-Street Parking	4-16
4.7 Bicycle Lane Markings and Signs	4-17
4.7.1 Bicycle Lane Lines	4-17
4.7.2 Bicycle Lane Markings	4-18
4.7.3 Bicycle Lane Signs	4-21
4.8 Bicycle Lanes at Intersections	4-22
4.8.1 Right Turn Considerations	4-23
4.8.2 Left Turn Considerations	4-26
4.9 Retrofitting Bicycle Facilities on Existing Streets and Highways	4-28
4.9.1 Retrofitting Bicycle Facilities By Widening the Roadway	4-28
4.9.2 Retrofitting Bicycle Facilities Without Roadway Widening	4-29
4.10 Bicycle Boulevards	4-33
4.11 Bicycle Guide Signs/Wayfinding	4-34
4.12 Other Roadway Design Considerations	4-38

4.12.1	Railroad Grade Crossings	4-38
4.12.2	Obstruction Markings	4-40
4.12.3	Bridges, Viaducts, and Tunnels	4-41
4.12.4	Traffic Signals	4-43
4.12.5	Detection for Bicycles at Traffic Signals.....	4-47
4.12.6	Bicycles and Traffic Calming	4-51
4.12.7	Bicycles and Traffic Management	4-53
4.12.8	Drainage Grates and Utility Covers	4-55
4.12.9	Bicycle Travel on Freeways.....	4-56
4.12.10	Bicycle Travel Through Interchange Areas.....	4-57
4.12.11	Bicycle Travel at Roundabouts	4-63

Chapter 5: Design of Shared Use Paths 5-1

5.1	Introduction	5-1
5.1.1	Accessibility Requirements for Shared Use Paths.....	5-2
5.2	Elements of Design.....	5-2
5.2.1	Width and Clearance.....	5-3
5.2.2	Shared Use Paths Adjacent to Roadways (Sidepaths).....	5-8
5.2.3	Shared Use with Mopeds, Motorcycles, Snowmobiles, and Horses	5-11
5.2.4	Design Speed.....	5-12
5.2.5	Horizontal Alignment.....	5-13
5.2.6	Cross Slope.....	5-15
5.2.7	Grade	5-16
5.2.8	Stopping Sight Distance	5-17
5.2.9	Surface Structure	5-25
5.2.10	Bridges and Underpasses.....	5-26
5.2.11	Drainage.....	5-28
5.2.12	Lighting.....	5-29
5.3	Shared Use Path Roadway–Intersection Design	5-30
5.3.1	Shared Use Path Crossing Types	5-30
5.3.2	Design of Mid-Block Crossings	5-31
5.3.3	Examples of Mid-Block Intersection Controls	5-38
5.3.4	Sidepath Intersection Design Considerations.....	5-42
5.3.5	Other Intersection Treatments	5-45
5.3.6	Additional Bicycle Crossing Considerations.....	5-49
5.4	Pavement Markings, Signs, and Signals.....	5-50
5.4.1	Pavement Markings	5-50
5.4.2	Signs.....	5-52
5.4.3	Signalized and Active Warning Crossings.....	5-54

Chapter 6: Bicycle Parking Facilities	6-1
6.1 Introduction	6-1
6.2 Planning for Bicycle Parking.....	6-1
6.3 Short-Term Bicycle Parking Facilities.....	6-2
6.3.1 Site Design	6-3
6.3.2 Rack Design	6-3
6.3.3 Considerations for Special Types of Racks.....	6-4
6.4 Long-Term Bicycle Parking Facilities	6-4
Chapter 7: Maintenance and Operations	7-1
7.1 Introduction	7-1
7.2 Recommended Maintenance Programs and Activities	7-1
7.2.1 Sweeping	7-2
7.2.2 Surface Repairs	7-2
7.2.3 Pavement Overlays	7-3
7.2.4 Vegetation	7-3
7.2.5 Traffic Signal Detectors.....	7-4
7.2.6 Signs and Markings	7-4
7.2.7 Drainage Improvements	7-4
7.2.8 Chip Sealing.....	7-5
7.2.9 Patching Activities	7-5
7.2.10 Utility Cuts	7-5
7.2.11 Snow Clearance	7-6
7.3 Operating Bikeways in Work Zones.....	7-6
7.3.1 Rural Highway Construction.....	7-7
7.3.2 Urban Roadway Construction	7-7
Index	I-1

List of Figures

Chapter 2

Figure 2-1	Typical Wayfinding Signs.....	2-20
------------	-------------------------------	------

Chapter 3

Figure 3-1	Bicyclist Operating Space.....	3-2
Figure 3-2	Typical Bicycle Dimensions.....	3-3
Figure 3-3	Common Maneuvers for Bicyclists Turning Left at an Intersection	3-7

Chapter 4

Figure 4-1	“Share The Road” Sign Assembly	4-3
Figure 4-2	Bicycles “May Use Full Lane” Sign.....	4-3
Figure 4-3	“Wrong Way—Ride With Traffic” Sign Assembly	4-4
Figure 4-4	Shared-Lane Marking	4-5
Figure 4-5	Typical Shared-Lane Marking Cross Section on Street with Parking.....	4-6
Figure 4-6	Typical Shared-Lane Marking Cross Section on Street with No On-Street Parking.....	4-6
Figure 4-7	Shoulder Bypass Lane	4-8
Figure 4-8	Rumble Strips	4-9
Figure 4-9	Rumble Strip Design Parameters.....	4-10
Figure 4-10	Example of Paved Shoulder Designated as Bicycle Lane	4-11
Figure 4-11	Shared-Lane Marking and Bike Lane on Steep Street	4-12
Figure 4-12	Typical Markings for One-Way Street Designed for Two-Way Bicycle Travel	4-13
Figure 4-13	Typical Bike Lane Cross Sections	4-15
Figure 4-14	Example of Bike Lane Adjacent to Parallel Parking	4-16
Figure 4-15	Example of Bike Lane Adjacent to Back-in Diagonal Parking.....	4-17
Figure 4-16	Typical Bike Lane Pavement Markings.....	4-19
Figure 4-17	Bike Lane Symbol Markings	4-20
Figure 4-18	Example of Symbol Placement to Avoid Premature Wear.....	4-21
Figure 4-19	Bike Lane Sign.....	4-22
Figure 4-20	Examples of Bike Lanes Approaching Right-Turn-Only Lanes (With and Without Parking).....	4-24

Figure 4-21	Example of Bike Lane with Through Lane Transitioning to Right-Turn-Only Lane.....	4-25
Figure 4-22	Example of Bike Left-Turn-Only Lane.....	4-27
Figure 4-23	Example of Road Diet.....	4-31
Figure 4-24	Road Diet—Before and After.....	4-32
Figure 4-25	D11 Series Bicycle Route Signs.....	4-34
Figure 4-26	Wayfinding Signs.....	4-35
Figure 4-27	Typical Bicycle Guide Signage Layout.....	4-37
Figure 4-28	Correction for Skewed Railroad Grade Crossing—Separate Pathway	4-39
Figure 4-29	Correction for Skewed Railroad Grade Crossing—Widened Shoulder ..	4-40
Figure 4-30	Obstruction Marking.....	4-41
Figure 4-31	Diagonal Quadrupole Loop Detector	4-48
Figure 4-32	Conventional Quadrupole Loop Detector	4-48
Figure 4-33	Typical Bicycle Detector Pavement Marking	4-49
Figure 4-34	Bicycle Detector Pavement Marking and Sign	4-49
Figure 4-35	Examples of Bicycle-Friendly Approach Profiles for Speed Humps and Speed Tables.....	4-51
Figure 4-36	Curb Extensions	4-53
Figure 4-37	Choker with Bicycle Access.....	4-55
Figure 4-38	Bicycle-Compatible Drainage Grates.....	4-56
Figure 4-39	Example of Bike Lane on the Crossroad at a Freeway Interchange.....	4-58
Figure 4-40	Single-Point Diamond Interchange (SPDI).....	4-59
Figure 4-41	Option 1—Bike Lane and Free-Flow Merging Roadway.....	4-61
Figure 4-42	Option 2—Bike Lane and Free-Flow Merging Roadway	4-61
Figure 4-43	Example of Bike Lane and Diverging Roadway on an Arterial Street....	4-62
Figure 4-44	Typical Layout of Roundabout with Bike Lanes (4)	4-64

Chapter 5

Figure 5-1	Typical Cross Section of Two-Way Shared Use Path on Independent Right-of-Way	5-4
Figure 5-2	Minimum Width Needed to Facilitate Passing on a Shared Use Path	5-4
Figure 5-3	Safety Rail Between Path and Adjacent Slope.....	5-7
Figure 5-4	Sidepath Conflicts.....	5-10
Figure 5-5	Shared Use Path with Separate Unpaved Equestrian/Jogger Path.....	5-12
Figure 5-6	Minimum Stopping Sight Distance vs. Grades for Various Design Speeds—Ascending Climbing Grade.....	5-18
Figure 5-7	Minimum Stopping Sight Distance vs. Grades for Various Design Speeds—Descending Climbing Grade	5-19

Figure 5-8	Minimum Length of Crest Vertical Curve Based on Stopping Sight Distance.....	5-21
Figure 5-9	Diagram Illustrating Components for Determining Horizontal Sight Distance.....	5-23
Figure 5-10	Minimum Lateral Clearance (Horizontal Sightline Offset or HSO) for Horizontal Curves	5-24
Figure 5-11	Bridge Railing.....	5-27
Figure 5-12	Example of Bridge Structures	5-28
Figure 5-13	Mid-block and Sidepath Crossings Relative to Intersection Functional Area	5-31
Figure 5-14	Crossing Angle.....	5-32
Figure 5-15	Yield Sight Triangles.....	5-35
Figure 5-16	Minimum Path-Walkway Sight Triangle.....	5-37
Figure 5-17	Example of Mid-block Path–Roadway Intersection—Path is Yield Controlled for Bicyclists.....	5-39
Figure 5-18	Example Midblock Path–Roadway Intersection—Roadway is Yield Controlled	5-40
Figure 5-19	Example of Mid-block Path–Roadway Intersection—Path is Stop Controlled for Bicyclists.....	5-19
Figure 5-20	Example Mid-block Path–Roadway Intersection—Roadway is Stop Controlled	5-42
Figure 5-21	Bollard Approach Markings	5-47
Figure 5-22	Crossing Island	5-48
Figure 5-23	Advance Yield Signs and Markings.....	5-52
Figure 5-24	Advance Warning Assembly Example.....	5-53
Figure 5-25	Mode-Specific Guide Signs	5-54

Chapter 6

Figure 6-1	Directional Signage for Bicycle Storage	6-2
Figure 6-2	Example of “Inverted U” Bicycle Rack.....	6-3

List of Tables

Chapter 2

Table 2-1	Recreational Trips vs. Utilitarian Trips.....	2-4
Table 2-2	Casual/Less Confident vs. Experienced/Confident Riders.....	2-5
Table 2-3	General Considerations for Different Bikeway Types.....	2-17

Chapter 3

Table 3-1	Key Dimensions.....	3-3
Table 3-2	Key Performance Criteria.....	3-4

Chapter 4

Table 4-1	Formula for Determining Taper Length for Obstruction Markings.....	4-41
Table 4-2	Standing Bicycle Crossing Time.....	4-44
Table 4-3	Bicycle Minimum Green Time Using Standing Bicycle Crossing Time.....	4-45
Table 4-4	Rolling Bicycle Crossing Time Considering Braking Distance.....	4-46
Table 4-5	All-Red and Extension Time Using Rolling Bicycle Crossing Time.....	4-47

Chapter 5

Table 5-1	Minimum Radius of Curvature Based on Lean Angle.....	5-14
Table 5-2	Minimum Radii for Horizontal Curves on Paved, Shared Use Paths at 20-Degree Lean Angle.....	5-14
Table 5-3	Minimum Radius of Curvature Based on Superelevation.....	5-15
Table 5-4	Minimum Stopping Sight Distance.....	5-17
Table 5-5	Length of Crest Vertical Curve to Provide Sight Distance.....	5-20
Table 5-6	Horizontal Sight Distance.....	5-23
Table 5-7	Length of Roadway Leg of Sight Triangle.....	5-35
Table 5-8	Length of Path Leg of Sight Triangle.....	5-36
Table 5-9	Taper Length.....	5-49

1

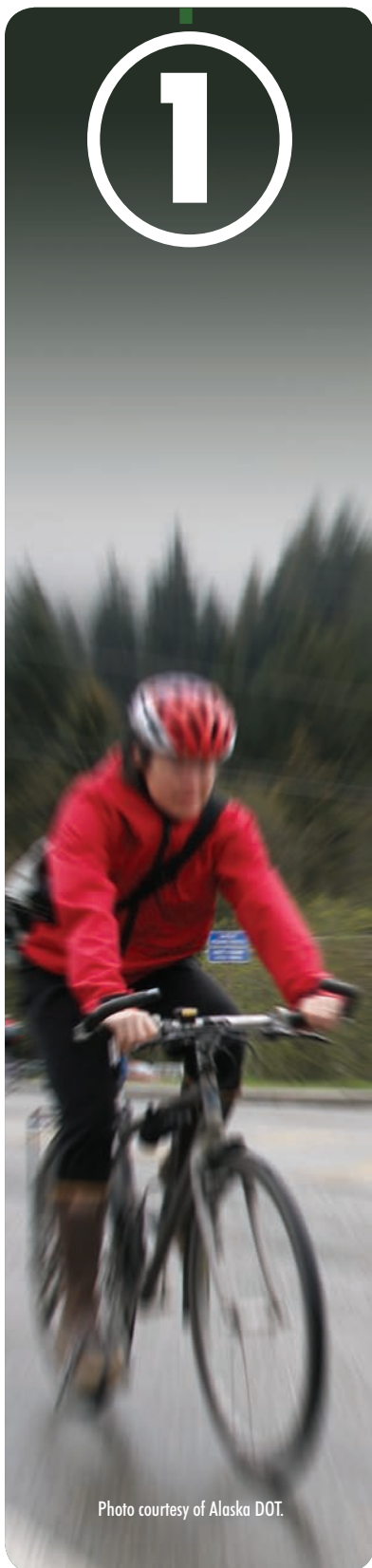

Photo courtesy of Alaska DOT.

Introduction

1.1 DESIGN IMPERATIVE

Bicycle travel has played a historic role in transportation. Even before the invention of the automobile, the League of American Wheelmen promoted improved traveled ways.

Bicycling is recognized by transportation officials throughout the United States as an important transportation mode. A policy statement, released in early 2010 by the U.S. Department of Transportation, emphasizes the needs and requirements to integrate bicycling (and walking) into transportation systems (4). Over a quarter of the population in the United States, over the age of 16 rides bicycles (3). Nationwide, people are recognizing the convenience, energy efficiency, cost effectiveness, health benefits, economic development, and environmental advantages of bicycling.

Local, state, and federal agencies are responding to the increased use of bicycles by implementing a wide variety of bicycle-related projects and programs. This interest in bicycle transportation calls for an understanding of bicycles, bicyclists, and bicycle facilities. This guide addresses these issues and clarifies the elements needed to make bicycling a more safe, comfortable, and convenient mode of transportation.

All roads, streets, and highways, except those where bicyclists are legally prohibited, should be designed and constructed under the assumption that they will be used by bicyclists. Therefore, bicyclists' needs should be addressed in all phases of transportation planning, design, construction, maintenance, and operations (1). All modes of transportation, including bicycles, should be jointly integrated into plans and projects at an early stage so that they function together effectively.

1.2 PURPOSE

Bicyclists should be expected on roadways, except where prohibited, and on shared use paths. Safe, convenient, well-designed, well-maintained facilities, with low-crash frequencies and severities, are important to accommodate and encourage bicycling.

This guide provides information on how to accommodate bicycle travel and operations in most riding environments. It is intended to present sound guidelines that result in facilities that meet the needs of bicyclists and other highway users. Sufficient flexibility is permitted to encourage designs that are sensitive to local context and incorporate the needs of bicyclists, pedestrians, and motorists. However, in some sections of this guide, suggested minimum dimensions are provided. These are recommended only where further deviation from desirable values could increase crash frequency or severity.

This guide has been updated from the previous guide published in 1999. The fact that new guidance is presented herein does not imply that existing bicycle facilities are inadequate or unsafe, nor does it mandate the initiation of improvement projects. The intent of this document is to provide guidance to designers and planners by referencing a recommended range of design values and describing alternative design approaches. Good design practice involves engineering cost-effective solutions that balance safety and mobility for all transportation modes, along with preservation of scenic, aesthetic, historic, cultural, and environmental resources. This guide is therefore not intended to be a detailed design or traffic engineering manual that could supersede the need for application of sound principles by the knowledgeable design or traffic engineering professional.

1.3 SCOPE

This guide provides information on the physical infrastructure needed to support bicycling. Facilities are only one of several elements essential to a community's overall bicycle program. Bicycle safety education and training, encouraging bicycle use, and enforcing the rules of the road as they pertain to bicyclists and motorists should be combined with engineering measures to form a comprehensive approach to bicycle use. Information on other elements of an overall bicycle program can be obtained from state or local bicycle coordinators and other publications.

The provisions for bicycle travel are consistent with, and similar to, normal highway engineering practices. Signs, signals, and pavement markings for bicycle facilities are presented in the *Manual on Uniform Traffic Control Devices* (MUTCD) (2), which should be used in conjunction with this guide. If there is a discrepancy between the content of this guide and the current edition of the MUTCD, then the MUTCD supersedes this guide for that case. For construction of bicycle facilities, applicable state and local construction specifications should be used.

1.4 DEFINITIONS

Bicycle—A pedal-powered vehicle upon which the human operator sits. The term “bicycle” for this publication includes three- and four-wheeled human-powered vehicles, but not tricycles for children. In some states, a bicycle is considered a vehicle, while in other states it is not.

Bicycle Boulevard—A street segment, or series of contiguous street segments, that has been modified to accommodate through bicycle traffic and minimize through motor traffic.

Bicycles Facilities—A general term denoting improvements and provisions to accommodate or encourage bicycling, including parking and storage facilities, and shared roadways not specifically defined for bicycle use.

Bicycle Lane or Bike Lane—A portion of roadway that has been designated for preferential or exclusive use by bicyclists by pavement markings and, if used, signs. It is intended for one-way travel, usually in the same direction as the adjacent traffic lane, unless designed as a contra-flow lane.

Bicycle Level of Service (BLOS)—A model used to estimate bicyclists' average perception of the quality of service of a section of roadway between two intersections.

Bicycle Locker or Bike Locker—A secure, lockable container used for individual bicycle storage.

Bicycle Network—A system of bikeways designated by the jurisdiction having authority. This system may include bike lanes, bicycle routes, shared use paths, and other identifiable bicycle facilities.

Bicycle Rack or Bike Rack—A stationary fixture to which a bicycle can be securely attached.

Bicycle Route or Bike Route—A roadway or bikeway designated by the jurisdiction having authority, either with a unique route designation or with Bike Route signs, along which bicycle guide signs may provide directional and distance information. Signs that provide directional, distance, and destination information for bicyclists do not necessarily establish a bicycle route.

Bicycle Wheel Channel—A channel installed along the side of a stairway to facilitate walking a bicycle up or down the stairs.

Bikeway—A generic term for any road, street, path, or way which in some manner is specifically designated for bicycle travel, regardless of whether such facilities are designated for the exclusive use of bicycles or are to be shared with other transportation modes.

Highway—A general term denoting a public way for purposes of vehicular travel, including the entire area within the right-of-way.

Independent Right-of-Way—A general term denoting right-of-way outside the boundaries of a conventional highway.

Rail-Trail—A shared use path, either paved or unpaved, built within the right-of-way of a former railroad.

Rail-with-Trail—A shared use path, either paved or unpaved, built within the right-of-way of an active railroad.

Right-of-Way—A general term denoting land, property or interest therein, usually in a strip, acquired for or devoted to transportation purposes.

Right of Way (Assignment)—The right of one driver or pedestrian to proceed in a lawful manner in preference to another driver or pedestrian.

Roadway—The portion of the highway, including shoulders, intended for vehicular use.

Recumbent Bicycle—A bicycle with pedals at roughly the same level as the seat where the operator is seated in a reclined position with their back supported.

Roundabout—A type of circular intersection that provides yield control to all entering vehicles and features channelized approaches and geometry to encourage reduced travel speeds through the circular roadway.

Rumble Strips—A textured or grooved pavement treatment designed to create noise and vibration to alert motorists of a need to change their path or speed. Longitudinal rumble strips are sometimes used on or along shoulders or center lines of highways to alert motorists who stray from the appropriate traveled way. Transverse rumble strips are placed on the roadway surface in the travel lane, perpendicular to the direction of travel.

Shared Lane—A lane of a traveled way that is open to both bicycle and motor vehicle travel.

Shared-Lane Marking—A pavement marking symbol that indicates an appropriate bicycle positioning in a shared lane.

Shared Roadway—A roadway that is open to both bicycle and motor vehicle travel.

Shared Use Path—A bikeway physically separated from motor vehicle traffic by an open space or barrier and either within the highway right-of-way or within an independent right-of-way. Shared use paths may also be used by pedestrians, skaters, wheelchair users, joggers, and other non-motorized users. Most shared use paths are designed for two-way travel.

Shoulder—The portion of the roadway contiguous with the traveled way that accommodates stopped vehicles, emergency use, and lateral support of subbase, base, and surface courses. Shoulders, where paved, are often used by bicyclists.

Sidewalk—That portion of a street or highway right-of-way, beyond the curb or edge of roadway pavement, which is intended for use by pedestrians.

Sidepath—A shared use path located immediately adjacent and parallel to a roadway.

Traveled Way—The portion of the roadway intended for the movement of vehicles, exclusive of shoulders and any bike lane immediately inside of the shoulder.

Unpaved Path—Path not surfaced with a hard, durable surface such as asphalt or Portland cement concrete.

REFERENCES

1. AASHTO. *A Policy on Geometric Design of Highways and Streets*. American Association of State Highway and Transportation Officials, Washington, DC, 2011.
2. FHWA. *Manual on Uniform Traffic Control Devices*. Federal Highway Administration, U.S. Department of Transportation, Washington, DC, 2009.
3. National Highway Traffic Safety Administration, Bureau of Transportation Statistics. *National Survey of Pedestrian and Bicyclist Attitudes and Behaviors*. U.S. Department of Transportation, Washington, DC, 2002.
4. U.S. Department of Transportation. *Policy Statement on Bicycle and Pedestrian Accommodation Regulations and Recommendations*. Washington, DC, March 2010.
<http://www.dot.gov/affairs/2010/bicycle-ped.html>



Bicycle Planning

2.1 BACKGROUND

Bicycling is a healthy, low cost mode of travel that is available to nearly everyone. Bicycling is also one of the most energy-efficient forms of transportation available. Since bicycling emits no pollution, needs no external energy source, and uses land efficiently, it effectively moves people from one place to another without adverse environmental impacts. For communities working to address a wide range of issues from traffic congestion to climate change, bicycling is a transportation solution that works at both local and global levels.

Surveys show that people support bicycling because it makes neighborhoods safer and friendlier, saves on transportation costs, provides a way to routinely get physical activity, and reduces transportation-related environmental impacts, emissions, and noise. Bicycling increases the flexibility of the transportation system by providing additional mobility options, especially for short-distance trips that are considered too long to walk. Bicycle transportation is particularly effective in combination with transit systems, as when used together, each expands the range of the other mode.

2.2 WHY PLANNING FOR BICYCLING IS IMPORTANT

As communities throughout the United States face new challenges, bicycling provides a solution to many different concerns. Since the bicycle is an appropriate vehicle for many trips, it can play a significant role in sustainable land-use planning, transportation, recreation, and economic development initiatives. Particularly in urban and suburban centers, where a large percentage of trips are shorter than two miles in length, bicycling can serve as part of a comprehensive approach to alleviate traffic congestion and provide flexible, convenient, and affordable travel options. Bicycling is also very compatible with transit system development, and can effectively expand the area served by each transit stop.

Like other users of the transportation system, bicyclists need access to jobs, goods and services, recreational activities, and other destinations. Planning for existing and potential bicycle use should

be integrated into and coordinated with the overall transportation planning process. Transportation improvements can provide an opportunity to enhance the safety and convenience of bicycle travel.

Improvements made for bicyclists often result in better conditions for other transportation users. For instance, paved shoulders, wide curb lanes, and bike lanes not only provide improved conditions for bicyclists, but also increase motorist comfort. However, these can increase crossing distances for pedestrians. Between intersections, bike lanes and paved shoulders result in more consistent separation between bicyclists and passing motorists. Bike lanes improve sight distance for motorists at driveways and provide a buffer area between sidewalks and traffic lanes, making streets more comfortable for pedestrians. Communities that have improved conditions for bicycling have seen positive results for all users.

Plans for implementing bicycle projects often need supportive policies in a community's general plan, master transportation plan, zoning ordinances, and subdivision regulations. These may need to be amended to support bicycle-compatible roadway design, encourage shared use path connections between neighborhoods, require bicycle parking, and create land-use policies that keep destinations closer to home and work.

Providing for bicycling touches on many different aspects of community planning, and a good bicycle plan reflects this dynamic. Depending on the community, a bicycle plan may involve many diverse aspects, such as signal timing and progression, safety education, building codes and parking facility design, land-use policies, school busing policies, social marketing to promote flexible transportation options, roadway maintenance and transit access, and many others.

2.3 FACTORS INFLUENCING BICYCLING BEHAVIOR

Many characteristics have been used to classify different types of bicycle riders. Among the most common are comfort level, physical ability, and trip purpose. These characteristics can be used to help develop generalized profiles of various bicycle user types. People will not fit into a single category, and a rider's profile may change in a single day; for example, as a commuter switches to a parent who takes a child for a recreational ride. Still, these profiles provide a way to gauge approximate level of comfort on and preference for specific facility types.

2.3.1 Trip Purpose

Utilitarian/Nondiscretionary

Utilitarian or nondiscretionary trips are trips that are needed as part of a person's daily activities. These commonly include commute trips to work or school, work-related non-commute trips, shopping and errands, or taking a child to school. Depending on the length of trip and quality of bicycling conditions on transportation facilities, among other factors, bicycling trips can replace or seamlessly link with other transportation modes such as transit or motor vehicle trips.

While some people may choose to bicycle for transportation, others may use bicycles for utilitarian trips because they do not have access to an automobile or possess a driver's license, have no transit available, or are otherwise dependent upon bicycling.

School trips are a special type of utilitarian trip that involve younger riders and call for careful attention to their characteristics. School children can and do use the transportation system to bicycle to and from school. There is significant variation in their size and ability. It is important to

take into account the type of school (i.e., high, middle, or elementary school) that will be served and the roadway(s) that access it (e.g., is it an elementary school accessible from a local residential street or is it a large or regional high school accessible from an arterial). School policies such as those that provide students with information about preferred bike routes and bicycle safety education are also important to consider. Even so, most children will not have the same understanding of the rules of the road as adult bicyclists, so facilities planned near schools may need special accommodations to provide for the needs of young bicyclists.

Recreation/Discretionary

Recreational and discretionary trips include trips made for exercise and/or leisure. Recreational users cover all age groups from children to adults to senior citizens, and will have varying levels of comfort when riding in traffic. Recreational trips can range from short trips within a neighborhood, to long rides lasting several hours and covering many miles. Children will generally ride within their neighborhood, with friends or parents, and on streets, sidewalks, or shared use paths. Adult recreational trips cover a wide range depending on the user's comfort and fitness level, with average adult users looking for moderate to slow-paced riding on quiet streets or shared use paths. A smaller number of adult bicyclists go on long-distance recreational trips, sometimes in groups or as part of a bike club, seeking out scenic and/or challenging terrain for sport and fitness, and sometimes at higher speeds.

Mountain bicyclists fall into the category of recreational riders but are considered a unique and independent group due to their regular use of natural surfaces in addition to paved surfaces. Mountain bikes are generally designed for use on both types of surfaces. This guide will cover the use of mountain bikes for recreational or utilitarian travel on paved surfaces but does not discuss mountain bike use on narrow or single track natural surfaces.

Utilitarian vs. Recreation

It is difficult to differentiate between utilitarian and recreational bicycling because the same transportation system can be used for both purposes. Just as roads are designed for various motor vehicle trip purposes, roads and pathways should be designed to facilitate various bicycle trip purposes.

People who use a bike for transportation get exercise they may not have otherwise had time for, or that would have taken additional time and expense, such as going to a fitness center. Unlike driving, which is typically not viewed as a recreational activity but rather as a means to an end, many people choose to bicycle because it achieves more than a single purpose, such as exercising while reaching a destination. Bicycling is a multifaceted recreational activity for millions of people nationwide, young and old, cutting across many socioeconomic and demographic categories. Some users may never go beyond recreational rides on shared use paths or low-volume roads, while others may advance their skills and become bicycle commuters. That is why understanding and planning for the needs and abilities of all bicycle users is important for designing successful bicycle networks.

Table 2-1 outlines common characteristics of recreational and utilitarian trips. The descriptions below provide a general idea of typical differences between trip purposes; however it should be noted that some trips combine purposes and do not fall into these distinct categories.

Table 2-1. Recreational Trips vs. Utilitarian Trips

Recreational Trips	Utilitarian Trips
Directness of route not as important as visual interest, shade, protection from wind.	Directness of route and connected, continuous facilities more important than visual interest.
Loop trips may be preferred to backtracking; start and end points are often the same.	Trips generally travel from residential to schools, shopping, or work areas and back.
Trips may range from under a mile to over 50 miles.	Trips generally are 1–10 miles in length.
Short-term bicycle parking is needed at recreational sites, parks, trailheads, and other recreational activity centers.	Short-term and long-term bicycle parking is needed at stores, transit stations, schools, and workplaces.
Varied topography may be desired, depending on the fitness and skill level of the bicyclist.	Flat topography is desired.
(Individuals) May be riding in a group.	(Individuals) Often ride alone.
(Individuals) May drive with their bicycles to the starting point of a ride.	Use bicycle as primary transportation mode for the trip; may transfer to public transportation; may or may not have access to a car for the trip.
Typically occur on the weekend or on weekdays before morning commute hours or after evening commute hours.	Some trips occur during morning and evening commute hours (commute to school and work), but in general bicycle commute trips may occur at any hour of the day.

2.3.2 Level of User Skill and Comfort

Another way to look at user types is by comfort and skill level. Rider age often influences comfort and skill level.

Rider Age

Adults do not have uniform cognitive and perceptual abilities. However, in comparison to children, adults generally can start and stop movement of their bicycle more quickly, are more visible to motorists, can interpret directionality of sounds with greater accuracy, and have a greater awareness of potential conflicts. In addition, most adults also operate motor vehicles and have the advantage of understanding the “rules of the road” from a driver’s perspective. Seniors are a special type of adult rider, who may ride at a slower pace and have longer reaction times when faced with sudden conflicts or objects in their path.

Children have a wide range of skills and cognitive capabilities. Generally, children are slower in recognizing and responding to rapidly changing situations. This leads to the possibility of crashes in common situations that children face when riding bicycles, such as crossing streets.

Children tend to:

- Have a relatively narrow field of vision.
- Have difficulties accurately judging the speed and distance of an approaching vehicle.
- Assume the driver of a motor vehicle can see them if they can see the vehicle.
- Have difficulty concentrating on more than one thing at a time.
- Have difficulty understanding risks.

Chapter 2: Bicycle Planning

- Have difficulty determining the direction of auditory input.
- Have little experience with the rules of the road because they do not drive motor vehicles.

These are development characteristics which change as children mature.

Experienced and Confident

This group includes bicyclists who are comfortable riding on most types of bicycle facilities, including roads without any special treatments for bicyclists. This group also includes utilitarian and recreational riders of many ages who are confident enough to ride on busy roads and navigate in traffic to reach their destination. However, some may prefer to travel on low-traffic residential streets or shared use paths. Such bicyclists may deviate from the most direct route to travel in their preferred riding conditions. Experienced bicyclists may include commuters, long-distance road bicyclists, racers, and those who regularly participate in rides organized by bicycle clubs.

Casual and Less Confident

This group includes a majority of the population, and includes a wide range of people: (1) those who ride frequently for multiple purposes; (2) those who enjoy bicycling occasionally but may only ride on paths or low-traffic and/or low-speed streets in favorable conditions; (3) those who ride for recreation, perhaps with children; and (4) those for whom the bicycle is a necessary mode of transportation. In order for this group to regularly choose bicycling as a mode of transportation, a physical network of visible, convenient, and well-designed bicycle facilities is needed. People in this category may move over time to the “experienced and confident” category. Table 2-2 outlines general characteristics of experienced versus casual bicyclists.

Table 2-2. Casual/Less Confident vs. Experienced/Confident Riders

Experienced/Confident Riders	Casual/Less Confident Riders
Most are comfortable riding with vehicles on streets, and are able to navigate streets like a motor vehicle, including using the full width of a narrow travel lane when appropriate and using left-turn lanes.	Prefer shared use paths, bicycle boulevards, or bike lanes along low-volume, low-speed streets.
While comfortable on most streets, some prefer on-street bike lanes, paved shoulders, or shared use paths when available.	May have difficulty gauging traffic and may be unfamiliar with rules of the road as they pertain to bicyclists; may walk bike across intersections.
Prefer a more direct route.	May use less direct route to avoid arterials with heavy traffic volumes.
Avoid riding on sidewalks. Ride with the flow of traffic on streets.	If no on-street facility is available, may ride on sidewalks.
May ride at speeds up to 25 mph on level grades, up to 45 mph on steep descents.	May ride at speeds around 8 to 12 mph.
May cycle longer distances.	Cycle shorter distances: 1 to 5 miles is a typical trip distance.

2.4 TYPES OF TRANSPORTATION PLANNING PROCESSES

The field of transportation planning has evolved over 20 years to reflect a growing body of experience, literature, and lessons learned nationwide. Bicycling has been integrated into planning processes throughout the country, in places large and small, including urban, suburban, and rural areas. This section of the guide covers the following types of planning processes:

- Comprehensive Transportation Plans
- Bicycle Master Plans
- Transportation Impact/Traffic Studies
- Small-Area and Corridor-Level Planning
- Project-Level Planning

2.4.1 Comprehensive Transportation Plans

Comprehensive or master transportation plans should include a bicycling component. These include Long-Range Transportation Plans, Highway System Plans, Highway Safety Plans, and Transportation Demand Management (TDM) Plans. The bicycle component of these plans should be of a similar level of detail as the motor vehicle components; for example, identifying specific short-term and long-term improvements, establishing funding priorities, and addressing policy issues. Public meetings for these plans should be designed to solicit input on bicyclists' needs and priorities, as well as input on all other modes. These plans should also provide recommendations for improving bicycle/transit connections.

In some cases, the bicycle element of the master transportation plan is a condensed version of a separate bicycle master plan (see below) and/or may incorporate the separate bicycle master plan by reference. Where this is the case, it is still important for the bicycle component to provide the same level of detail as the other modal elements of the plan.

2.4.2 Bicycle Master Plans

The purpose of a stand-alone bicycle plan is to identify the projects, policies, and programs that are needed in order to fully integrate bicycling as a viable mode of transportation within a community. Bicycle plans prepared by a state department of transportation (DOT) are often more focused on policy issues, while bicycle plans that are completed by local or regional agencies may focus on bicycle network planning, as well as policies and design practices that support bicycling.

A good bicycle plan starts from each community's current stage—some communities may be just beginning (“starting from scratch”) while others may be at a more advanced stage. It should address policy, infrastructure, and programming. For a community that is embarking upon bicycle planning for the first time, the focus may be on winning support for initial projects that will generate significant use or result in visible safety improvements, and help to build momentum for subsequent projects. For a community that has already implemented a partial bicycle network and has a growing number of engaged and active bicyclists, the focus may be on more challenging projects and programs. And for those communities in a more advanced stage with transportation systems that largely meet the needs of bicyclists, well-defined policies, new education and outreach programs, and a focus on critical gaps in the network may be appropriate. All communities should address policies that encourage and support bicycle trips.

Chapter 2: Bicycle Planning

A bicycle plan should be tailored to the unique conditions of the community which it serves. Bicycle plans for cities, suburbs, counties, regions, and states all differ significantly, depending on many factors including span of control (e.g., which roads or corridors are controlled or managed by the government entity), political support, available funding, and level of community engagement. Bicycle plans exist for every type of community: urban, suburban, rural, mountain, and resort. In fast-growing communities, bicycle plans may concentrate on policies, standards, and code language to guide future development, whereas plans for more built-out communities may be more concerned with the retrofitting of bicycle improvements at existing locations and analysis of potential off-street corridors.

A bicycle plan helps guide transportation departments to implement or improve bikeways and make other improvements to bicycling conditions as part of their routine roadway maintenance and “3R” (resurfacing, restoration, or rehabilitation) activities. For example, a routine pavement overlay may provide a convenient opportunity to add or improve bike lanes or paved shoulders, or consider changes to pavement markings that will improve bicycling conditions. When signals are upgraded, it is a good time to add bicycle-sensitive detectors. A bicycle plan can and should deal with the immediate needs for short-term improvements, balanced with longer term projects that could be decades from realization.

Public Process

To develop a plan that will enjoy community support, the process should include opportunities for the public, stakeholders, and other interest groups to participate and be heard. Public input should include a combination of strategies, such as public workshops, hearings, notices in the media, outreach events, and the formation of a Bicycle Advisory Committee. Effective committees report their findings to agencies and elected officials; are attended by transportation and enforcement officials, and welcome diverse viewpoints. Potential committee members may include planners, engineers, health and/or safety advocates, educators, business leaders, law enforcement personnel, bicycling advocacy groups, transit personnel, people with disabilities, elderly, and people who are economically disadvantaged. Local officials (elected and staff), who are responsible for implementation should participate in the process.

Outreach should be conducted to target and draw out the opinion of a broad cross section of the community, including experienced, casual, and novice bicyclists of all ages. These efforts could include a website, mailed surveys, school visits, or community bicycling audits to document bicycling resources and/or opportunities.

Coordination with Other Documents and Planning Processes

The plan should be coordinated with regional (county and Metropolitan Planning Organization) and state transportation plans (such as modal plans or corridor plans). While bicycle transportation may not always be the primary focus of these plans, the bicycle mode should be taken into consideration and should be addressed in an appropriate level of detail. For example, the implementation of bicycle recommendations often involves revisions to land development regulations, roadway design standards, and standard design details. These documents are typically updated on a periodic basis and these updates should address the travel needs of bicyclists where appropriate and as recommended in the bicycle master plan. Coordination is also needed with funding programs (such as the annual capital improvements program), and planning documents of other agencies (such as transit, and parks and recreation).

Phasing of Infrastructure Improvements

A phasing plan sets forward a strategy for improving conditions for bicycling over time, reflecting political realities, future development, funding opportunities, corridor constraints, and technical challenges. By identifying projects to be implemented in the short-, medium- and long-term, jurisdictions can focus initially on projects that are low-cost or need minimal infrastructure work, while simultaneously starting to plan, design, and seek funding and support for longer-term, more complex projects.

Short-term projects. Short-term projects can help to create early success and show significant progress in plan implementation. These projects are generally low-cost and easy to implement. Examples include traffic signal timing and/or detection adjustments; shared lanes; adjusting lane widths when restriping existing streets to create wide right lanes or bike lanes; removing travel lanes or parking and redistributing space to accommodate bike lanes; road repaving that includes bike lanes or paved shoulders; or installation of wayfinding signage or shared lane markings. These strategies will be discussed in more detail in the design chapters.

Medium-term projects. Medium-term projects may include major street repaving, facility reconstruction such as moving curbs, or funding as part of other capital improvement programs. These projects generally undergo a detailed infrastructure design study, are more complex to implement, and need time to secure funding and potentially right-of-way. Medium-term projects may also be those that only occur with new facility construction or old facility rehabilitation.

Long-term projects. Long-term projects generally represent investments of major capital funds; these projects are complex from a design or political standpoint. Examples can include bicycle bridges, elevated crossings, or underpass-style tunnels. These projects can be developed through new facility construction or facility rehabilitation.

To develop a phasing plan, several issues should be considered:

- **Bicycle Travel Demand:** To what degree will the bikeway generate significant usage? How many trip generators are within close proximity of the project, such as residential areas, schools, parks, transit centers, employment and commercial districts, churches, and park-and-ride facilities? There are several methods for forecasting bicycle travel demand, as described in Section 2.6.
- **Route Connectivity and Directness:** To what degree does this alternative fill in a missing gap in the bicycle network, or make a critical connection to a transit facility or other key destination?
- **Crash/Conflict Analysis:** Does the proposed improvement have the potential to alleviate a specific concern, such as an intersection with a history of bicycle crashes or conflicts?
- **Barriers:** How well does the alternative overcome barriers to bicyclists in the current transportation system? Barriers could include railroads, waterways, hills, canyons, and freeways. Bridges, overpasses, interchanges, and intersections that do not meet the needs of bicyclists can also be barriers.
- **Ease of Implementation:** How difficult will it be to implement this project? This criterion takes into account right-of-way, topographical, environmental, political, and economic constraints.

- ➔ **System Integration:** How well does the alternative link with other transportation modes? This criterion assesses how the proposed improvement fits within the overall transportation system and how it affects multimodal transportation.

Typical Plan Contents

A well-developed bicycle plan is comprehensive and should cover some, if not all, of the following topics (not necessarily in this order):

Introduction

The introduction of the plan lays a foundation and sets the context for the plan. It should provide a brief overview of the history and current status of bicycling in the jurisdiction, may discuss current or previous planning efforts that support bicycling, provide data on current levels of bicycling (along with historical data if available), and any other information that is needed to lay a foundation for the plan.

Vision, Goals, and Objectives

This section establishes what the plan hopes to accomplish. The vision statement should describe the jurisdiction in the future, once the goals and objectives have been fulfilled. Goals should be broad statements that address key focus areas, such as mobility, health, and the environment. Objectives identify more specific strategies for accomplishing the vision and goals.

Benchmarks or Performance Indicators

Benchmarks should be set in such a way that jurisdictions can measure results. In order to set a baseline for performance measures, collection of initial data may be needed (see Section 2.6.1). Performance measures should be as simple as practical, and should be fairly easy to measure. In some cases, existing data collection processes (such as roadway inventories) can be adjusted to collect data relevant to bicycle performance measures (i.e., shoulder width and pavement condition). Examples of benchmarks include the number of bikeway miles implemented, mode share percentage, rate of bicycle-motor vehicle crashes as compared to the number of bicycle trips, total number of bicycle-motor vehicle crashes, number of bike parking spaces, bike usage on a particular corridor, percentage of children bicycling to school, and others. Inclusion of outcome-oriented performance measures (such as usage counts and crash rates) is desirable to check effectiveness of current programs; purely inventory-oriented performance measures may not detect issues that need to be addressed.

Existing Conditions

The overview of existing conditions should take stock of the transportation infrastructure. The existing conditions analysis should include a general assessment of streets, roads, and highways by function, type, ownership, traffic volumes and speeds, width, and condition, as well as an inventory of existing bikeways, including shared use paths and trails outside the street system. Other items include bicycle parking conditions (quality, quantity, and location); crash data; proposed developments that may have a significant impact on bicycling; bike-transit integration (availability of bicycle racks on buses and policies regarding bicycles on transit vehicles); and education, encouragement, and enforcement efforts.

Recommended Bicycle Facilities

This component is discussed in more detail in the next section. Recommendations should reflect the community's needs, as well as the feasibility of projects in specific roadway corridors. An opportunistic approach is wise—the majority of bike plans recommend new facilities in locations where other roadway projects (such as repaving and shoulder widening) offer opportunities to implement bikeways less expensively. Projects should be identified in sufficient detail such that they can be integrated into a local capital improvement plan or advanced to a design phase. This should include, at a minimum, roadway name, beginning and end points, bikeway or improvement type, a description of the work needed, and the estimated cost. Bicycle parking needs can also be identified, as well as standards for placing bicycle parking facilities (see Chapter 6 for more information).

Recommended Policies/Design Guidelines

Recommendations for policy changes are a standard component of most bicycle master plans. This includes zoning and land development policies that support bicycling (such as higher densities of mixed-use development, neighborhood design that provides a high level of bicycle connectivity, bicycle parking ordinances, the need for commuter support facilities such as showers, etc.) Some bicycle plans also include design guidance that clarifies the jurisdiction's expectations in terms of bicycle facility design. This can be particularly helpful if the jurisdiction's current design guidelines do not address bicycle facilities; however, ultimately the goal should be to integrate bicycle design standards into other existing documents that cover roadway design, local subdivision and development codes, or other appropriate sources.

Recommended Education and Encouragement Programs

This section of the plan is very important, as there are typically many opportunities to improve conditions for bicyclists by improving behaviors. The education component should address issues such as bicycling-related information on appropriate jurisdictional websites; improvements in driver education programs and driver handbooks; routine inclusion of bicycle-related questions on driver license exams; safety information messages for motorists and bicyclists; and bicyclist training programs for children, youth, and adults. Education programs can help dispel myths, encourage courteous and lawful behavior among motorists and bicyclists of all ages, enhance the skill level of bicyclists, and improve motorist awareness. Education programs can be administered through a number of different agencies and interest groups, such as police departments, schools, libraries, bicycle clubs, and parks and recreation departments. The encouragement component can include commuter support programs and incentives, promotional activities oriented to neighborhoods and local business districts (e.g., a “shop by bike” program), campaigns to promote use of bicycles with transit, rides organized to introduce (or publicize benefits of) bicycling to a wider audience, and other activities to promote the more widespread practical application of bicycling (e.g., a “bike to work” program).

Enforcement Programs

This section of the plan should provide an overview or summary of enforcement of motorist and bicyclist violations and assess the need for improved enforcement of violations. This section should also address training of enforcement personnel to improve their understanding of the rights and responsibilities of bicyclists and duties of motorists towards bicyclists.

Implementation plan

This section should address short-, medium- and long-term recommendations, and should provide a phasing plan as described above. Short-term projects should include planning-level cost estimates for budgetary purposes. Funding sources should be identified, such as local or state transportation improvement programs, special federal funding programs, local capital improvement budgets, grants, and others. All types of projects—both infrastructure and non-infrastructure (such as education and encouragement programs) should be included in the phasing plan. For some plans, it may also be desirable to identify the agencies that are responsible for implementing the recommendations, and after project implementation it is important to evaluate improvements to determine if they achieved their desired results.

2.4.3 Transportation Impact/Traffic Studies

Transportation impact studies attempt to disclose information to stakeholders about potential impacts and benefits of new development. Although many studies in the past focused exclusively on motor vehicle impacts, today agencies have access to resources that can be used to measure the impacts on bicyclists (see Section 2.6). The National Environmental Policy Act (NEPA), the federal law governing environmental analysis, and many state environmental laws require a full disclosure of all transportation impacts, not just motor vehicle traffic impacts.

Thorough traffic studies evaluate impacts to all modes, including pedestrians, bicyclists, and transit, in addition to a discussion of on-site circulation and support facilities. Impacts to bicyclists are considered significant if:

- **A project disrupts existing bicycle facilities.** This can include adding new vehicular or bicycle traffic to an area experiencing safety concerns or a new development adjacent to an existing sensitive use, such as a school or park. Particular attention should be paid to on-street bicycle facilities on roadways with proposed driveways, and roadway widening or intersection improvements intended to augment motor vehicle capacity, which may reduce or eliminate shoulders or bike lanes.
- **A project interferes with proposed bicycle facilities.** This includes failure to dedicate right-of-way for planned on- and off-street bicycle facilities included in an adopted bicycle master plan, or failure to contribute toward construction of planned bicycle facilities along the project's frontage. Other examples are: a new roadway that severs a planned pathway connection, particularly when grade separation is desirable but is not planned for in advance, or a road design that constrains the inclusion of bicycle facilities or other bicycling improvements.
- **A project conflicts with adopted bicycle system plans, guidelines, policies, or standards.** This can include project designs that are in conflict with policy language, such as bicycle directness, connectivity, and network completeness.

Another consideration for bicycles in traffic studies is the evaluation of future off-site improvements to determine secondary impacts to bicycles. Impact studies typically include a set of improvements designed to reduce impacts to the transportation system. For example, a project may call for acceleration or deceleration lanes at a new driveway to reduce crashes and/or improve capacity. Thorough transportation impact studies explicitly analyze and mitigate secondary impacts on bicycling.

2.4.4 Small-Area and Corridor-Level Planning

Transportation plans that focus on specific roadway corridors should incorporate the needs of bicyclists along with all other users. The presumption in preparing these plans is that the needs of bicyclists will be included as a routine matter, and the decision to not accommodate them should be the exception rather than the rule.

During the development of small-area plans and corridor plans, bicycle access along and across roadways should be planned. An opportunistic approach should be used to incorporate improvements with the potential to reduce crashes for bicyclists along with other planned roadway improvements (see Section 2.5.2). In some cases, a roadway corridor or bridge replacement/reconstruction plan may create an opportunity to provide a new bicycle facility that does not necessarily connect to bikeways on either end of the corridor. However, bicycle accommodations should still be provided and should be designed with logical termini, because all bicycle networks begin with incremental improvements that eventually result in a connected network and transportation system that meet bicyclists' travel needs.

2.4.5 Project Level Planning—Approvals

Once a specific project is identified, key considerations become the types of approvals needed or desired to move the project to construction. Approvals needed by affected government agencies, stakeholders, and the general public should be identified early in the project development process. In some cases, projects require approval at the national level under NEPA. There are several factors that trigger the need for NEPA approval, most commonly the use of federal funding or impacts to federal lands. In many instances, whether or not NEPA approval is needed, state and local environmental approvals as well as other permits may be required. Often times these approvals require regular updates to, and input from, the general public and key stakeholders.

During the project development and/or approval process, there is often a need to develop and evaluate design alternatives. In some cases, NEPA approval requires the evaluation of all practical alternatives that accomplish the purpose and need of the project. Analytical tools (see Section 2.6) can aid in evaluating alternatives by comparing relatively small differences in design and presenting them in a format that is relatively easy to understand.

2.5 PLANNING BICYCLE TRANSPORTATION NETWORKS

The core element of a bicycle plan will be the bicycle transportation network, composed of a connected, comprehensive system of paved shoulders, bike lanes, shared lanes, bicycle boulevards, bike routes, and shared use paths. This section describes how to develop a bicycle network plan.

2.5.1 Deciding Where Improvements Are Needed

All roadways should be accessible by bicycle, except where bicycle travel is specifically prohibited. Whenever roads are reconstructed or constructed, appropriate bikeways should be included to accommodate bicyclists' needs. However, technical, political, and financial realities may mean that not all roads can be immediately retrofitted or designed with the best or most appropriate bikeway. Thus, choices should be made regarding which improvements receive priority, and what level of accommodation each roadway will receive. Making these choices is both an art and a science. The science relies on use of standards, guidelines, and technical analysis tools, while the art

Chapter 2: Bicycle Planning

integrates local knowledge, engineering judgment, and public input. Technical guidance on the design of different bikeways is provided in Chapters 4 and 5 of this guide.

Factors to consider when deciding where improvements are needed to develop a connected bicycle transportation network include:

- **User Needs**—Balancing the full range of needs of current and future bicyclists.
- **Traffic Volumes, Vehicle Mix, and Speeds**—Motor vehicle traffic volumes, vehicle mix, speeds, and driveways should be considered along with the roadway width. Some bicyclists will avoid roadways with high speeds and high volumes of traffic and many driveways unless they are provided with a facility that offers some degree of separation from traffic. Also, some bicyclists will avoid roadways with high truck volumes. By contrast, people who regularly use a bicycle for transportation often use main roadways because their directness and higher priority at intersections typically make them more efficient routes. In many cases, the best approach is to improve the arterial roadway to accommodate bicyclists, but to also provide a parallel route along streets with lower speeds and traffic volumes that is convenient to follow and offers a similar level of access to destinations. High traffic volumes and speeds should not be used as justification for not accommodating bicyclists because many of these roadways are the only ones that connect parts of communities.
- **Overcoming Barriers**—Overcoming constraints and physical barriers such as freeways or waterways should be a top priority when developing a bicycle network. A single major barrier (e.g., difficult intersection, bridge without bike lanes or paved shoulder) can render an otherwise attractive bikeway undesirable. Input from local bicyclists, along with a field analysis of major highway crossings, railroads, and river crossings, can help to identify major barriers. Barriers can also include difficulties for bicyclists in utilizing other modes of transportation to link trips.
- **Connection to Land Uses**—Bikeways should allow bicyclists to access key destinations. They should connect to employment zones, parks, schools, shopping, restaurants, coffee and ice cream shops, sports facilities, community centers, major transit connections, and other land uses that form the fabric of a community.
- **Directness of Route**—A bikeway should connect to desirable locations with as few detours as practical. For example, does a bicyclist have to travel out of his or her way on a route with many turns to reach a freeway overpass? Multiple turns can disorient a rider and unnecessarily complicate and lengthen a trip.
- **Logical Route**—Does the planned bicycle network make sense? A network should include facilities that bicyclists already use, or have expressed interest in using.
- **Intersections**—Bikeways should be planned to allow for as few stops as practical, as bicycling efficiency is greatly reduced by stops and starts. If bicyclists are required to make frequent stops, for example, along streets with stop signs every block, they may avoid the route or disregard traffic control devices. Signalized intersections with very short green times (such as those on low-priority streets) can lead to disregard for traffic

control. At major streets, crossings should be carefully planned and managed to reduce crashes and improve operations for all travelers and modes. Each additional intersection can present a potential for additional crashes.

- **Aesthetics**—Scenery is an important consideration along a facility, particularly for a facility that will serve a primarily recreational purpose. Trees can also provide cooler riding conditions in summer and can provide a windbreak. Bicyclists tend to favor roads with adjacent land uses that are attractive such as campuses, shopping districts, and those with scenic views.
- **Spacing or Density of Bikeways**—A bicycle network should be planned for maximum use and comfort, and thus should provide an appropriate density relative to local conditions. Some bicycle network plans have set a goal to provide a bikeway within one-fourth of a mile of every resident.
- **Safety**—Analysis of crash data and reviews of crash reports may also aid in identifying where improvements to the bicycle transportation network are recommended based upon safety experience.
- **Security**—Security issues are important to consider especially for sections of shared use paths that are not visible from roads and neighboring buildings.
- **Overall Feasibility**—Decisions regarding the location of new bikeways may also include an overall assessment of feasibility given physical or right-of-way constraints, as well as other factors that may impact the cost of the project. While funding availability may influence decisions, it is essential that a lack of funds not result in a poorly-designed or constructed facility. The decision to implement a bicycle network plan should also be made with a conscious, long-term commitment to a proper level of maintenance. Facility selection should seek to maximize user benefit per dollar funded. Cost-benefit analysis is covered in Section 2.6.6.

While every street will serve as a bicycle facility to some extent, concentrating bicycle trips along specially treated corridors can help to attract new bicyclists and reduce crashes for all modes.

A context sensitive design approach is important in all aspects of roadway design. Simply applying standards, without understanding how they will function, the local context, or the future design intent, can lead to inappropriate and underused facilities. A core value of context sensitive solutions is to provide an effective facility for both the user and the surrounding community and a project built in harmony with adjacent land uses, preserving important environmental, historic, and aesthetic features of the area. Context sensitive designs should address the needs of bicyclists and should support measures that reduce the impact of motor vehicles on the environment.

2.5.2 Practical (Opportunistic) Approach to Network Planning

Many of the most successful bike plans have been implemented through a pragmatic approach involving phasing of improvements and opportunistic partnerships with other projects and government departments/agencies. Examples of this type of approach include:

Chapter 2: Bicycle Planning

- Bike lane implementation as part of resurfacing, reconstruction, and routine maintenance overlays. Many communities have coordinated their bikeway plans and their street repaving programs to create bike lanes through the reallocation of street space during routine paving projects.
- “Complete Streets” Policies. Integration of bikeways in routine public works projects including highway and transit projects. Cost-effective improvements can be made by systematically including bikeways in projects as a matter of policy.
- Bikeway implementation via private-sector development activity. New developments, including mixed-use projects, residential developments, and urban infill projects provide significant opportunities for including bikeways in the local planning process.
- Bikeway implementation in coordination with major capital projects. Bikeways can successfully be included in bridges, freeways, light rail projects, transit stations, and other capital projects.
- Development of shared use paths in corridors with utilities or other infrastructure improvements. Co-location of water, sewer, communications, power, and other utilities can create cost-sharing and revenue opportunities for bikeways.
- Rails-to-Trails and Rails-with-Trails Projects. Active, abandoned, and rail-banked corridors are frequently used to create shared use paths.
- Training for maintenance bureaus, planning boards, utility managers, school districts, transit districts, and other agencies so that they are aware of the opportunity to implement bicycle facilities as part of their routine activities.

Choosing an Appropriate Facility Type

Although incorporating bicyclists’ needs into the design of major transportation corridors can be challenging, the reality of planning bikeways in built environments means that roadways constitute the majority of a bicycle network. Whenever streets are constructed or reconstructed, appropriate provisions for bicyclists should be included consistent with federal policy. Technical information on the design of different bikeways is provided in Chapters 4 and 5. The bikeway design options are:

- Shared lanes,
- Marked shared lanes,
- Paved shoulders,
- Bike lanes,
- Bicycle boulevards, and
- Shared use paths.

Bike routes are not included in the list above because they represent a designation, rather than a facility type. See Section 2.5.3 on “Wayfinding for Bicycles.”

Considerations

The best application of each of these facilities combines experience with data analysis, engineering judgment, and budget constraints. Across the nation, state and local guidelines vary considerably depending on local preferences, experience, and conditions. Thus, this guide does not provide strict rules as to when to employ a bike lane versus a shared lane.

However, the urban centers in the United States that have seen the highest levels of bicycle use are those that have built a network of bike lanes and shared use paths as the backbone of their system. A very effective tool for encouraging bicycling is to provide a visible network of bikeways; it is harder (though not impossible) to attract people to use something not readily apparent. Selection of an appropriate bikeway should be based on the following information:

- Road function (arterial, local),
- Traffic volume,
- Speed,
- Traffic mix (e.g., truck percentage),
- Expected users (e.g., is one type of user expected to dominate, such as children bicycling to school),
- Road conditions (lane widths, total roadway width, conditions at intersections, and parking demand),
- Driveways or access points,
- Topography,
- Existing and proposed adjacent land uses, and
- Cost.

Bicycle quality of service tools (see Section 2.6.2) can be helpful in determining the appropriate facility choice, as they combine several of the factors listed above and can be used to determine the amount of lateral separation that is needed between bicycles and motor vehicles at increasing speeds. However, facility choice should also be appropriate given the type of street or corridor involved, and the potential for conflicts at intersections. Table 2-3 outlines general considerations for each facility type.

Multiple Facility Types on a Single Corridor

Corridors that effectively accommodate bicyclists often combine multiple facility types, each type being used where appropriate. For example, a shared use path can connect to a bicycle boulevard to create a continuous corridor. A corridor may start with bike lanes, travel along a bicycle boulevard, and then transition back to bike lanes. Throughout the network, transitions between facility types should be functional and intuitive.

As indicated in Table 2-3, shared use paths can range from short inter-street connections to long corridor routes. Shared use paths can attract new users, and can be an asset in connecting neighboring jurisdictions and providing community cohesion. To be successful, access via the local street network is crucial, with appropriate bikeways available on those connecting streets.

Chapter 2: Bicycle Planning

Table 2-3. General Considerations for Different Bikeway Types

Type of Bikeway	Best Use	Motor Vehicle Design Speed	Traffic Volume	Classification or Intended Use	Other Considerations
Shared lanes (no special provisions)	Minor roads with low volumes, where bicyclists can share the road with no special provisions.	Speeds vary based on location (rural or urban).	Generally less than 1,000 vehicles per day.	Rural roads, or neighborhood or local streets.	Can provide an alternative to busier highways or streets. May be circuitous, inconvenient, or discontinuous.
Shared lanes (wide outside lanes)	Major roads where bike lanes are not selected due to space constraints or other limitations.	Variable. Use as the speed differential between bicyclist and motorists increases. Generally any road where the design speed is more than 25 mph.	Generally more than 3,000 vehicles per day.	Arterials and collectors intended for major motor vehicle traffic movements.	Explore opportunities to provide marked shared lanes, paved shoulder, or bike lanes for less confident bicyclists.
Marked shared lanes	Space-constrained roads with narrow travel lanes, or road segments upon which bike lanes are not selected due to space constraints or other limitations.	Variable. Use where the speed limit is 35 mph or less.	Variable. Useful where there is high turnover in on-street parking to prevent crashes with open car doors.	Collectors or minor arterials.	May be used in conjunction with wide outside lanes. Explore opportunities to provide parallel facilities for less confident bicyclists. Where motor vehicles allowed to park along shared lanes, place markings to reduce potential conflicts with opening car doors.

Table 2-3. General Considerations for Different Bikeway Types (continued)

Type of Bikeway	Best Use	Motor Vehicle Design Speed	Traffic Volume	Classification or Intended Use	Other Considerations
Paved shoulders	Rural highways that connect town centers and other major attractors.	Variable. Typical posted rural highway speeds (generally 40–55 mph).	Variable.	Rural roadways; inter-city highways.	Provides more shoulder width for roadway stability. Shoulder width should be dependent on characteristics of the adjacent motor vehicle traffic, i.e. wider shoulders on higher-speed and/or higher-volume roads.
Bike lanes	Major roads that provide direct, convenient, quick access to major land uses. Also can be used on collector roads and busy urban streets with slower speeds.	Generally, any road where the design speed is more than 25 mph.	Variable. Speed differential is generally a more important factor in the decision to provide bike lanes than traffic volumes.	Arterials and collectors intended for major motor vehicle traffic movements.	Where motor vehicles are allowed to park adjacent to bike lane, provide a bike lane of sufficient width to reduce probability of conflicts due to opening vehicle doors and objects in the road. Analyze intersections to reduce bicyclist/motor vehicle conflicts.

Chapter 2: Bicycle Planning

Table 2-3. General Considerations for Different Bikeway Types (continued)

Type of Bikeway	Best Use	Motor Vehicle Design Speed	Traffic Volume	Classification or Intended Use	Other Considerations
Bicycle boulevards	Local roads with low volumes and speeds, offering an alternative to, but running parallel to, major roads. Still should offer convenient access to land use destinations.	Use where the speed differential between motorists and bicyclists is typically 15 mph or less. Generally, posted limits of 25 mph or less.	Generally less than 3,000 vehicles per day.	Residential roadways.	Typically only an option for gridded street networks. Avoid making bicyclists stop frequently. Use signs, diverters, and other treatments so that motor vehicle traffic is not attracted from arterials to bicycle boulevards.
Shared use path: independent right-of-way	Linear corridors in greenways, or along waterways, freeways, active or abandoned rail lines, utility rights-of-way, unused rights-of-way. May be a short connection, such as a connector between two cul-de-sacs, or a longer connection between cities.	N/A	N/A	Provides a separated path for non-motorized users. Intended to supplement a network of on-road bike lanes, shared lanes, bicycle boulevards, and paved shoulders.	Analyze intersections to anticipate and mitigate conflicts between path and roadway users. Design path with all users in mind, wide enough to accommodate expected usage. On-road alternatives may be desired for advanced riders who desire a more direct facility that accommodates higher speeds and minimizes conflicts with intersection and driveway traffic, pedestrians, and young bicyclists.

Table 2-3. General Considerations for Different Bikeway Types (continued)

Type of Bikeway	Best Use	Motor Vehicle Design Speed	Traffic Volume	Classification or Intended Use	Other Considerations
Shared use path: adjacent to roadways (i.e., sidepath)	Adjacent to roadways with no or very few intersections or driveways. The path is used for a short distance to provide continuity between sections of path on independent rights-of-way.	The adjacent roadway has high-speed motor vehicle traffic such that bicyclists might be discouraged from riding on the roadway.	The adjacent roadway has very high motor vehicle traffic volumes such that bicyclists might be discouraged from riding on the roadway.	Provides a separated path for nonmotorized users. Intended to supplement a network of on-road bike lanes, shared lanes, bicycle boulevards, and paved shoulders. Not intended to substitute or replace on-road accommodations for bicyclists, unless bicycle use is prohibited.	Several serious operational issues are associated with this facility type. See Sections 5.2.2 and 5.3.4 for additional details.

2.5.3 Wayfinding for Bicycles

Developing a bicycle wayfinding system that provides clear user information and navigational instructions is a complex endeavor in which the planner or designer must carefully consider the routes that bicyclists prefer, balancing the need for good bicycling conditions with the need for direct access to destinations. Input from local bicyclists can be very helpful when planning new bicycle routes. In general, it is advisable to start with a single route, or a simple network, and then build upon the network over time, rather than to attempt to implement an extensive network of multiple, interconnecting routes all at once.

To achieve a successful wayfinding system, the planner should conduct careful field work to identify effective routes and determine where signs should be placed, so that bicyclists following routes do not go off course. It is very important for the route planner to approach the task from the perspective of the bicyclist who will be following the signs to reach their destination.

Part 9 of the MUTCD (2) provides the basic guidelines for design of wayfinding signage systems for bicycle networks. This includes three types of bicycle route designation and guide signs (see Figure 2-1), including D Series Route Signs, M1-8 Series Route Signs, and M1-9



Figure 2-1. Typical Wayfinding Signs

Route Signs. Section 4.11 provides additional information on bicycle guide/wayfinding signs. Colored pavement is another wayfinding strategy that can be used, especially in urban areas. Section 4.7.2 provides more details on the use of colored pavement.

Many communities find that a wayfinding system for bicycles is a component of a bicycle network that enhances other encouragement efforts, because it provides a visible invitation to new bicyclists, while also encouraging current bicyclists to explore new destinations.

2.6 TECHNICAL ANALYSIS TOOLS THAT SUPPORT BICYCLE PLANNING

A number of technical analysis tools exist to help with planning bikeways, bicycle networks, and roads without bikeways. These will be addressed in the following sections, and include:

- Data collection and flow analysis,
- Quality of service tools,
- Safety analysis,
- Bicycle travel demand analysis,
- GIS-based data collection/network planning, and
- Cost-benefit analysis.

The models and tools described in this section provide planners and decision-makers with methods of synthesizing large amounts of complex information. They can also provide useful graphical tools to communicate conditions and opportunities. No one model or tool solves all problems or answers all questions; each can provide assistance to the planning effort in a different way.

2.6.1 Data Collection and Flow Analysis

Many of the demand projection techniques described below either need, or would benefit from, bicyclist count data. Cities routinely collect, analyze, and use various data on motor vehicle traffic (e.g., average daily volumes, peak hour volumes, turning movements, and speed) to determine such items as number of travel or turn lanes, and signal timing. Similarly, bike-related data collection is an important part of understanding, planning, and operating a bicycle network. Bicycle counts should be considered at the state, regional, and local levels to complement bicycle planning and performance measurement. Bike counts and movement analysis can be used for the following:

- To identify corridors where current use and potential for increased use is high.
- To understand patterns of usage both before and after a facility is installed.
- To forecast bicycle travel demand (see Section 2.6.5) to and from colleges, universities, schools, parks, and employment centers.
- To track community-wide bicycle use over time, on particular corridors, as part of multimodal trips, or in response to specific factors, such as increasing density of bikeways (this can include bicycle counts on specific roadways, as well as tracking bike-on-bus boardings or bike parking usage).
- To project increases in bicycle use in future years.

- To analyze specific travel patterns, such as bicyclists' positioning or movements at intersections, sidewalk usage, compliance with traffic control devices, use of hand signals, and interaction with motorists.
- To analyze equipment trends such as the wearing of helmets and use of front or rear lights and reflectors. Such an analysis can be helpful in determining if a campaign to encourage helmet use, for example, was successful.
- To analyze demographic trends, such as male versus female or rider age.

By conducting counts over several years, event-specific spikes will be less likely to skew the results. Counts taken in multiple seasons can help to determine seasonal fluctuation. In addition, existing conditions should be taken into account when conducting bicycle counts to estimate facility usage. The condition of the bicycle environment can be a deterrent to bicyclists that might otherwise use a particular corridor, and thus not to be counted. Per the direction of the Institute of Transportation Engineers (ITE) *National Bicycle and Pedestrian Documentation Project* (8), a bicycle count methodology has been established that will give jurisdictions across the nation access to a rich dataset for analysis. For count forms and directions, refer to the *National Bicycle and Pedestrian Documentation Project* website (8).

2.6.2 Quality of Service (or Level of Service) Tools

Quality of service (or Bicycle Level of Service [Bicycle LOS]) tools can be used to inventory and evaluate existing bicycling conditions, or to forecast future conditions for bicycling under different roadway design scenarios. A variety of bicycle compatibility criteria have been developed since the early 1990s to quantify how compatible a roadway is for accommodating safe and efficient bicycle travel. More information on this topic can be found in the *Highway Capacity Manual* (11). Applications of these models include:

- Documenting current conditions on an existing roadway.
- Documenting current conditions on an existing shared use path.
- Conducting a benefits comparison among proposed bikeway/roadway cross sections.
- Identifying roadway restriping or reconfiguration opportunities to improve bicycling conditions.
- Prioritizing and programming roadway corridors for bicycle improvements.
- Creating bicycle suitability maps.
- Documenting improvements in a corridor or system-wide bicycling conditions over time (typically means data to be managed in a GIS environment).
- Determining impacts of proposed roadway projects on bicyclists.

Although the term Level of Service (LOS) implies similarity to the vehicular intersection delay rating system established in the *Highway Capacity Manual*, Bicycle LOS evaluates bicyclists' perceived safety and comfort with respect to motor vehicle traffic while traveling in a roadway corridor. To evaluate Bicycle LOS, a mathematical equation is used to estimate bicycling conditions in a shared roadway environment (9). This modeling procedure calculates a user comfort rating (A through F, A being the best and F, the worst), from such factors as curb lane width, bike lane

widths and striping combinations, traffic volumes, pavement surface condition, motor vehicle speeds, presence of heavy vehicle traffic, and on-street parking.

Bicycle LOS provides a score for each roadway that indicates how comfortable a “typical” adult bicyclist would feel while riding along that roadway during peak travel conditions. Some bicyclists may feel more or less comfortable than the Bicycle LOS calculated for a roadway. A poor Bicycle LOS grade does not mean that bikes should be prohibited on a roadway, rather it means that the roadway is a candidate for improvements to better accommodate bicyclists.

It is important to distinguish between a segment-based and intersection-based LOS. The models discussed above do not address intersection LOS. Intersections can be significant barriers to bicycling, and a corridor with relatively high Bicycle LOS along its segments can be less suitable due to intersections that have a low Bicycle LOS. Factors that impact intersection LOS for bicycles include lane widths, motor vehicle speeds, crossing distance, signal timing, and conflicts with turning vehicles.

The detailed knowledge of local bicyclists and bicycle planners should be used to corroborate Bicycle LOS model results. The Bicycle LOS model provides a means to quantify the perceived safety and comfort of bicyclists. Perceived safety and comfort of bicyclists often serves as a surrogate for the crash experience of bicyclists when crash data are not available. To measure the actual safety of bicyclists, analysis of bicycle crash data is needed.

2.6.3 Safety Analysis

Analysis of crash trends, particularly at intersections or along corridors where most bicycle-motor vehicle related crashes occur, is one of several factors that are helpful when selecting and designing appropriate bikeways (see Section 2.5.1). By analyzing crash data, planners seek to target specific areas, understand the combination of conditions that could be creating high crash rates, profile corridors with high crash rates, compare the characteristics of one bikeway or potential bikeway to another, and focus attention most effectively. When using crash data to determine potential locations for improvements to reduce crash frequency or severity, it is important to review at least three years of data in order to account for anomalies that might occur in a single year. However, there are several limitations associated with crash data, as well as difficulties accessing data. They include:

- Bicycle-related crashes are generally underreported, especially those resulting in only minor injuries (10).
- Crash data fails to capture locations characterized by frequent near-misses.
- Bicycle count and exposure data is often lacking so it is difficult to calculate a crash rate.
- Crash databases typically only include bicycle-motor vehicle crashes; bicycle crashes that do not involve a motor vehicle (e.g., bicycle crashes influenced by poor surface conditions) and bicycle crashes that occur on shared use paths typically are not recorded in crash databases.
- Non-traditional data sources, such as hospital records, may help create a more comprehensive picture of crashes at a location or along a corridor, but are time consuming to collect and analyze (10).

- Existing data can be difficult to interpret, is often scattered through different systems and departments, and does not always yield enough crashes at a single location to produce statistically reliable results.
- If the data has not been sorted and mapped (such as through the *Pedestrian and Bicycle Crash Analysis Tool* described below), the process of analyzing data can involve significant effort.
- Depending upon the methods used to report bicycle crashes, it can be difficult to determine the actual location or cause of the crash, or to glean other helpful information (such as the age of the bicyclist, or whether the bicyclist was wearing a helmet).

Pedestrian and Bicycle Crash Analysis Tool

The *Pedestrian and Bicycle Crash Analysis Tool* (PBCAT) is a software product developed by the Federal Highway Administration that can be used to develop and analyze a database containing details associated with crashes between motor vehicles and pedestrians or bicyclists (5), (6). The database is typically built using detailed crash reports, which are generated by law enforcement agencies. PBCAT is a valuable tool, because in addition to identifying crash locations, it identifies the crash type (among a list of common reasons for crashes) and recommended countermeasures. During project planning, PBCAT can help to identify specific locations where additional design measures may be needed to reduce bicycle crash frequencies. More information on PBCAT can be found at the Pedestrian and Bicycle Information Center website (3).

Intersection Safety Index

The *Bicycle Intersection Safety Index* can be used to evaluate individual intersection approaches and crossings (1). This method helps determine which intersections or approach legs should be prioritized for further evaluation and may be helpful for prioritizing improvements to reduce crash frequency and severity. The safety index score is based on a number of measurable characteristics of the intersection (number of lanes, configuration of turn lanes, presence of bike lane, type of traffic control, and traffic volume among others). More information on the *Bicycle Intersection Safety Index* can be found at the Pedestrian and Bicycle Information Center website (4).

2.6.4 GIS-Based Data Collection/Network Planning

Geographic Information Systems (GIS) are a useful tool during the development of a bicycle network plan. GIS mapping enables the planner to combine a visual representation of a bicycle network with large quantities of background data that are needed for each individual roadway or pathway segment within the network. This enables a level of comprehensive analysis that is more efficient and enables the planner to track progress over time as roadways are improved with new bicycle facilities.

GIS mapping is typically used to catalogue essential data that is collected either from other databases (such as average daily traffic or traffic speeds), from aerial photography (such as presence of a shoulder on the roadway), or through field data collection (such as pavement condition or lane widths). GIS mapping can also be used to develop network maps that indicate the type of facility that is recommended for each roadway segment, as well as the proposed method of accomplishing the improvement (such as lane width reductions, addition of new pavement, etc.). Analysis in a GIS-based environment is needed in order to apply systematic evaluation tools such as Bicycle LOS. Crash data can also be analyzed efficiently in a GIS database by looking at different layers

of data; for example, a planner can view the locations of crashes on a map along with background information on each crash (fault, time of day, age of bicyclist, etc), and the map can display transit routes and stops.

2.6.5 Bicycle Travel Demand Analysis

Understanding existing and potential levels of bicycling is important in bikeway planning, particularly if there is a need to prioritize among many potential capital investments in bicycle infrastructure. Measuring demand is less important when opportunities arise to incorporate the needs of bicyclists in roadway resurfacing and rehabilitation projects, since routine accommodations for bicycling should be a standard operating procedure.

Evaluating bicycle travel demand shares some similarities to motor vehicle travel demand modeling. Both forecast future needs based on objective data inputs. However, bicycle travel demand should also account for latent demand (demand that is not apparent, but underlying) because existing conditions on a roadway are often a significant deterrent to travel. Therefore, bicycle travel demand methods make assumptions regarding how many people would choose to bicycle along a given corridor if conditions were conducive to bicycling. This is, at best, a very inexact science due to the many other casual factors involved in the decision to ride a bicycle. Those factors include the level of connectivity of the overall bicycle network, the availability of needed modal connections, availability of bicycle parking, typical trip lengths, and seasonal variations.

Compared to the vast amount of data collected for motor vehicles, there are virtually no widely-accepted sources of data available to evaluate the demand for bicycling. The *ITE Trip Generation Manual* (7) is widely used for data on trip generation, distribution, and other motor vehicle considerations; however, no such system exists for bicycles.

Choosing the correct tool to measure latent demand is dependent upon the study's purpose, availability of data, ease of analysis, desired accuracy, sensitivity to design factors, and whether the target of the evaluation is a single facility or an entire network. The tools vary in their qualitative versus quantitative approach to bicycle travel demand. The former depends on logic, examples, public input, and experience, while numbers will drive the latter. The qualitative approach generally involves less time and little data collection, while a quantitative approach may involve a high level of demographic data collection, user and household surveys, and proficiency with data and statistical analysis.

Types of travel demand analysis include:

- Comparison studies
- Sketch plan methods
- Market analysis/land use models
- Discrete choice survey models

Comparison Studies

This type of study involves comparing an existing facility with a proposed one. Adjustments for demographic and land use differences can refine the study. Steps include creating a list of comparable facilities and analyzing their similarities to the project location in terms of land use types, population density; income; availability of alternative routes; and presence of schools, retail shops, parks, employment, transit availability, and network continuity. When the comparison facility

is selected, counts conducted will determine the level of use. Adjusting for differences between the two locations completes the process. An ideal case study will have data taken before and after implementation to compare expected with actual increases in bicycling. This method works well when similar facilities for comparison exist within the region or market.

Sketch Plans

Sketch plan methods depend on rules of thumb and simple calculations to derive a demand estimate. For example, many communities need a demand estimate for a proposed trail or bikeway as part of a funding request. This method uses regional or national datasets including the National Census, Journey to Work data, or the National Household Trip Survey to establish a baseline of potential corridor users. Refinements are then made based on a variety of factors, such as percentage of students or youth within the corridor area, seasonal variations, bike-transit trips, or utilitarian trips. Sketch plan methods are typically less reliable than other methods, such as comparison studies or market analysis tools.

Market Analysis/Land Use Tools

Modeled after land-use projection tools, these GIS-based approaches analyze demographic and land-use conditions to evaluate existing conditions and project future potential bicycle demand across a zone or community. Factors analyzed include street connectivity, destination land uses, topography, barriers, crash statistics, demographic data, and bicycle network density and quality. By comparing these existing conditions to perfect or “ideal” conditions, practitioners can match improvements to areas with the highest potential demand.

Discrete Choice Models

Discrete choice models rely on surveys to ask people to catalogue their trips or predict their travel behavior if conditions were to change. They can be used to measure mode split based on the cost of travel time, fiscal cost, and convenience and can feed into regional travel models.

2.6.6 Cost-Benefit Analysis

Planning agencies can use cost-benefit analysis to quantify the impacts of bicycle facilities and discuss them in easily understood terms. Costs are generally divided into one-time capital construction costs and ongoing annual operating costs. Application of a cost-benefit methodology to bicycle projects can allow comparison to motor vehicle and transit projects. A comparative cost-benefit analysis of planned bikeways can help prioritize projects that will have a high benefit-to-cost ratio. A cost-benefit analysis tool for bicycle facilities can be found at the Pedestrian and Bicycle Information Center website (13).

2.6.7 Key Role of Public Input in the Process

All of the tools described above contribute to the planning process. However, no tool is a substitute for public input. Bicyclists in the community have the best knowledge of current conditions as well as specific opinions on areas that need new facilities or current facilities that need improvement. Opinions and feedback of interested users who do not ride extensively (or at all) should also be sought to provide input regarding which facilities or programs they need in order to start riding. Therefore, it is important to identify ways to gain feedback from both bicyclists and non-bicyclists in the community.

2.7 INTEGRATING BICYCLE FACILITIES WITH TRANSIT

The relative ease of access to transit often determines a traveler's decision whether or not to ride transit. Programs that educate the public about connections between bicycling and transit can promote both modes simultaneously. Linking bicycles with transit overcomes such barriers as lengthy trips, personal security concerns, poor weather, and riding at night or up hills.

Safe and convenient routes that serve bicyclists should be viewed as essential support strategies in increasing transit ridership. The “catchment” area for bicycle-to-transit trips is typically two to three miles. This is the area within which bicyclists will choose to bicycle to or from transit as a segment of a longer trip. There are four main components of bicycle-transit integration:

1. Facilitating bicycle access on transit vehicles;
2. Offering bicycle parking at transit locations;
3. Improving bikeways to transit; and
4. Promoting usage of bicycle and transit programs.

Bicycle transport on transit vehicles should include access during all hours of operation with enough spaces to meet the demand. A number of parking and bicycle-on-transit storage systems are available and in use. Transit stations should allow easy access for bicyclists; this may include installation of an elevator, retrofitting a staircase with a bicycle wheel channel, or providing access by ramps.

On highways and streets, combined bicycle and transit facilities, such as shared lanes or bike lanes adjacent to transit corridors, sometimes create design challenges for practitioners. As the bus pulls into a conventional, sidewalk stop, it crosses the area where bicyclists are most likely to ride (whether there is a designated bike lane or not). Bicyclists then typically pass the bus on the left. Once the bus has completed on- and off-boarding passengers, it crosses into the travel lane and the cycle repeats itself at each subsequent stop. This “leap-frog” effect is a fact of urban bicycle travel and is sometimes difficult to avoid; however, effective countermeasures include proper pavement markings for bike lanes at bus stops, provision of bike lanes on the left-hand side of the roadway on one-way streets, combined bus/bike lanes, added training for bus drivers, and educational materials for bicyclists (which can be displayed on the outside of the bus).

Bicycle parking at transit stops and stations should be well promoted and secure, with enough spaces available to meet the demand. Ideally, parking will include both short-term and long-term facilities.

Bicycle and transit integration continues to expand. Other areas of potential growth in bicycle and transit integration include:

- Emerging ways of accommodating bicycles on transit, such as high-capacity, on-bus bicycle racks, bicycle-on-vanpool services, and new methods for storing bicycles on rail cars.
- Emerging techniques for storing bicycles at transit hubs, such as high-capacity bike parking at transit stations and full-service staffed bicycle parking.
- Better access for bicyclists within transit stations and wayfinding signs for navigation to and from transit stations.
- More on-road bicycle and transit facilities, such as shared bus/bicycle streets and lanes.

- New methods of bicycle and transit education, such as on-bus bicycle rack demonstrations for bicyclists and share-the-road training for bus drivers.
- More coordination with local jurisdictions to provide bicycle access improvements in areas around transit stops and including bicycle access information on transit maps.
- Adjusting routes to maximize bicycle usage.
- New performance measures for evaluating the effectiveness of bicycle services.

Many transit agencies throughout the United States have participated in local bicycle planning efforts and interface with bicycle advocacy organizations. Many view efforts to better accommodate bicyclists as positive public marketing components and as a method of increasing the viability of transit (12). Integrating transit and bicycling involves bringing bicycle advocates, transit providers, local agencies, and state DOTs together to plan routes, intersections, and facilities jointly to address all potential transportation issues. This allows the owner and operator of the transportation facilities to incorporate bicycle and transit needs simultaneously to decrease the likelihood that the different modes will conflict with each other.

REFERENCES

1. Carter, D. L., W. W. Hunter, C. V. Zegeer, J. R. Stewart, and H. F. Huang. *Bicyclist Intersection Safety Index*. In *Transportation Research Record*, Vol. 2031. Washington, DC, 2007.
2. FHWA. *Manual on Uniform Traffic Control Devices*. Federal Highway Administration, U.S. Department of Transportation, Washington, DC, 2009.
3. FHWA. *The Pedestrian and Bicycle Crash Analysis Tool (PBCAT)*. Federal Highway Administration, U.S. Department of Transportation and the University of North Carolina Highway Research Center. <http://www.walkinginfo.org/facts/pbcats/index.cfm>
4. FHWA. *Pedestrian and Bicyclist Intersection Safety Indices*. Federal Highway Administration, U.S. Department of Transportation and the University of North Carolina Highway Research Center. <http://www.walkinginfo.org/library/details.cfm?id=2802>
5. Harkey, D. L., J. Mekemson, M. C. Chen, and K. Krull. *Pedestrian and Bicycle Crash Analysis Tool*. FHWA-RD-99-192. Federal Highway Administration, U.S. Department of Transportation, Washington, DC, 1999.
6. Harkey, D. L., S. Tsai, L. Thomas, and W. W. Hunter. *Pedestrian and Bicycle Crash Analysis Tool (PBCAT): Version 2.0 Application Manual*. FHWAHRT-06-089. Federal Highway Administration, U.S. Department of Transportation, Washington, DC, 2006.
7. ITE. *ITE Trip Generation Manual*, Eighth Ed. Institute of Transportation Engineers, Washington, DC, 2008.
8. ITE. *National Bicycle and Pedestrian Documentation Project*. Institute of Transportation Engineers, Washington, DC. <http://bikepeddocumentation.org>

Chapter 2: Bicycle Planning

9. Landis, B. *Real-Time Human Perceptions: Toward a Bicycle Level of Service*. In *Transportation Research Record 1578*. TRB. National Research Council, Washington, DC, 1997.
10. Stutts, J. C. and W. W. Hunter. *Injuries to Pedestrians and Bicyclists: An Analysis Based on Hospital Emergency Department Data*. FHWA-RD-99-078. Federal Highway Administration, U.S. Department of Transportation, Washington, DC, 1997.
11. TRB. *Highway Capacity Manual*. Transportation Research Board, Washington, DC, 2010.
12. TRB. *Synthesis 62: Integration of Bicycles and Transit: A Synthesis of Transit Practice*. Transportation Research Board, Transit Cooperative Research Program, TRB, Washington, DC, 2005.
13. University of North Carolina Highway Research Center. *Benefit–Cost Analysis of Bicycle Facilities*. <http://www.bicyclinginfo.org/bikecost>

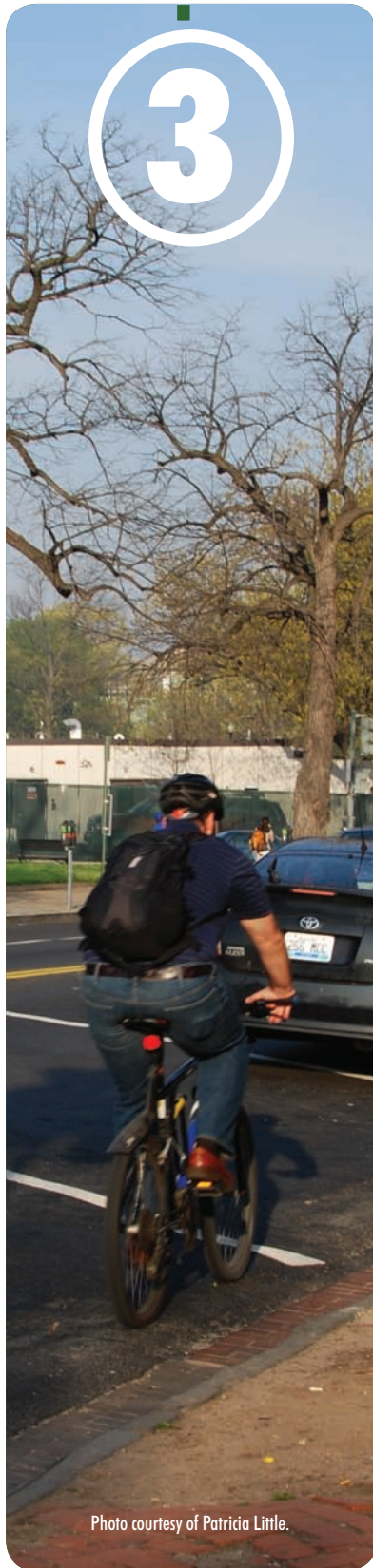

Photo courtesy of Patricia Little.

Bicycle Operation and Safety

3.1 INTRODUCTION

The purpose of this chapter is to provide the designer with a basic understanding of how bicyclists operate and how their vehicle influences that operation. Knowledge of these elements is essential in order to design appropriately for this mode. Due to the bicycle operator's physical exposure and the unique characteristics of their vehicle, bicyclists are susceptible to severe injury in even minor incidents. Understanding bicyclists' operating characteristics is therefore essential to design facilities that minimize the likelihood of injury. This chapter covers the following topics:

- Design Vehicle
- Traffic Principles for Bicyclists
- Causes of Bicycle Crashes

3.2 DESIGN VEHICLE

The physical dimensions and operating characteristics of bicyclists vary considerably. Some of this variation is due to differences in types and quality of bicycles, whereas other variations are due to differing abilities of bicyclists. For bikeways that are shared with other transportation modes such as shared use paths, the bicycle may not always be the critical design vehicle for every element of design. For example, most intersections between roads and pathways should be designed for pedestrian crossing speeds as they are the slowest user.

As with motor vehicles, there are multiple types of design bicyclists. Many of the design dimensions for bikeways presented in this guide are based on critical dimensions or characteristics of different types of bicyclists. For example, recumbent and hand bicyclists are the critical user for eye height; however, a bicycle with a trailer might be the critical user when designing a median refuge island at a shared use path-roadway intersection.

This guide therefore presents bikeway design dimensions that accommodate a range of bicyclists and other non-motorized users, as appropriate. Critical physical dimensions for upright adult bicyclists are shown in Figure 3-1. The minimum operating width of 4 ft (1.2 m), sufficient to accommodate forward movement by most bicyclists, is greater than the physical width momentarily occupied by a rider because of natural side-to-side movement that varies with speed, wind, and bicyclist proficiency. Additional operating width may be needed in some situations, such as on steep grades, and the figure does not include shy distances from parallel objects such as railings, tunnel walls, curbs, or parked cars. In some situations where speed differentials between bicyclists and other road users are relatively small, bicyclists may accept smaller shy distances. However this should not be used to justify designs that are narrower than recommended minimums. The operating height of 8.3 ft (2.5 m) can accommodate an adult bicyclist standing upright on the pedals. Other typical dimensions are shown in Figure 3-1 (4).

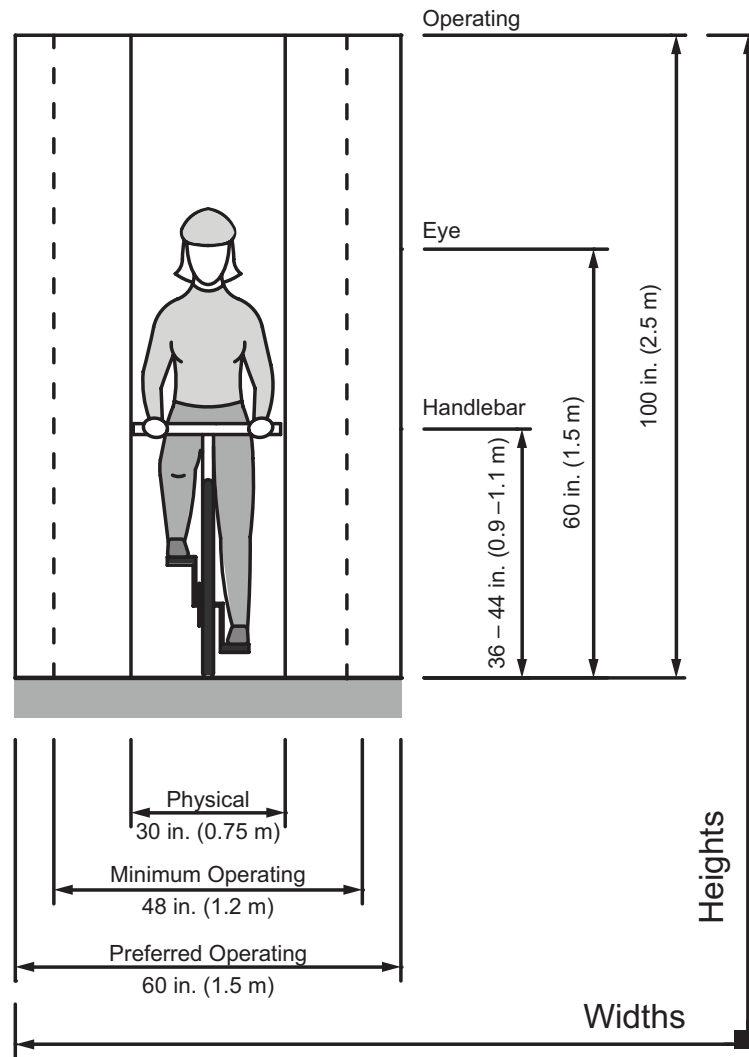

Figure 3-1. Bicyclist Operating Space

Chapter 3: Bicycle Operation and Safety

Figure 3-2 contains dimensions for several different types of bicycles including a typical bicycle, recumbent bicycle, tandem bicycle, and a bicycle with a child trailer (4). Table 3-1 lists various key dimensions for typical upright adult bicyclists and typical bicycle configurations, including upright, recumbent, and tandem bicycles; bicycles pulling a child trailer; and inline skaters. Unless otherwise noted, values associated with the 85th percentile of distribution are used to provide a conservative estimate that encompasses most bicyclists (1), (4), (11).

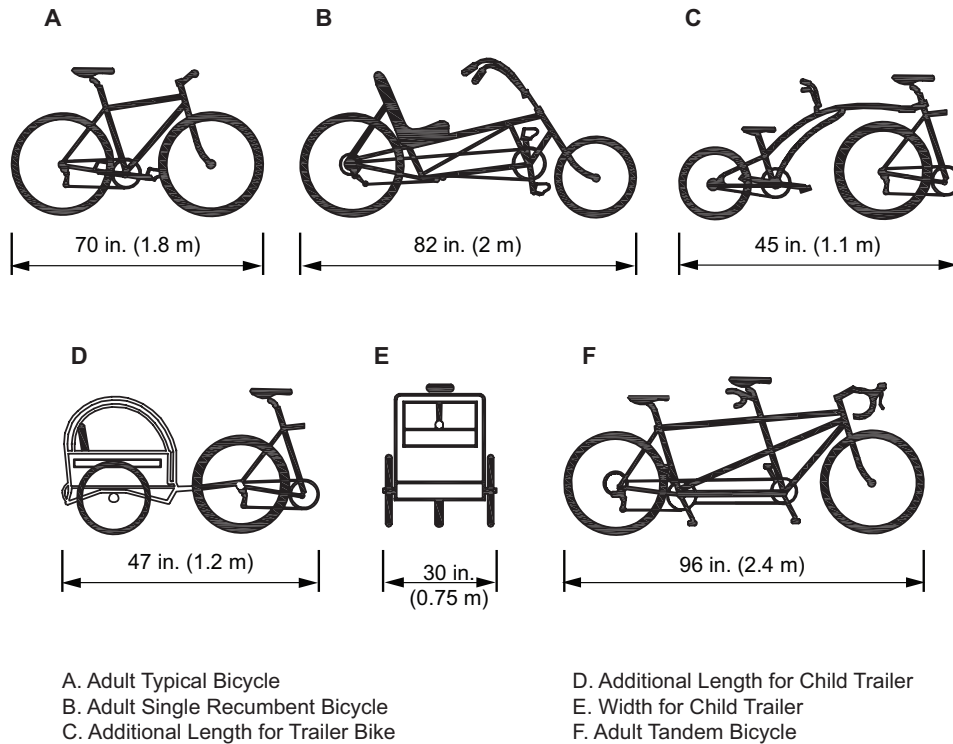

Figure 3-2. Typical Bicycle Dimensions

Table 3-1. Key Dimensions

User Type	Feature	Dimension	
		U.S. Customary	Metric
Typical upright adult bicyclist	Physical width (95th percentile)	30 in.	0.75 m
	Physical length	70 in.	1.8 m
	Physical height of handlebars (typical dimension)	44 in.	1.1 m
	Eye height	60 in.	1.5 m
	Center of gravity (approximate)	33–44 in.	0.8–10 m
	Operating width (minimum)	48 in.	1.2 m
	Operating width (preferred)	60 in.	1.5 m
	Operating height (minimum)	100 in.	2.5 m
	Operating height (preferred)	120 in.	3.0 m

Table 3-1. Key Dimensions (continued)

User Type	Feature	Dimension	
		U.S. Customary	Metric
Recumbent bicyclist	Physical length	82 in.	2.2 m
	Eye height	46 in.	1.2 m
Tandem bicyclist	Physical length (typical dimension)	96 in.	2.4 m
Bicyclist with child trailer	Physical width	30 in.	0.75 m
	Physical length	117 in.	3.0 m
Hand bicyclist	Eye height	34 in.	0.9 m
Inline skater	Sweep width	60 in.	1.5 m

As with bicycle dimensions, bicyclist performance can vary considerably based upon operator ability and vehicle design. Table 3-2 lists various performance criteria for typical upright adult bicyclists as well as key performance criteria for other types of bicyclists (1), (4), (11).

Bicyclist speeds vary based on age and ability and are a function of many factors, including bicyclist skill, bicyclist physical and cognitive abilities, bicycle design, traffic, lighting, wind conditions, transportation facility design, and terrain. Adults typically ride at 8–15 mph (13–24 km/h) on level terrain, while children ride more slowly. Experienced, physically fit riders can ride up to 30 mph (50 km/h); very fit riders can ride at speeds in excess of 30 mph (50 km/h) but will typically only ride at such speeds on roads.

Table 3-2. Key Performance Criteria

Bicyclist Type	Feature	Value	
		U.S. Customary	Metric
Typical upright adult bicyclist	Speed, paved level terrain	8–15 mph	13–24 km/h
	Speed, downhill	20–30 plus mph	32–50 plus km/h
	Speed, uphill	5–12 mph	8–19 km/h
	Perception reaction time	1.0–2.5s	1.0–2.5s
	Acceleration rate	1.5–5.0 ft/s ²	0.5–1.5 m/s ²
	Coefficient of friction for braking, dry level pavement	0.32	0.32
	Deceleration rate (dry level pavement)	0.16 ft/s ²	4.8 m/s ²
Recumbent bicyclist	Deceleration rate for wet conditions (50–80% reduction in efficiency)	8.0–10.0 ft/s ²	2.4–3.0 m/s ²
	Speed, level terrain	11–18 mph	18–29 km/h
	Acceleration rate	3.0–6.0 ft/s ²	1.0–1.8 m/s ²
	Deceleration rate	10.0–13.0 ft/s ²	3.0–4.0 m/s ²

Note: The speeds reported are for bicyclists on shared use paths. Experience suggests that maximum speeds on roadways can be considerably higher.

3.3 TRAFFIC PRINCIPLES FOR BICYCLISTS

This section describes the basic principles of operating a bicycle in traffic, including bicyclists' positioning on the road in a variety of different situations. A thorough understanding of these principles is needed to plan and design bikeways and roadways open to bicycling, particularly in challenging design contexts.

Because some states' laws differ on the specifics of legal bicycle operation, this section will address basic principles that are fairly universal regardless of legal statute. Local traffic culture and physical design may influence bicycle operating patterns more than the details of state traffic codes, which are often not well known even to licensed motorists. Bicyclists tend to operate similarly in comparable traffic conditions, regardless of where they are riding.

State traffic codes in the United States either explicitly define the bicycle as a vehicle or give the operator of a bicycle the rights and duties of an operator of a vehicle, with exceptions (e.g., bicycles may be ridden on sidewalks in some circumstances). The fact remains, however, that the bicycle has different physical dimensions and performance characteristics than a motor vehicle. A bicyclist is also more vulnerable in the event of a crash than a motorist. The basic principles of bicycle operation in traffic include the following:

Bicyclists on a Two-Way Road Ordinarily Ride on the Right Side of the Roadway

In the United States, vehicle operators (including bicyclists) on a two-way road travel on the right side relative to their respective direction of travel. With only a few exceptions (such as when bike lanes are provided in both directions on an otherwise one-way street), bicyclists operating in the street ride with the flow of other traffic. Bicyclists may sometimes ride on the left side of a one-way street, typically if a bike lane exists on the left side, if there are markedly fewer conflicts on the left (e.g., no on-street parking and few turning conflicts), or if there is a major destination accessed from the left side.

Bicyclists Obey Stop and Yield Signs, and Observe Yielding Rules

Similarly to other vehicular traffic, a bicyclist on a minor road (including driveways and alleys, depending upon individual state laws) must yield to traffic on major roads. In this case, yielding means proceeding only when it is safe to do so while obeying all traffic control devices.

Bicyclists Yield When Changing Lanes

Bicyclists, like motorists, who want to move laterally on the roadway must yield to traffic in their new line of travel. In this situation, yielding means moving into the new line of travel after ascertaining that the move can be made safely, and then signaling the intended movement.

Bicyclists Overtake Other Vehicles On the Left

A bicyclist overtaking another vehicle proceeding in the same direction must pass on the left of the vehicle being overtaken. This same basic operating principle applies to shared use paths, when bicyclists overtake pedestrians or other slower users. For bicyclists on roadways, there are several exceptions to this rule: (1) a bicyclist may pass on the right when in a bike lane; (2) a bicyclist may pass on the right when the vehicle to be overtaken is turning left or indicating a left turn; and (3) some states allow bicyclists to pass on the right when it is safe to do so.

Bicyclists' Lateral Position on the Roadway Is Determined by Speed and Usable Width

Bicyclists ride as far right as practical, which on a typical roadway means that the bicyclist rides in (or near) the right tire track. A bicyclist traveling at the same speed as other traffic, or in a travel lane too narrow for a motor vehicle to safely pass without encroaching into the adjacent lane, travels in the center of the lane (often referred to as “taking the lane”). The primary reason for taking the lane is to encourage overtaking traffic to make a full lane change instead of squeezing past the bicyclist in the same lane. The Uniform Vehicle Code and most State codes support bicyclists' right to take the lane, if necessary. Most vehicle codes also allow exceptions to the rightmost position on the road requirement for reasons such as avoiding hazards, passing other bicyclists and preparing for and making left turns. Slower bicyclists travel to the right of faster bicyclists (and other vehicles). Like other vehicles, emergency stops made by bicyclists must occur at the rightmost position on the road.

Bicyclists Approach Intersections in the Rightmost Lane That Provides for Their Movement

Bicyclists approaching intersections typically position themselves in the rightmost lane that provides for their desired movement. For example, bicyclists traveling straight through at an intersection should not position themselves in or to the right of a dedicated right-turn lane, but rather in the right-most through-travel lane. Another exception occurs when a bicyclist makes a pedestrian-style left turn. This is explained below.

Bicyclists Have Several Options for Turning Left at an Intersection

Bicyclists turning left at an intersection commonly perform this maneuver in the following ways depending upon skill level and traffic volumes: (1) A vehicular-style left turn in which the bicyclist turns left from the left side of the right half of the roadway, or from the right-most left turn lane, and proceeds directly into the bike lane; (2) the same vehicular-style left turn as described previously but the bicyclist proceeds into the left-most lane of the departing leg, then into the right-most lane, and finally into the bicycle lane; or (3) a pedestrian-style left turn in which the bicyclist travels in the right-most through lane across the intersection, stops at the far crosswalk, makes a 90-degree turn, and then with the proper signal indication, either walks the bicycle in the crosswalk or proceeds as if coming from the right (see Figure 3-3).

3.4 CAUSES OF BICYCLE CRASHES

By understanding the underlying causes of common bicyclist crashes, designers can more thoroughly comprehend the rationale behind many of the design principles set forth in this guide. This section discusses common types of crashes that bicyclists experience, and how crashes relate to facility design.

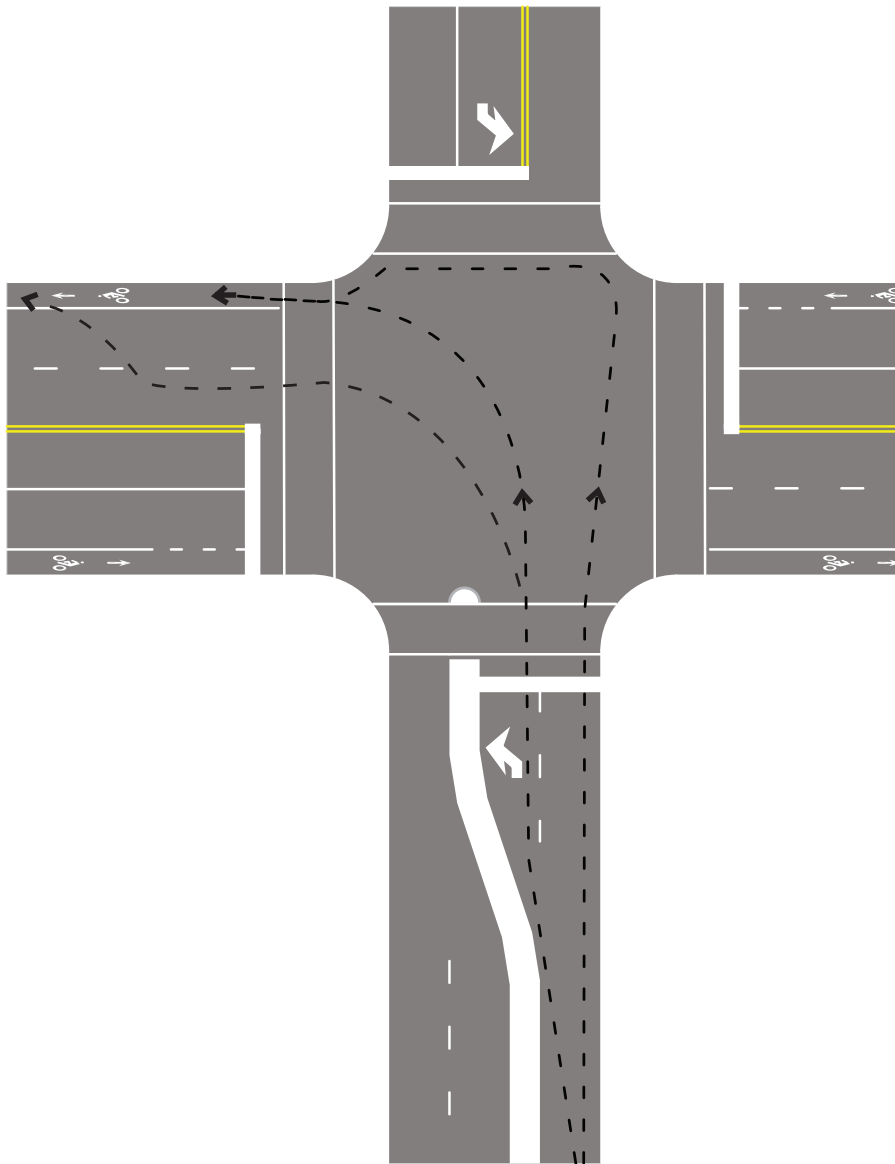

Figure 3-3. Common Maneuvers for Bicyclists Turning Left at an Intersection

3.4.1 Bicyclist Crash Studies

Numerous studies of bicycle crashes in the United States conducted over the past 40 years have produced very consistent results. This section summarizes common types of crashes and the factors that contribute to those crashes. Most information on bicyclist injury crashes comes from crashes with motor vehicles occurring in the public right-of-way, because reporting these crashes is mandatory in most states. Bicyclist-motor vehicle crashes that occur in non-roadway locations (paths, parking lots, and driveways), as well as injury crashes that do not involve a motor vehicle, are usually not included in State DOT crash databases. Studies that examined hospital records have demonstrated that the majority (70–90 percent) of bicyclist crashes that are serious enough to warrant a trip to the emergency room are not the result of a collision with a motor vehicle. Most result from falls, crashes with fixed objects, and collisions with other bicyclists (10).

3.4.2 Overall Findings

An examination of bicyclist-motor vehicle crashes in the aggregate yields less useful information than subdividing the results into the following broad categories: urban vs. rural, young vs. adult bicyclists, bicyclist vs. driver error, nighttime vs. daytime, and riding on the sidewalk vs. the roadway.

Urban vs. Rural

In urban areas, the majority of crashes occur at intersections and driveways (3). These include bicyclists hit by motorists turning into and out of driveways and intersecting roadways, as well as bicyclists exiting driveways onto roadways. Left- and right-turning motorists failing to yield to an oncoming bicyclist is a very common urban crash type. Hitting an open car door is estimated to represent between 3 percent and 6 percent of urban crashes; this percentage can be higher in cities with a high amount of on-street parking, lower in suburban areas with no on-street parking (2), (7), (9). Overtaking or being struck from behind represents a small portion of crashes in urban areas, but a larger portion of crashes on rural roads. Overtaking crashes in urban areas often occur at night and are usually associated with poor lighting conditions. Overtaking crashes in rural areas are often associated with distracted drivers, or drivers driving too fast in areas with poor visibility (around curves or over the crest of a hill). Serious and fatal crashes are more likely to occur in rural areas (3), (8).

Youth vs. Adult Bicyclists

Compared to their representation in the overall population, bicyclists under the age of 15 (particularly ages 10–14) are overrepresented in crashes with motor vehicles, while adults ages 25–44 and seniors (age 65+) are underrepresented. However, bicyclists older than age 44 are overrepresented with regard to serious and fatal injury (3).

Bicyclist vs. Driver Error

Bicyclists were judged to be solely at fault in about half of crashes with motor vehicles. Failure to yield, riding against traffic, and stop sign violations are the most common bicyclist contributing factors. Failure to yield is the most common contributing factor in crashes where motorists were at fault. The likelihood of a bicyclist being responsible for a crash is greater for young bicyclists; the likelihood of a motor vehicle driver being responsible is greater for crashes involving adult bicyclists.

Nighttime vs. Daytime

The relatively high incidence of crashes that occur at night and dusk indicate that poor roadway lighting and a lack of required lighting and/or reflectorization on the bicycle appear to be contributing factors (5), (6). The lack of supporting data on exposure makes it difficult to confirm this hypothesis, but bicyclists appear to be disproportionately struck at night, especially struck from behind; bicycles not being equipped with the required lighting and/or reflective equipment appears to be a contributing factor.

Riding on the Sidewalk vs. the Roadway

In general it is undesirable for bicyclists to ride on sidewalks. There is significantly higher incidence of bicyclist-motor vehicle crashes with bicyclists riding on the sidewalk than with bicyclists operating in the roadway. The issue with sidewalk bicycle riding is compounded by bicyclists riding against the flow of adjacent traffic, as motorists crossing or turning left or right at driveways and intersections usually do not look for bicyclists traveling on the sidewalk. Bicyclists sharing the sidewalk with pedestrians is also a concern because sidewalks are typically designed for pedestrian speeds and maneuverability and are not appropriate for higher speed bicycle use. Conflicts are common between pedestrians traveling at low speeds (e.g., exiting stores, parked cars, etc.) and bicyclists, as are conflicts of bicyclists with fixed objects (e.g., parking meters, utility poles, sign posts, bus benches, trees, fire hydrants, mail boxes, etc.). Walkers, joggers, skateboarders, and inline skaters can, and often do, change their speed and direction almost instantaneously, leaving bicyclists insufficient reaction time to avoid collisions. Similarly, pedestrians often have difficulty predicting the direction an oncoming bicyclist will take. Sight distance is often impaired by buildings, walls, property fences, and shrubs along sidewalks, especially at driveways. In addition, bicyclists and pedestrians often prefer to ride or walk side-by-side when traveling in pairs. Sidewalks are typically too narrow to enable this to occur without serious conflicts between users (3).

It is important to recognize that the development of extremely wide sidewalks does not necessarily add to the safety of sidewalk bicycle travel. Wide sidewalks might encourage higher speed bicycle use and can increase potential for conflicts with motor vehicles at intersections, as well as with pedestrians and fixed objects.

In certain instances, however, it is reasonable to provide bicyclists with the option to ride on sidewalks. For example, the Safe Routes to School program encourages young children to ride on sidewalks; and at roundabouts, if provided the option, bicyclists may choose to navigate the roundabout using a sidewalk. The characteristics of the roadway and the skill levels of the bicyclists should be considered before providing the option or encouraging bicyclists to ride on the sidewalk.

3.4.3 Contributing Causes of Bicyclist-Motor Vehicle Crashes and Recommended Countermeasures

An understanding of the contributing causes of bicyclist-motor vehicle crashes can help decision makers choose appropriate engineering/design treatments, and implement meaningful education and enforcement programs. The following list of common behaviors includes recommended strategies to reduce the incidence of crashes due to these behaviors. The recommended engineering/design treatments are explained in further detail later in this guide.

Wrong-Way Riding

Riding in the direction that faces oncoming traffic puts bicyclists in a position where motorists (and other bicyclists) do not expect them, and for this reason is prohibited on the roadway. The attention of motorists who are entering the roadway is primarily directed to the left (to determine a suitable gap), and they may fail to notice bicyclists approaching from their right. Also, drivers turning from the roadway may not be looking for bicyclists approaching from behind. There are also concerns with sidepath intersections, as all path traffic in the contraflow direction will be approaching in this manner. Remedies for this behavior include education and enforcement, as well as engineering treatments that reinforce the correct direction of roadway travel. Providing bike lanes in both directions of travel may reduce the incidence of wrong-way riding, as well as the use of the bicycle “Wrong Way Sign” and “Ride with Traffic” plaque (R5-1b and R9-3cP) and shared-lane markings.

Sidewalk Riding

At driveways and intersections, motorists often drive onto the sidewalk area or crosswalk to get a better view of traffic and may not look for bicyclists approaching on the sidewalk or bicyclists riding against the direction of roadway traffic. Motorists turning right into a driveway or intersection may not see bicyclists on sidewalks approaching on the right from behind them. The primary remedies for this behavior are education and enforcement in locations where riding on sidewalks is illegal. The most appropriate engineering measure to address this issue is to design the roadway to accommodate bicyclists, with techniques such as bike lanes on busy streets, and/or traffic calming to reduce motor vehicle speeds and/or volumes.

Other Crashes at Driveways

Crashes also commonly occur at driveways in two other scenarios: 1) driver enters roadway from a driveway and strikes a bicyclist riding in the street; and 2) driver turns off roadway into a driveway and strikes a bicyclist on the sidewalk area (3). Though the issue is motorist behavior, access control to limit the number of driveways on bicycling corridors and improving corner sight distance at driveways may reduce these types of crashes.

Motorist Striking Bicyclist with Vehicle Door (“Dooring”)

This type of crash occurs when a driver or passenger of a standing or parked motor vehicle opens a door into traffic without making sure it is safe to do so and strikes a bicyclist traveling near the parked vehicle. Remedies include educating motorists (training them to look for bicyclists before opening their door) and bicyclists (training them not to ride too close to parked cars and to be on the lookout for drivers opening their door, although the latter has become more difficult due to tinted windows and taller vehicle design and such behavior diverts the bicyclist’s attention from the road). Design treatments can help to reduce the likelihood of this type of crash. If a bike lane is marked next to a parking lane, using a second stripe between the bike lane and parking lane helps place bicyclists further from parked cars. Some communities have used shared lane markings in narrow lanes to encourage bicyclists to track over the symbol and away from parked cars.

Bicyclists Failing to Yield at Controlled Intersections

The key behavior needed to avoid collisions at intersections is yielding. Attempts to enforce “full stop” compliance at stop-controlled junctions where most riders find they can safely yield without making a full stop are unlikely to be successful, given bicyclists’ strong counterincentive to minimize the amount of energy needed to regain momentum after stopping or slowing. Signing bike routes on local streets with many stop signs gives a conflicting message to riders: the streets

may appear inviting, but a requirement to stop at every block is discouraging. Developing bicycle boulevards (where through bicycle movement with few stops is facilitated by design) is a better solution. Timing signals to better accommodate typical urban bicycling speeds may be helpful on arterial intersections.

Motorists Failing to Yield at Intersections

The most common crash type in this category involves the failure of a left-turning motorist to yield to an oncoming bicyclist; the second most common involves a right-turning motorist who strikes a through bicyclist (often referred to as a “right-hook” crash) (3). Measures that increase bicyclist conspicuity such as lights, reflectors, and/or high-visibility clothing can be helpful, as can geometric modifications that limit vehicle turning speeds (e.g., reduced curb radii). A bike lane provided along the left of a dedicated right-turn lane can also help reduce the incidence of such crashes. When there is insufficient width for a bike lane, shared lane markings can also be used to encourage proper positioning. Protected left-turn signal phases, where warranted, may help reduce left-turn crashes.

Bicyclists Struck from Behind

While this crash type represents a small portion of urban crashes, it represents a significant portion of rural crashes, especially fatalities (3). Adding paved shoulders to narrow rural roads with high traffic volumes is an effective countermeasure.

Night-Time Bicycle Riding

About a third of bicyclist crashes occur between the hours of 5:00 p.m. and 9:00 p.m.; about a third of bicycling fatalities occur between 6:00 p.m. and midnight. Educating bicyclists about the importance of using lights and reflectors and enforcing bicycle equipment requirements can be effective countermeasures since all states require use of lighting equipment after sunset (headlights in front, rear reflectors usually, and tail lamps as well in some states).

Bicycle Crashes Involving Children

Children under the age of 16 tend to be over-represented in crashes where the bicyclist was at fault. Crash types where this group is overrepresented include disobeying stop signs, riding out at driveways, turning, or merging in front of traffic without yielding, and non-roadway crashes (parking lots and driveways) (3). Some of these are behavioral issues related to lack of experience and speed recognition issues, where bicyclist education and police enforcement (primarily warnings) could help, coupled with motorist education regarding awareness of children’s limitations. Creating a bicycle-friendly roadway environment where motorists drive more slowly will also help reduce the number and severity of crashes involving children.

REFERENCES

1. Florida Department of Transportation. *Florida Bicycle Facilities Planning and Design Handbook*. Florida Department of Transportation, Tallahassee, FL, 2000.
2. Goodno, M. *Bicycle Collisions in the District of Columbia*. District Department of Transportation, Washington, DC, 2004.
3. Hunter, W. W., J. C. Stutts, W. E. Pein, and C. L. Cox. *Pedestrian and Bicycle Crash Types of the Early 1990’s*. FHWA-RD-95-163. Federal Highway Administration, Washington, DC, 1996.

4. Landis, B. W, T. A. Petrisch, and H. F. Huang. *Characteristics of Emerging Road and Trail Users and Their Safety*. FHWA-HRT-04-104. Federal Highway Administration, Washington, DC, 2004.
5. National Highway Traffic Safety Administration. *Traffic Safety Facts 2003*. National Highway Traffic Safety Administration, (n.d.). DOT HS 809 775. Washington, DC, 2003.
6. National Highway Traffic Safety Administration. *Traffic Safety Facts 2005*. National Highway Traffic Safety Administration, (n.d.). DOT HS 810 631. Washington, DC, 2005.
7. New York City Departments of Health and Mental Hygiene, Parks and Recreation, Transportation, and the New York City Police Department. *Bicyclist Fatalities and Serious Injuries in New York City 1996–2005*. New York, NY, s.n., n.d.
8. North Carolina Department of Transportation. North Carolina Bicycle Crash Data. Pedestrian and Bicycle Information Center. <http://www.pedbikeinfo.org/pbcat/index.cfm>
9. Plotkin, W. and A. Komornick. *Bicycle-Motor Vehicle Accidents in the Boston Metropolitan Region*. Metropolitan Area Planning Council, Boston, MA, 1984.
10. Stutts, J. C. and W. W. Hunter. *Injuries to Pedestrians and Bicyclists: An Analysis Based on Hospital Emergency Department Data*. FHWA-RD-99-078. Federal Highway Administration Washington, DC, 1997.
11. Vermont Agency of Transportation. *Vermont Pedestrian and Bicycle Facility Planning and Design Manual*. Vermont Agency of Transportation, Montpelier, VT, 2002.



Design of On-Road Facilities

4.1 INTRODUCTION

This chapter provides an overview of designs that facilitate safe and convenient travel for bicyclists on roadways. Bicyclists have similar access and mobility needs as other users of the transportation system and may use the street system as their primary means of access to jobs, services, and recreational activities. As the previous chapter discusses, bicycles and bicyclists have many unique features and characteristics that should be understood in order to design successfully for this mode.

Unlike the operator of a motor vehicle, whose primary responsibility is navigation and operation, the bicyclist also provides the power to propel the vehicle and maintains the balance necessary to keep the vehicle upright. When traffic is not congested, bicyclists usually travel more slowly than other vehicular operators on the roadway. The speed at which bicyclists can travel is limited by the relative physical strength and fitness of the operator, the terrain and geometry of the roadway, and the gearing and condition of the individual bike. Two tandem wheels make the bicycle inherently more maneuverable than an automobile, but a bicyclist is significantly more vulnerable to injury in the event of a crash. While motor vehicle operators must reach a certain age before being eligible for a license to operate on the public way, bicyclists are subject to no age limitations. All of these factors make proper bicycle facility design critical.

The guidance provided in this chapter is based on established practice supported by relevant research where available. The treatments described reflect typical situations; local conditions may vary and engineering judgment should be applied.

4.2 ELEMENTS OF DESIGN

To some extent, basic geometric design guidelines for motor vehicles will result in a facility that accommodates on-street bicyclists. If properly designed for motor vehicles, roadway design elements such as stopping sight distance, horizontal and vertical alignment, grades, and cross slopes will meet or exceed the minimum design

standards applicable to bicyclists. For example, with the exception of recumbent bicyclists, most adult bicyclists have an eye height that is higher than the standard motorist eye height which is used to determine stopping sight distance.

Surface condition and pavement smoothness are important to bicyclist control and comfort. Gravel roads, loose material, cracks, bumps, and potholes on a paved roadway create an impediment for bicyclists and will have an impact on which routes a bicyclist will choose. Chip-sealed surfaces can pose particular difficulties for bicycles. Existing and anticipated bicycle use should be reviewed as part of the decision to use chip-sealed surfaces. Where practical, avoiding chip-sealed surfaces will encourage bicycle use. The impacts of chip seals on bicyclists can be reduced by using a fine mix and covering with a fog or slurry seal.

4.3 SHARED LANES

Bicycles may be operated on all roadways except where prohibited by statute or regulation. In most instances, bicyclists and motor vehicles share the same travel lanes. Shared lanes exist everywhere; on local neighborhood streets, on city streets, and on urban, suburban, and rural highways. There are no bicycle-specific designs or dimensions for shared lanes or roadways, but various design features can make shared lanes more compatible with bicycling, such as good pavement quality; adequate sight distances; roadway designs that encourage lower speeds; and bicycle-compatible drainage grates, bridge expansion joints, and railroad crossings. Appropriate signal timing and detector systems that respond to bicycles also make shared lanes more compatible with bicycling. If such features are not present, improvements or retrofits should be implemented. Other sections of this chapter address bicycle-compatible design features in more detail.

Generally speaking, roadways that carry very low to low volumes of traffic, and may also have traffic typically operating at low speeds, may be suitable as shared lanes in their present condition. Rural roadways with good sight distance that carry low volumes of traffic and operate at speeds of 55 mph (89 km/h) or less may also be suitable as shared lanes in their present condition. Such roads often provide an enjoyable and comfortable bicycling experience with no need for bike lanes or any other special accommodations to be compatible with bicycling. If they provide a route for continuous travel, these roads can also be used as an alternative to busier highways or streets. For example, a narrow and curving rural road with low traffic volumes can be a very suitable and popular bicycling route, and may be preferable for some bicyclists as compared to a high-speed, high-volume highway with good geometrics and shoulders—as long as the road serves as a convenient through route to the desired destinations. Outside urban areas, these types of roads may comprise a high percentage of popular or designated bicycle routes, and may be appropriate for designation as a local, state-level, or U.S. Bicycle Route.

Various geometric and operational factors affect the comfort level of bicyclists in shared lanes. Models have been developed that quantify how various geometric and operational factors affect bicyclists. The Bicycle LOS model includes factors such as roadway lane width, lane use, traffic speed and volume, on-street parking, and surface condition in order to grade a roadway's relative comfort for bicyclists. This model can be used to determine to what extent shared lanes will adequately accommodate bicyclists given roadway conditions that exist today, or that are forecasted in the future. See Chapter 2 for a more detailed description of the use and application of the Bicycle LOS model.

4.3.1 Shared Lanes on Major Roadways (Wide Curb/Outside Lanes)

Lane widths of 13 ft (4.0 m) or less make it likely that most motor vehicles will encroach at least part way into the next lane to pass a bicyclist with an adequate and comfortable clearance (usually 3 ft [0.9 m] or more depending on the speed of the passing vehicle). Lane widths that are 14 ft (4.3 m) or greater allow motorists to pass bicyclists without encroaching into the adjacent lane. The usable lane width is normally measured from the center of the edge line to the center of the traffic lane line, or from the longitudinal joint of the gutter pan to the center of the lane line. The gutter should not be included in the measurement as usable width, as bicyclists will typically ride well to the left of the joint.

On sections of roadway where bicyclists may need more maneuvering space, the outside lane may be marked at 15 ft (4.6 m) wide. This width may be appropriate on sections with steep grades or on sections where drainage grates, raised delineators, or on-street parking effectively reduces the usable width. However, lane widths in extremely congested areas that continuously exceed 16 ft (4.9 m) may encourage the undesirable operation of two motor vehicles side by side. The provision of wide outside lanes should also be weighed against the likelihood that motorists will travel faster in them and that heavy vehicles (where present) will prefer them to inside lanes, resulting in decreased level of service for bicyclists and pedestrians. When sufficient width is available to provide bike lanes or paved shoulders, they are the preferred facilities on major roadways. Roadways with shared lanes narrower than 14 ft (4.3 m) may still be designated for bicycles with bicycle guide signs and/or shared-lane markings, per the guidance in this chapter.

4.3.2 Signs for Shared Roadways

A “Share the Road” sign assembly (W11-1 + W16-1P) (see Figure 4-1) is intended to alert motorists that bicyclists may be encountered and that they should be mindful and respectful of bicyclists (3). However, the sign is not a substitute for appropriate geometric design measures that can improve the quality of service for bicyclists. The sign should not be used to address reported traffic operational issues, as the addition of this warning sign will not significantly improve bicycling conditions. The sign may be used under certain limited conditions, such as at the end of a bike lane, or where a shared use path ends and bicyclists must share a lane with other traffic. The sign may also be used in work zones, where bicyclists may need to share a narrower space than usual on a traveled way. This sign should not be used to indicate a bike route. A fluorescent yellow-green background can be used for this sign.

Another sign that may be used in shared lane conditions is the “BICYCLES MAY USE FULL LANE” sign (R4-11) (see Figure 4-2) (3). This sign may be used on roadways without bike lanes or usable shoulders where travel lanes are too narrow for bicyclists and motorists to operate side by side within a lane.



Figure 4-1. “Share the Road” Sign Assembly



Figure 4-2. Bicycles “May Use Full Lane” Sign

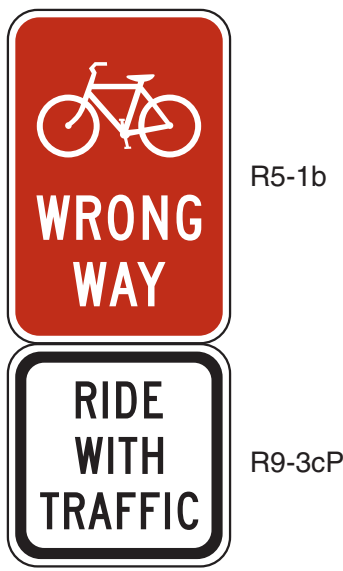

Figure 4-3. “Wrong Way—Ride with Traffic” Sign Assembly

For locations where wrong-way riding by bicyclists is frequently observed, the MUTCD (3) provides a bicycle “WRONG WAY SIGN” and “RIDE WITH TRAFFIC” plaque (R5-1b and R9-3cP) that can be mounted back-to-back with other roadway signs (such as parking signs) to reduce sign clutter and minimize visibility to other traffic (see Figure 4-3). This sign assembly can be used in shared lane situations, as well as on streets with bike lanes and paved shoulders.

4.4 MARKED SHARED LANES

In situations where it is desirable to provide a higher level of guidance to bicyclists and motorists, shared lanes may be marked with a pavement marking symbol (see Figure 4-4). The symbol, known as the shared-lane marking, is useful in locations where there is insufficient width to provide bike lanes. The marking also alerts road users to the lateral position bicyclists are likely to occupy within the traveled way, therefore encouraging safer passing practices (including changing lanes, where needed). Shared-lane markings may also be used to reduce the incidence of wrong-way bicycling.

Shared-lane markings may be applicable in the following scenarios:

- In a shared lane with adjacent on-street parallel parking, to assist bicyclists with lateral positioning that reduces the chance of a bicyclist impacting the open door of a parked vehicle.
- On wide outside lanes, to indicate more appropriate positioning away from the curb or the edge of the traveled way.
- On a section of roadway with shared lanes, to fill a gap between two sections of roadway that have bike lanes, or to fill a gap between a shared use path and a nearby destination, or other similar connections.
- On a section of roadway where the lanes are too narrow for a bicyclist and motorist to travel side-by-side in the lane.
- On a steep downgrade section of roadway where there is room for only one bike lane. In these situations, a bike lane should be used on the upgrade section due to the bicyclist’s slower operating speed moving uphill.
- It may be appropriate to use shared-lane markings, rather than a bike lane, on a steep downgrade section of roadway where bicycle speeds are high and parking is present, since bicyclists may choose not to use a bike lane when traveling at high speeds adjacent to parked vehicles.
- At multilane intersections where there is insufficient width to provide a bike lane, and conflicts make it desirable to indicate proper positioning.

- At transit stops, to provide visual cues to motorists and bicyclists on the correct path to follow.
- Shared-lane markings are not appropriate on paved shoulders or in bike lanes, and should not be used on roadways that have a speed limit above 35 mph (50 km/h). Shared-lane markings should be placed immediately after an intersection and spaced at intervals not greater than 250 ft (76 m) thereafter.
- Shared-lane markings should be marked on an alignment that represents a practical path of bicycle travel under typical conditions. For some streets, this may be the center of a shared travel lane. On a one-way street designated as a bicycle route, where the bicycle route makes a left turn, it may be appropriate to place shared-lane markings on both the outside right and left lanes of the street.

The following provides guidance from the MUTCD (3) on shared-lane marking placement (all values given are to the center of the marking):

- On streets with on-street parallel parking, shared-lane markings should be placed at least 11 ft (3.4 m) from the face of curb, or edge of the traveled way where there is no curb (see Figure 4-5).
- On streets without on-street parallel parking, shared-lane markings should be placed at least 4 ft (1.2 m) from the face of curb, or edge of the traveled way where there is no curb (see Figure 4-6).
- The shared-lane markings can be placed farther into the lane than the minimum distance shown above, where appropriate, such as where the lane is too narrow for side-by-side operation of a bicycle and a motor vehicle. The MUTCD (3) contains further guidance on shared-lane markings.

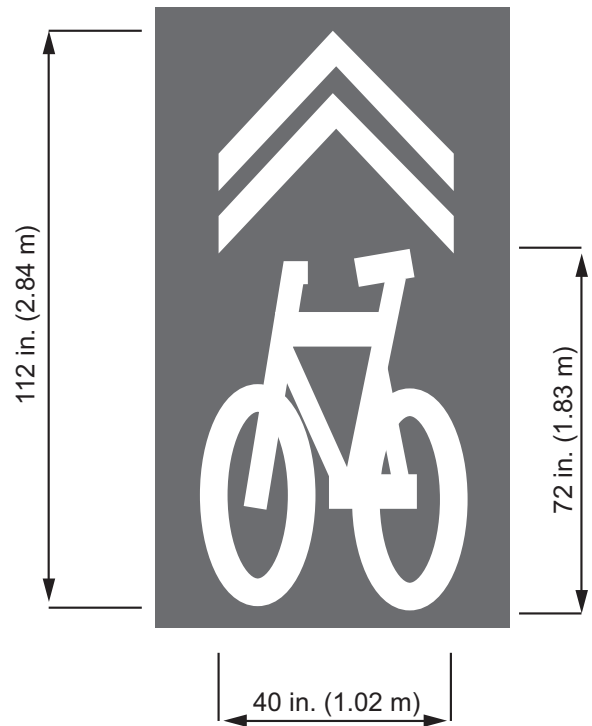

Figure 4-4. Shared-Lane Marking

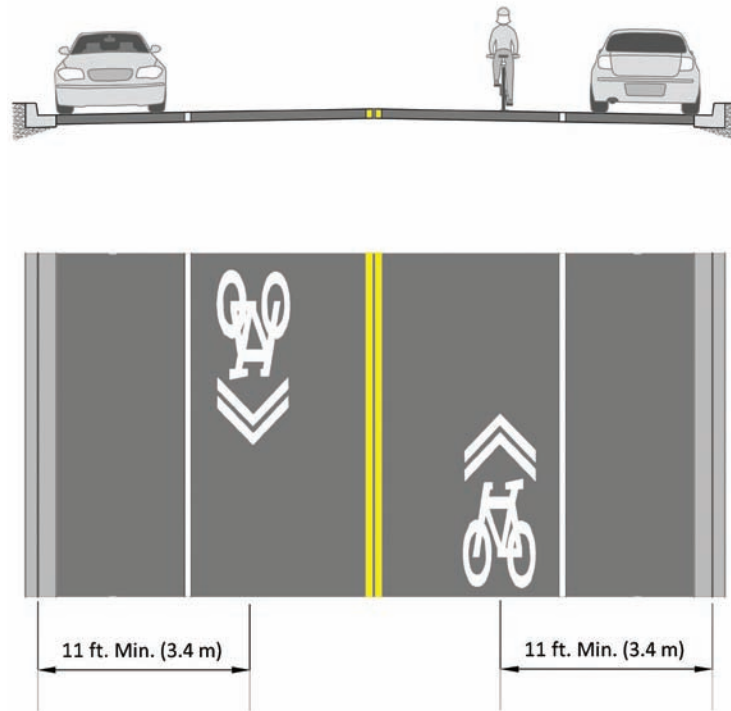

Figure 4-5. Typical Shared-Lane Marking Cross Section on Street with Parking

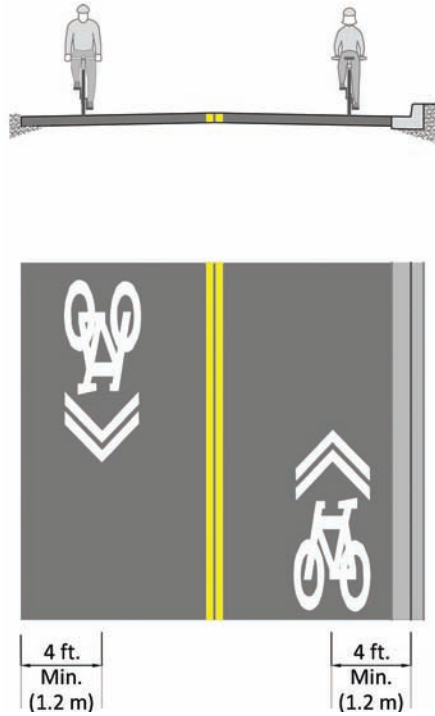

Figure 4-6. Typical Shared-Lane Marking Cross Section on Street with No On-Street Parking

4.5 PAVED SHOULDERS

Adding or improving paved shoulders can greatly improve bicyclist accommodation on roadways with higher speeds or traffic volumes, as well as benefit motorists (as described in AASHTO's *A Policy on Geometric Design of Highways and Streets (1)*). As described in Chapter 2, paved shoulders are most often used on rural roadways. Paved shoulders extend the service life of the road by reducing edge deterioration, and provide space for temporary storage of disabled vehicles.

It is important to understand the differences between paved shoulders and bike lanes, particularly when a decision needs to be made as to which facility is more appropriate for a given roadway. Bike lanes are travel lanes, whereas in many jurisdictions, paved shoulders are not (and can therefore be used for parking). Paved shoulders, if provided on intersection approaches, typically stay to the right of right-turn lanes at intersections, whereas bike lanes are placed on the left side of right-turn lanes because they are intended to serve through movements by bicyclists; through bicyclists should normally be to the left of right-turning motor vehicles. To avoid conflicts on roadways with paved shoulders that approach right-turn lanes, some jurisdictions introduce a bike lane only at the intersections, and then transition back to a paved shoulder. Such treatments are addressed in Section 4.8.

For any given roadway, the determination of the appropriate shoulder width should be based on the roadway's context and conditions in adjacent lanes. On uncurbed cross sections with no vertical obstructions immediately adjacent to the roadway, paved shoulders should be at least 4 ft (1.2 m) wide to accommodate bicycle travel. Shoulder width of at least 5 ft (1.5 m) is recommended from the face of a guardrail, curb, or other roadside barrier to provide additional operating width, as bicyclists generally shy away from a vertical face. It is desirable to increase the width of shoulders where higher bicycle usage is expected. Additional shoulder width is also desirable if motor vehicle speeds exceed 50 mph (80 km/h); if use by heavy trucks, buses, or recreational vehicles is considerable; or if static obstructions exist at the right side of the roadway. The Bicycle LOS model may be used to determine the appropriate shoulder width (see Chapter 2 on "Bicycle Planning").

It is preferable to provide paved shoulders on both sides of two-way roads. In constrained locations where pavement width is limited, it may be preferable to provide a wider shoulder on only one side of the roadway, rather than to provide a narrow shoulder on both sides. This may be beneficial in the following situations:

- On uphill roadway sections, a shoulder may be provided to give slow-moving bicyclists additional maneuvering space, thereby reducing conflicts with faster moving motor vehicle traffic.
- On roadway sections with vertical or horizontal curves that limit sight distance, it can be helpful to provide shoulders over the crest and on the downgrade of a vertical curve, and on the inside of a horizontal curve.

For information on retrofitting paved shoulders onto existing roadways, see Section 4.9. Where an unpaved driveway meets a roadway or pathway, it is advisable to pave some portion of the driveway approach to prevent loose gravel from spilling onto the travel way or shoulder. Paving at least 10 ft (3 m) on (low-volume) driveway connections, and 30 ft (9 m) or to the right-of-way line, whichever is less, on unpaved public road connections, can mitigate the worst effects of loose gravel. Where practical, the paved section of the approach to the highway should be sloped downward away from the highway to reduce the amount of loose material tracked into the shoulder.

Raised pavement markers (also known as pavement reflectors) can have a detrimental effect on bicycling when placed along a shoulder or bike lane line, as they can deflect a bicycle wheel, causing a loss of control. If pavement markers are used, consideration should be given to installing the markers on the travel lane side of the edge line, and the marker should have beveled or non-abrupt edges.

4.5.1 Shoulder Bypass Lanes

It is becoming a common design practice to incorporate bypass lanes at T-intersections of two-lane roadways, so as to facilitate the passing of motorists stopped to make left turns onto intersecting roads. Where this is done on a highway with paved shoulders, at least 4 ft (1.2 m) of shoulder pavement should be carried through the intersection along the outside of the bypass lane. This is especially critical on roadways with high volumes and operating speeds. An example of a preferred bypass lane treatment with a continuous paved shoulder usable by bicyclists is shown in Figure 4-7.

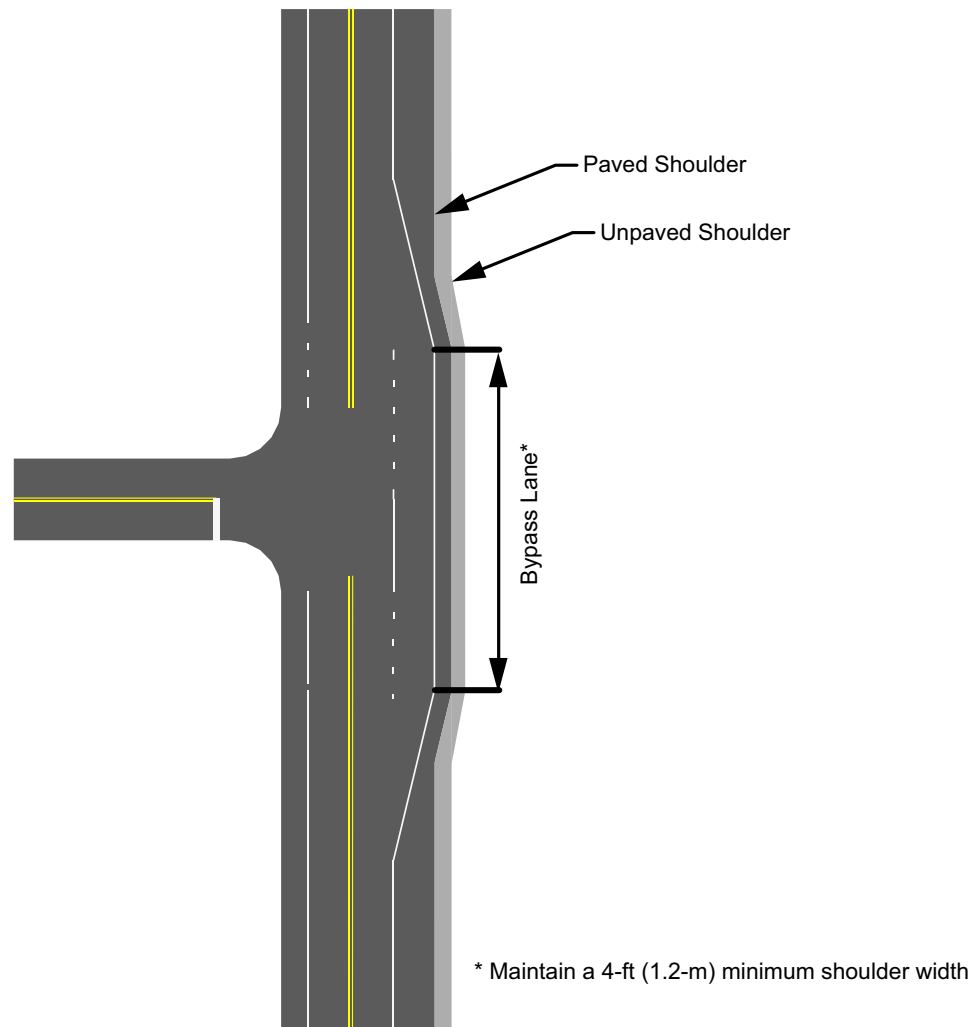

Figure 4-7. Shoulder Bypass Lane

4.5.2 Rumble Strips

Longitudinal rumble strips can provide an effective and inexpensive way to reduce run-off-road crashes for motorists on high-speed roadways. However, they can be difficult for bicyclists to traverse and can render popular and useful bicycle routes unrideable. The effect of some rumble strip designs on bicyclists can be significant; they can cause the bicycle to shudder violently, and therefore bicyclists prefer to avoid them. If rumble strips are located along the right edge of a roadway with a narrow shoulder or no shoulder space, bicyclists will need to share the travel lane with motorists.

Rumble strips are not recommended on shoulders used by bicyclists unless there is a minimum clear path of 4 ft (1.2 m) from the rumble strip to the outside edge of a paved shoulder, or 5 ft (1.5 m) to the adjacent curb, guardrail, or other obstacle. If existing conditions preclude achieving the minimum desirable clearance, the length of the rumble strip may be decreased or other alternative solutions considered. Placing a rumble strip under the edge line is one way to reduce its impact on the adjacent shoulder, while providing the additional advantage of increasing the visibility of the edge line at night.

Periodic gaps in rumble strips should be provided to allow bicyclists to move across the rumble strip pattern as needed (e.g., to avoid debris in the shoulder, pass other bicyclists, make left turns, and so forth.). Gaps spaced at intervals of 40 to 60 ft (12 to 18 m) provide such opportunities. A gap length of at least 12 ft (3.7 m) will allow most bicyclists to leave or enter the shoulder without crossing the rumble strip, as shown in Figure 4-8. Longer gaps should be provided on steep downgrades because of higher bicycle speeds.

Figure 4-9 illustrates the design parameters associated with shoulder rumble strips. Where bicycle traffic can be expected, bicycle-tolerable rumble strips can be designed as follows:

- Width: 5 in. (127 mm) parallel to the traveled way
- Depth: 0.375 in. (10 mm)
- Spacing: 11 to 12 in. (280 to 305 mm) center-to-center (11)

Depending upon the placement of the rumble strip relative to the edgeline and the width of the paved shoulder, it may be desirable to design the rumble strips with a relatively short length to provide a clear path for bicyclists. In such cases, the rumble strip length may be as short as 6 in. (152 mm) (11). In areas not prone to snow removal activity, an inverted profile (audible-vibratory) edge line marking can also be used as a more bicycle-friendly alternative to rumble strips, but will likely not generate the same level of stimuli (i.e., noise and vibration) as a typical milled rumble strip.

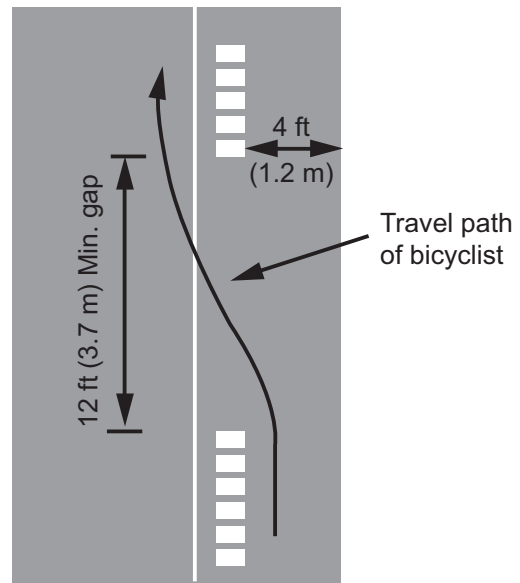
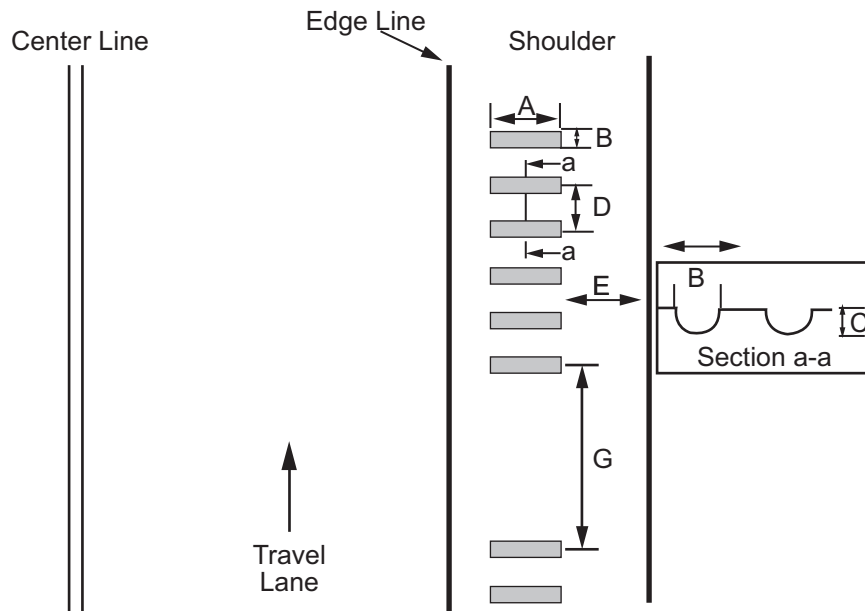

Figure 4-8. Rumble Strips



Definitions:	
Length (A)	Dimension of rumble strip measured lateral to the travel lane.
Width (B)	Dimension of the rumble strip measured parallel to the travel lane.
Depth (C)	Dimension of the vertical distance measured from the top of the pavement surface to the bottom of a rumble strip pattern.
Spacing (D)	Dimension of the distance between rumble strip patterns.
Clear Path (E)	Distance from the outside (i.e., right) edge of the rumble strip to the outside edge of the paved shoulder.
Gap (G)	Distance measured parallel to the roadway, between groups of rumble strip patterns.

Note: Figure not to scale.

Figure 4-9. Rumble Strip Design Parameters

Centerline rumble strips are used to reduce the potential for head-on collisions. A potential concern with centerline rumble strips is that the rumble strips may lead motorists to shy away from the centerline and move closer to bicyclists riding near the outside edge of the travel lane, leaving less lateral separation between a bicyclist and a motor vehicle during passing maneuvers. Where centerline rumble strips are used, shoulder rumble strips should be used only where a full-width paved shoulder of 6 ft (1.8 m) or more is provided (or a minimum clear path of 4 ft (1.2 m) from the rumble strip to the outside edge of a paved shoulder or 5 ft (1.5 m) to the nearest obstacle is provided). The dimensions for shoulder rumble strips described above should be used. In addition, the use of an inverted-profile (audible-vibratory) centerline marking may be more conducive should motorists need to cross the centerline to pass bicyclists.

4.6 BICYCLE LANES

4.6.1 General Considerations

Bicycle lanes are a portion of the roadway designated for preferential use by bicyclists. They are one-way facilities that typically carry bicycle traffic in the same direction as adjacent motor vehicle traffic. Bike lanes are the appropriate and preferred bicycle facility for thoroughfares in both urban and suburban areas. Where desired, or where there is a high potential for bicycle use, bike lanes may be provided on rural roadways near urban areas. Paved shoulders may be designated as bike lanes by installing bike lane symbol markings (see Figure 4-10); however, a shoulder marked as a bike lane will still need to meet the criteria listed elsewhere in this chapter.

Bike lanes are used to delineate available road space for preferential use by bicyclists. Bike lanes enable bicyclists to ride at their preferred speed, even when adjacent traffic speeds up or slows down. Bike lanes also encourage bicyclists to ride on the roadway in a position where they are more likely to be seen by motorists entering or exiting the roadway than they would be if riding on sidewalks. Properly designed bike lanes encourage bicyclists to operate in a manner consistent with the legal and effective operation of all vehicles. Bike lanes should follow travel paths that lawfully operating bicyclists would take to travel in their intended direction within the roadway cross section. Bike lanes are not intended to accommodate all bicycle use on a roadway; bicyclists may leave a bike lane to pass other bicyclists, make left turns or right turns, avoid debris or other objects, or to pass buses or other vehicles momentarily stopped in the bike lane. Raised pavement markings, raised curbs, and other raised devices can cause steering difficulties for bicyclists and should not be used to separate bike lanes from adjacent travel lanes.

Bike lanes should have a smooth riding surface. Utility covers should be adjusted flush with the surface of the lane. Bike lanes should be provided with adequate drainage (bicycle-compatible drain grates) to prevent ponding of water, washouts, debris accumulation, and other potential concerns for bicyclists. In addition, other roadway features should be compatible for bicycling. See Section 4.12 for more information on this topic.

State laws and local ordinances should be considered when implementing bike lanes, as they may have an impact on bike lane design, such as the placement of dashed lane lines. Motorists are prohibited from using bike lanes for driving, but many state vehicle codes allow or direct drivers to use bike lanes while turning or merging, maneuvering into or out of parking spaces, and for emergency avoidance maneuvers or breakdowns. Some state codes also allow buses, garbage collectors, and other public vehicles to use bike lanes temporarily and do not prohibit parking in bike lanes unless a local agency prohibits parking and erects signs accordingly. For information on retrofitting bike lanes onto existing streets, see Section 4.9.



Figure 4-10. Example of Paved Shoulder Designated as Bicycle Lane
(Photo courtesy of Michael E. Jackson.)

4.6.2 Bicycle Lanes on Two-Way Streets

In most cases, bike lanes should be provided on both sides of two-way streets. A bike lane provided on only one side may invite wrong-way use. Exceptions can be made on streets with an appreciable grade. On streets where downhill grades are long enough to result in bicycle speeds similar to typical motor vehicle speeds, then a bike lane may be provided only in the uphill direction, with shared-lane markings in the downhill direction (see Figure 4-11). This design can be especially advantageous on streets where fast downhill bicycle speeds have the potential to increase the likelihood of crashes with fixed objects, particularly in locations with on-street parking. Another potential exception is where a roadway narrows on one side of a roadway for a short segment with an otherwise continuous bike lane.

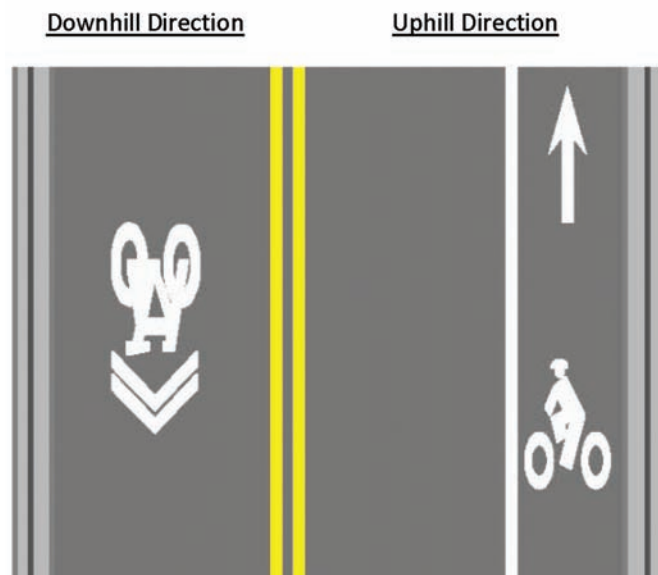

Figure 4-11. Shared-Lane Marking and Bike Lane on Steep Street

4.6.3 Bicycle Lanes on One-Way Streets

On one-way streets, bike lanes should normally be on the right-hand side of the roadway. A bike lane may be placed on the left if there are a significant number of left turning bicyclists or if a left-side bike lane decreases conflicts, for example those caused by heavy bus traffic, heavy right-turn movements (including double right-turn lanes), deliveries, or on-street parking.

Bike lanes should typically be provided on both streets of a one-way couplet in order to provide facilities in both directions and discourage wrong-way riding. If width constraints or other conditions make it impracticable to provide bike lanes on both streets, shared-lane markings should be considered on the constrained street. This provides a more complete network and encourages bicyclists to travel with the flow of other traffic.

On streets designated for one-way operation, it is sometimes desirable to provide an exception for bicyclists by marking a contra-flow bike lane on the appropriate side, separated by a yellow centerline marking. This may be considered in situations where it would provide substantial savings in out-of-direction travel and/or direct access to high-use destinations, and/or where there

will be fewer conflicts when compared to a route on other streets. This design is best used where there are few intersecting driveways, alleys, or streets on the side of the street with the contra-flow lane, and where bicyclists can effectively and conveniently make transitions at the termini of the contra-flow lane (see Figure 4-12). Such transitions are normally made at intersections.

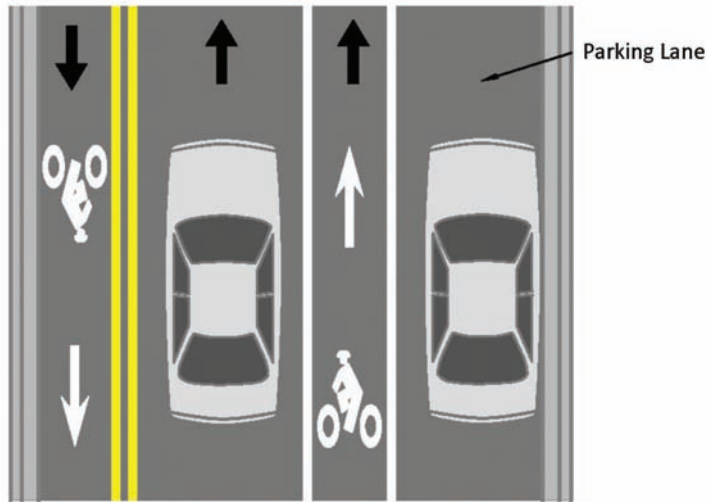

Figure 4-12. Typical Markings for One-Way Street Designed for Two-Way Bicycle Travel

For a bike lane to function as intended when built against the dominant flow of traffic on a one-way street, the following features should be incorporated into the design:

- The bike lane should be placed on the correct side of the roadway (i.e., the right-hand side, from the perspective of the bicyclist traveling in the contra-flow direction; or on the left-hand side from the motorist’s perspective).
- A bike lane should be provided for bicyclists traveling in the same direction as motor vehicle traffic. If there is insufficient room to provide a bike lane in the dominant-flow direction of the street, shared-lane markings should be considered to emphasize that bicyclists must share the travel lane on this side of the street.
- Where parking is present along a contra-flow bike lane, motorists leaving a parking space will have difficulty seeing oncoming bicyclists in the contra-flow bike lane, as sight lines may be blocked by other parked vehicles. For this reason, the provision of contra-flow bike lanes should be discouraged where parking is present on the same side of street.
- Bike lane symbols and directional arrows should be used on both the approach and departure of each intersection, to remind bicyclists to use the bike lane in the appropriate direction, and to remind motorists to expect two-way bicycle traffic.
- Appropriate separation should be placed between the two directions of traffic to designate travel lanes in both directions:

- ▶ Pavement markings are the simplest form of separation and should consist of two solid yellow lines, the standard centerline marking where passing (across the centerline) is prohibited in both directions.
- ▶ Medians or traffic separators provide more separation between motorists and bicyclists traveling in opposing directions. This treatment should be considered in situations with higher speeds or volumes. If medians or traffic separators are used, the contra-flow bike lane width should be at least 7 ft (2.1 m).
- ➡ At intersecting streets, alleys, and major driveways, “DO NOT ENTER” signs and turn restriction signs should include supplemental plaque that says “EXCEPT BICYCLES,” to establish that the street is two-way for bicyclists and to remind motorists to expect two-way bicycle traffic.
- ➡ At traffic signals, signal heads should be provided for contra-flow bicyclists, as well as suitable bicycle detection measures. A supplemental plaque that says “BICYCLE SIGNAL” may be needed beneath the signal to clarify its purpose.

4.6.4 Bicycle Lane Widths

Bicycle lane widths should be determined by context and anticipated use. The speed, volume, and type of vehicles in adjacent lanes significantly affect bicyclists’ comfort and desire for lateral separation from other vehicles. Bike lane widths should be measured from the center of the bike lane line. The appropriate width should take into account design features at the right edge of the bicycle lane, such as the curb, gutter, on-street parking lane, or guardrail. Figure 4-13 shows two typical locations for bicycle lanes in relation to the rest of the roadway, and the widths associated with these facilities.

As discussed in the previous chapter, a bicyclist’s preferred operating width is 5 ft (1.5 m). Therefore, under most circumstances the recommended width for bike lanes is 5 ft (1.5 m). Wider bicycle lanes may be desirable under the following conditions:

- ➡ Adjacent to a narrow parking lane (7 ft [2.1 m]) with high turnover (such as those servicing restaurants, shops, or entertainment venues), a wider bicycle lane (6–7 ft or 1.8–2.1 m) provides more operating space for bicyclists to ride out of the area of opening vehicle doors.
- ➡ In areas with high bicycle use and without on-street parking, a bicycle lane width of 6 to 8 ft (1.8–2.4 m) makes it possible for bicyclists to ride side-by-side or pass each other without leaving the lane.
- ➡ On high-speed (greater than 45 mph [70 km/h]) and high-volume roadways, or where there is a substantial volume of heavy vehicles, a wide bicycle lane provides additional lateral separation between motor vehicles and bicycles to minimize wind blast and other effects.

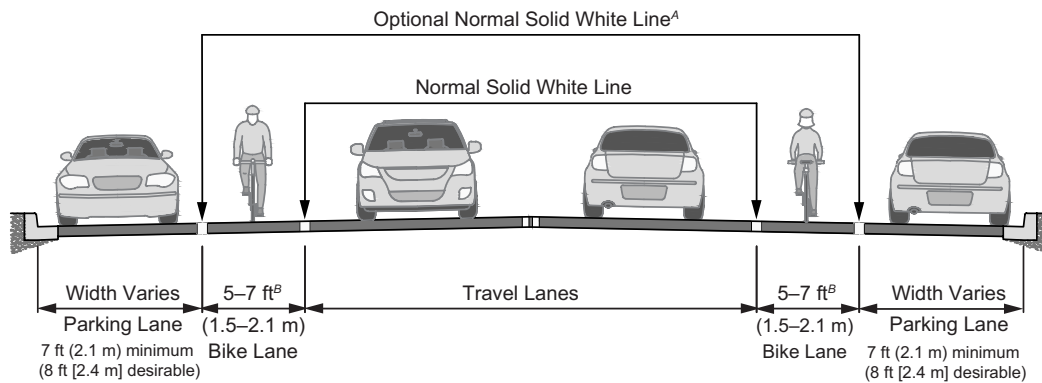

On Street Parking

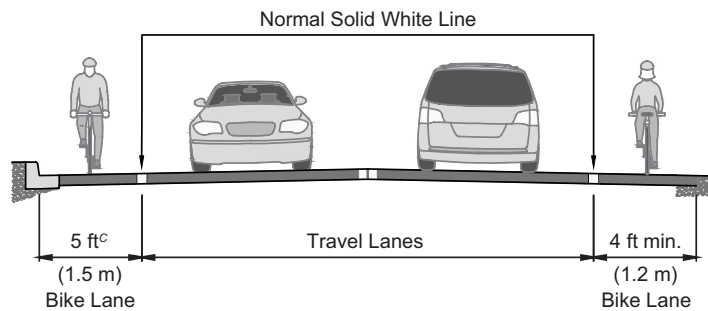

Parking Prohibited

Notes:

- ^A An optional normal (4–6-in./100–150-mm) solid white line may be helpful even when no parking stalls are marked (because parking is light), to make the presence of a bicycle lane more evident. Parking stall markings may also be used.
- ^B Bike lanes up to 7 ft (2.1 m) in width may be considered adjacent to narrow parking lanes with high turnover.
- ^C On extremely constrained, low-speed roadways (45 mph [70 km/h] or less) with curbs but no gutter, where the preferred bike lane width cannot be achieved despite narrowing all other travel lanes to their minimum widths, a 4-ft (1.2-m) wide bike lane can be used.

Figure 4-13. Typical Bike Lane Cross Sections

Where bicycle lanes are provided, appropriate marking or signing should be used so the lanes are not mistaken for motor-vehicle travel lanes or parking areas. For roadways with no curb and gutter and no on-street parking, the minimum width of a bicycle lane is 4 ft (1.2 m). For roadways where the bike lane is immediately adjacent to a curb, guardrails, or other vertical surface, the minimum bike lane width is 5 ft (1.5 m), measured from the face of a curb or vertical surface to the center of the bike lane line. There are two exceptions to this:

- In locations with higher motor-vehicle speeds where a 2-ft (0.6 m) wide gutter is used, the preferred bike lane width is 6 ft (1.8 m), inclusive of the gutter.
- On extremely constrained, low-speed roadways with curbs but no gutter, where the preferred bike lane width cannot be achieved despite narrowing all other travel lanes to their minimum widths, a 4-ft (1.2 m) wide bike lane can be used.

Along sections of roadway with curb and gutter, a usable width of 4 ft (1.2 m) measured from the longitudinal joint to the center of the bike lane line is recommended. Drainage inlets and

utility covers are sometimes built so they extend past the longitudinal gutter joint. Drain inlets and utility covers that extend into the bike lane may cause bicyclists to swerve, and have the effect of reducing the usable width of the lane. This is a particular concern if the minimum operating width of the lane falls below 4 ft (1.2 m). Therefore, the width of the bike lane should be adjusted accordingly, or else the structures should be removed. Also, bicycle-compatible grates should be used (see Section 4.12.8).

4.6.5 Bicycle Lanes and On-Street Parking

Where on-street parking is permitted, the bike lane should be placed between the parking lane and the travel lane (see Figure 4-14). The recommended bike lane width in these locations is 6 ft (1.8 m) and the minimum bike lane width is 5 ft (1.5 m). Care should be taken when providing wider bike lanes in areas where parking is scarce or otherwise in demand, as wider bike lanes may result in more double parking. As noted in Section 4.6.4, a bike lane width of 6 to 7 ft (1.8 to 2.1 m) may be desirable adjacent to a narrow parking lane with high parking turnover.



Figure 4-14. Example of Bike Lane Adjacent to Parallel Parking (Photo courtesy of Jennifer Toole of Toole Design Group.)

Bike lanes should not be placed between the parking lane and the curb. Such placement reduces visibility at driveways and intersections, increases conflicts with opening car doors, complicates maintenance, and prevents bike lane users from making convenient left turns.

Parallel Parking

Where bike lanes are installed adjacent to parallel parking, the recommended width of a marked parking lane is 8 ft (2.4 m), and the minimum width is 7 ft (2.1 m). Where parallel parking is permitted but a parking lane line or stall markings are not utilized, the recommended width of the shared bicycle and parking lane is 13 ft (4 m). A minimum width of 12 ft (3.7 m) may be satisfactory if parking usage is low and turnover is infrequent.

In general, it is the legal responsibility of motorists to check for oncoming traffic before opening a car door into the traveled way. However, motorists do not always fulfill their legal responsibility in this respect. In some urban areas, bicyclists have been seriously injured in crashes with car doors that are suddenly swung open by inattentive drivers and passengers. This type of crash is more prevalent in locations with high parking turnover, such as main streets, commercial streets with restaurants and retail businesses, or similar areas. Bicyclists can avoid this type of crash by riding on the left side of a bike lane, outside the range into which opened doors of parked vehicles could extend. Several communities employ markings to encourage bicyclists to ride further from parked cars, such as providing a wider parking lane, a wider bike lane, or a striped buffer between the parking lane and the bike lane. Parking “Ts” extending into the bike lane and bike lane symbols placed on the left side of the bike lane may encourage bicyclists to ride in a more appropriate location.

Diagonal Parking

In areas with high parking demand and sufficient street width, diagonal parking is sometimes used to increase parking capacity and reduce travel speeds on streets that are excessively wide. Bike lanes should normally not be placed adjacent to conventional front-in diagonal parking, since drivers backing out of parking spaces have poor visibility of bicyclists in the bike lane.

The use of back-in diagonal parking (see Figure 4-15) can help mitigate the conflicts normally associated with bike lanes adjacent to angled parking. There can be numerous benefits to back-in diagonal parking for all roadway users:

- Improved sight distance between exiting motorists and other traffic compared to parallel parking or front-in angled parking.
- No conflict between bicyclists and open car doors.
- Easier loading/unloading of vehicles.
- Passengers (including children) are naturally channeled toward the curb when alighting.
- Loading and unloading of the trunk occurs at the curb, not in the street.

When bike lanes are placed adjacent to back-in diagonal parking spaces, parking bays should be long enough to accommodate most types of vehicles.



Figure 4-15. Example of Bike Lane Adjacent to Back-in Diagonal Parking (Photo courtesy of William Schultheiss of Toole Design Group.)

4.7 BICYCLE LANE MARKINGS AND SIGNS

Bike lanes are designated for preferential use by bicyclists with a solid white line (4 to 6-in. or 100 to 150-mm wide) and one of the (two) standard bike lane symbol markings (see Figure 4-17 later in this chapter), which may be supplemented with the directional arrow marking. Optional bike lane signs may be used to supplement the pavement markings. Standards and guidance for applying these elements can be found in the MUTCD (3). Supplemental guidance is provided in Section 4.7.1.

4.7.1 Bicycle Lane Lines

A bike lane should be delineated from the adjacent travel lanes with a solid white line. Bike lane lines can be dotted at locations where motor vehicles are permitted to enter the bike lane and drive in it to prepare for a right-turn maneuver. Details about using dotted lines at intersections are provided in Section 4.8. Bike lanes can also be dotted at bus stops or bus pullouts. Bike lane

lines should remain solid and not dotted at minor unsignalized driveways and alleys (see Figure 4-16). At major driveways, the bike lane lines should be discontinued or dotted lines are optional.

Raised pavement markers, curbs, posts, or barriers should not be used to separate bike lanes from adjacent travel lanes. Raised devices are difficult for bicyclists to traverse because they are fixed to the pavement surface immediately adjacent to the travel path of the bicyclist. In addition, raised devices may discourage or prevent right-turning motorists from merging into the bike lane before turning. Raised devices can also make it more difficult to maintain the bike lane. A solid white line can be used to indicate the outside edge of the bike lane in locations with no curbs or where the edge of the roadway is poorly defined.

Where a bike lane is adjacent to a parking lane, the parking area should be defined by parking space “T” markings or a solid white line. Such markings encourage parking closer to the curb and can help make clear, during times of low parking usage, that the parking lane and bike lane are not lanes intended for motor-vehicle travel. More information on bike lanes adjacent to on-street parking can be found in Section 4.6.5.

Striped buffers may be used to provide increased separation between a bike lane and another adjacent lane that may present conflicts, such as a parking lane with high turnover or a higher-speed travel lane. The benefits of additional lateral separation should be weighed against the disadvantages; a buffer between the bike lane and the adjacent lanes places bicyclists further from the normal sight lines of motorists, who are primarily looking for vehicles in the lanes intended for motor-vehicle travel, and buffers between the bike lane and an adjacent travel lane reduce the natural “sweeping” effect of passing motor vehicles, potentially requiring more frequent maintenance.

4.7.2 Bicycle Lane Markings

As detailed in the MUTCD (3), a bike lane should be marked with standard bike lane markings (see Figure 4-17) to inform bicyclists and motorists of the restricted nature of the bike lane. Markings should be placed after each intersection or signalized driveway. Additional standard bike lane markings may also be placed in a visible location in a bike lane on the intersection approach (prior to the crosswalk). In general, due to the complexity of urban streets, flexibility is needed in placing bike lane markings.

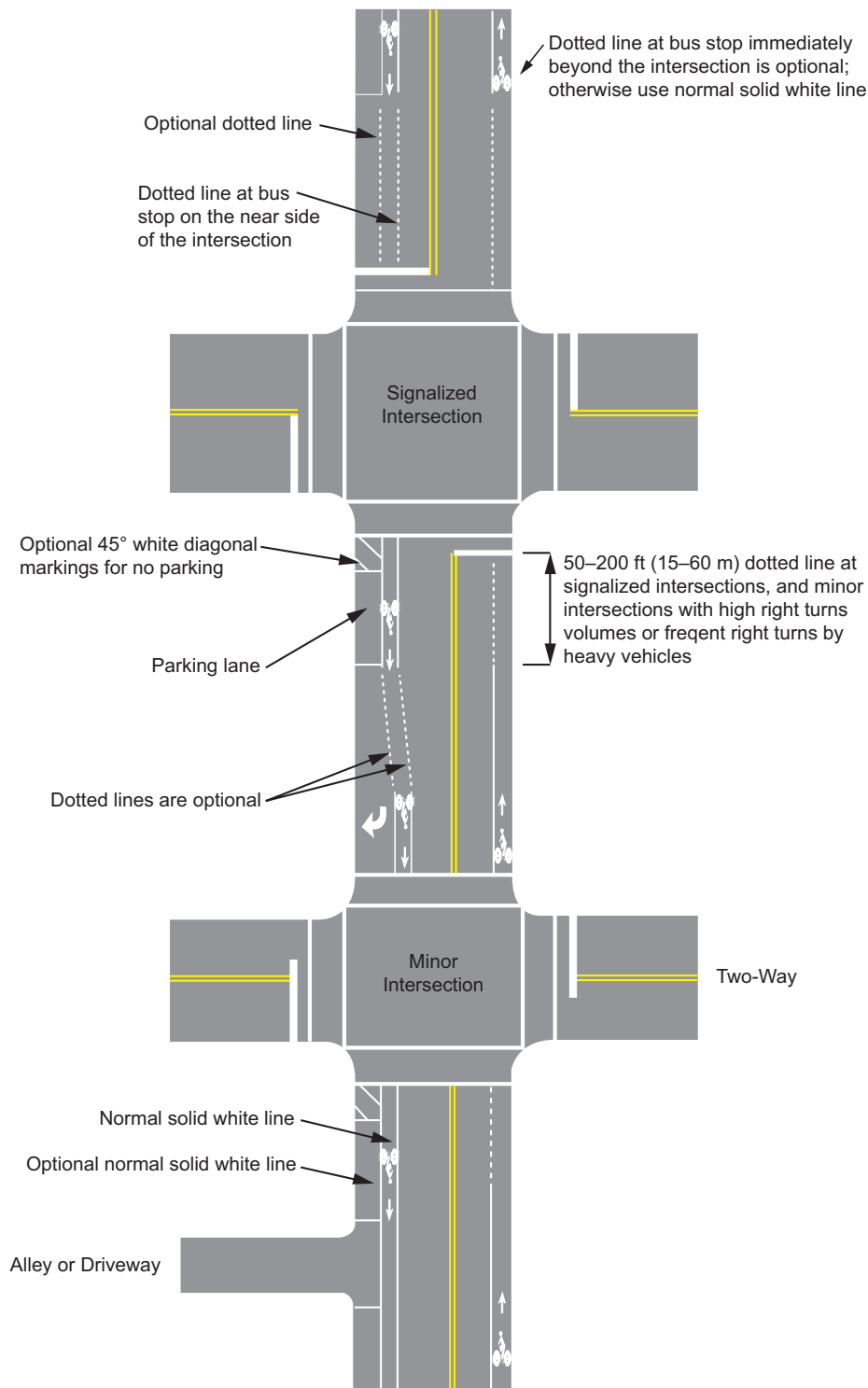

Note: At major driveways, the bike lane lines should be discontinued or dotted lines are optional.

Figure 4-16. Typical Bike Lane Pavement Markings

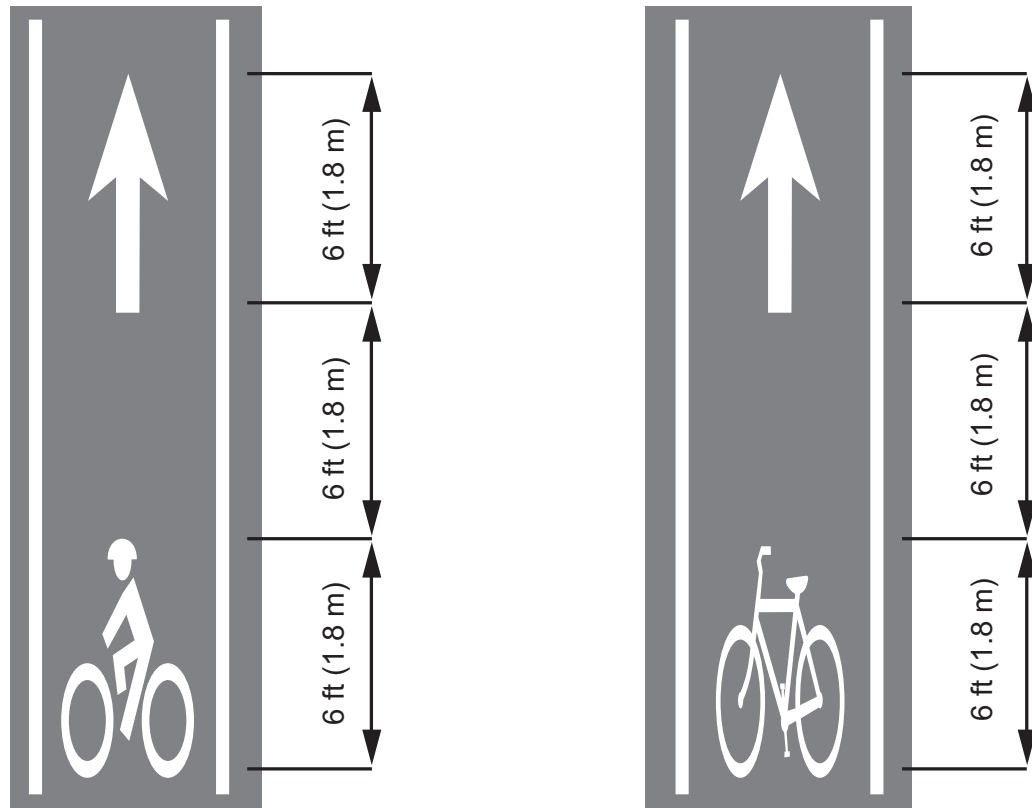

Figure 4-17. Bike Lane Symbol Markings

Additional markings may be placed at periodic intervals on bike lanes, to remind motorists of the potential presence of bicyclists, especially in areas where motorists are expected to cross bike lanes. In suburban areas with long distances between intersections and little roadside activity, bike lane symbols can be as far apart as 1000 ft (305 m) or more. In urban areas where motorists make parking maneuvers across bike lanes or where there is significant driveway density, it may be appropriate to space the symbols as often as every 100 ft (30 m).

The MUTCD (3) allows one of the two standard bike lane symbol markings (or the words “BIKE LANE”) and a directional arrow as shown in Figure 4-17. All bike lane markings should be white and retroreflective. Care should be taken to avoid placing symbols in areas where turning motor vehicles would damage or obliterate the markings, e.g., at driveways and the area immediately adjacent to an intersection (Figure 4-18).

Based upon Interim Approval issued by FHWA in April 2011, contrasting green color pavement may be used in marked bike lanes, and in extensions of bike lanes through intersections and other traffic conflict areas, such as merge areas where turning vehicles must cross a through bike lane. Use of this treatment requires written approval from FHWA in accordance with Section 1A.10 of the MUTCD. Approval can be granted for a specific location, or for an entire jurisdictional area.

Colored pavement may be used to denote the presence and preferred position of bicyclists and an appropriate travel path within the traveled way. Green colored pavement can be installed for the entire length of the bike lane, for only a portion or portions of the bike lane, or as a rectangular

background behind standard MUTCD symbol and word markings. If used in conjunction with dotted lines, such as when extending a bike lane across an intersection, the colored marking can match the dotted line pattern, filling in the area connecting the opposing dotted line segments. Colored pavement should not replace or be used in lieu of the white dotted lines defined in the MUTCD. Green colored pavement may be retroreflective, but there is no requirement or recommendation that it be retroreflective.

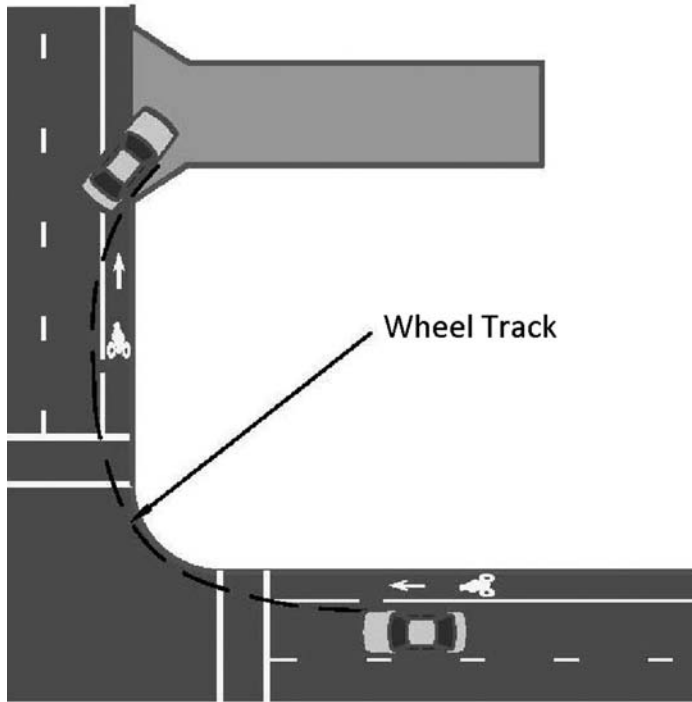

Figure 4-18. Example of Symbol Placement to Avoid Premature Wear

4.7.3 Bicycle Lane Signs

Due to the cluttered nature of the roadside in most urban areas, which reduces the effectiveness of signs, bike lane markings are typically the primary indication to motorists and bicyclists of the restricted nature of bike lanes. Signs may be used to supplement bike lane lines and markings; however they are less effective on streets with on-street parking.

The standard “BIKE LANE (R3-17)” sign (see Figure 4-19) with the “AHEAD (R3-17aP)” plaque may be placed in advance of the start (upstream end) of a bike lane. The “BIKE LANE” sign with the “ENDS (R3-17bP)” plaque should be placed at a sufficient distance to give warning to the bicyclist that the lane is ending. The “BIKE LANE ENDS” sign should not be used where a bike lane changes to an unmarked shoulder, for example at the urban or suburban fringe, or at temporary interruptions in a bike lane.



Figure 4-19. Bike Lane Sign

“BIKE LANE” signs may also be placed as needed at periodic intervals along a bike lane. Spacing of the sign should be determined by engineering judgment based on prevailing speed of bicycle and other traffic, block length, distances from adjacent intersections, and other considerations. Bike lane markings are typically used more frequently than “BIKE LANE” signs. Where the “BIKE LANE” sign is used, it should generally be placed adjacent to a bike lane pavement marking but not necessarily adjacent to every set of pavement markings to avoid over use of the signs.

If the installation of signs is needed to reduce the instances of parking, standing, or stopping in a bike lane, the “NO PARKING BIKE LANE” signs (R7-9 or R7-9a) or other signs restricting parking or stopping should be installed.

4.8 BICYCLE LANES AT INTERSECTIONS

Most conflicts between bicyclists and motor vehicles occur at intersections and driveways. The likelihood of crossing-path conflicts is increased because bicyclists are generally less conspicuous than motor vehicles and tend to ride along the periphery of the main traffic paths on which motorists concentrate their attention while navigating intersections.

Good intersection design clearly indicates to bicyclists and motorists how they should traverse the intersection and generally adheres to the following principles:

- Free-flow turning movements by motor vehicles should be avoided, or a bike lane should be provided.
- Provision of lighting is desirable for all users.
- The design should enable the bicyclist’s route through the intersection to be direct, logical, and similar to the path of motor-vehicle traffic.
- Actuated signals should be designed to detect the presence of bicyclists.
- Signal green intervals and clearance intervals should be sufficient to allow bicyclists to reach the far side of the intersection.
- Signals should be timed so they do not impede bicyclists with excessively long waits.
- Access management practices should be used to remove excessive conflict points.

Guidance on signal timing and bicycle detection is provided in Sections 4.12.4 and 4.12.5. Bike lanes are not normally striped through the middle of intersections; however, where extra guidance is needed, it may be appropriate to use a dotted extension line to guide bicyclists through an undefined area.

Compact intersections where roads meet at (or nearly at) right angles are most functional for bicyclists. Acute-angle intersections with three or four legs are less desirable because some turning movements can be made at higher speeds—which creates conflicts with bicyclists traveling straight. Also, trucks turning on obtuse angles have blind areas on their right sides. However, the presence of an acute-angle intersection along a candidate bicycle route should not disqualify it from designation if no convenient and preferable alternative route is available. Acute-angle intersections are often found in older built-up areas where diagonally intersecting streets often provide the most direct and practical bicycle access to destinations.

Various practices are used to improve the functionality of acute-angle intersections:

- Approaches can be realigned, as described in AASHTO's *A Policy on Geometric Design of Highways and Streets*.
- An intersection with more than four legs can be reconfigured so that only two roads cross, by closing a minor approach or by offsetting it to a new nearby minor intersection.
- Dotted bike lane extension lines can be used to guide bicyclists through long, undefined areas at large, skewed, or multi-leg intersections.
- A complex intersection can sometimes be converted to a roundabout.

4.8.1 Right Turn Considerations

Right Turn Considerations with Shared Through/Right-Turn Lanes

Right turns are relatively easy for bicyclists, since they typically ride on the right side of the roadway. On approaches to intersections that do not have right-turn-only lanes, bike lane lines are either solid or dotted (see Figure 4-16) or may be temporarily dropped. The choice between solid or dotted lines should be based on several factors, including the volume of right-turning motor vehicles, the presence of bus stops, the speed of motor vehicle traffic, the types of vehicles that typically use the intersection, and the context of the surrounding area (e.g., urban vs. suburban, and so forth). For example, dotted lines are more important where there are more right-turning vehicles, or where heavy vehicles frequently turn right. The dotted line is intended to provide a reminder that merging movements can be expected in this area.

State vehicle or traffic codes should be consulted as well, as the presence of a solid bike lane line at the approach to an intersection may discourage motorists from merging before turning right, as required by law in some states. This can result in conflicts when motorists turn across the path of bicyclists. In some states, a solid line may be interpreted as prohibiting a motorist from crossing the line to turn right. In such cases, a dotted marking should be used or the bike lane should be dropped on intersection approaches where right turns are permitted.

If a dotted line is used, it should begin 50 to 200 ft (15 to 60 m) prior to the crosswalk (or edge of the intersection if no crosswalk exists). The bike lane line should resume with a solid line on the far side of the intersection (outside crosswalk area).

Alternatively, rather than continuing a solid or dotted bike lane marking, bike lanes may also be dropped on an intersection approach. If the bike lane line is temporarily dropped, it should be dropped 50 to 200 ft (15 to 60 m) prior to the crosswalk (or the edge of the intersection if no crosswalk exists).

An intersection designed with large corner radii allows motorists to turn at higher speeds, thus making it more difficult for bicyclists to merge left. Corner radii should be as small as practical, but should be large enough to accommodate large vehicles (buses or heavy trucks) that frequently turn right at the intersection.

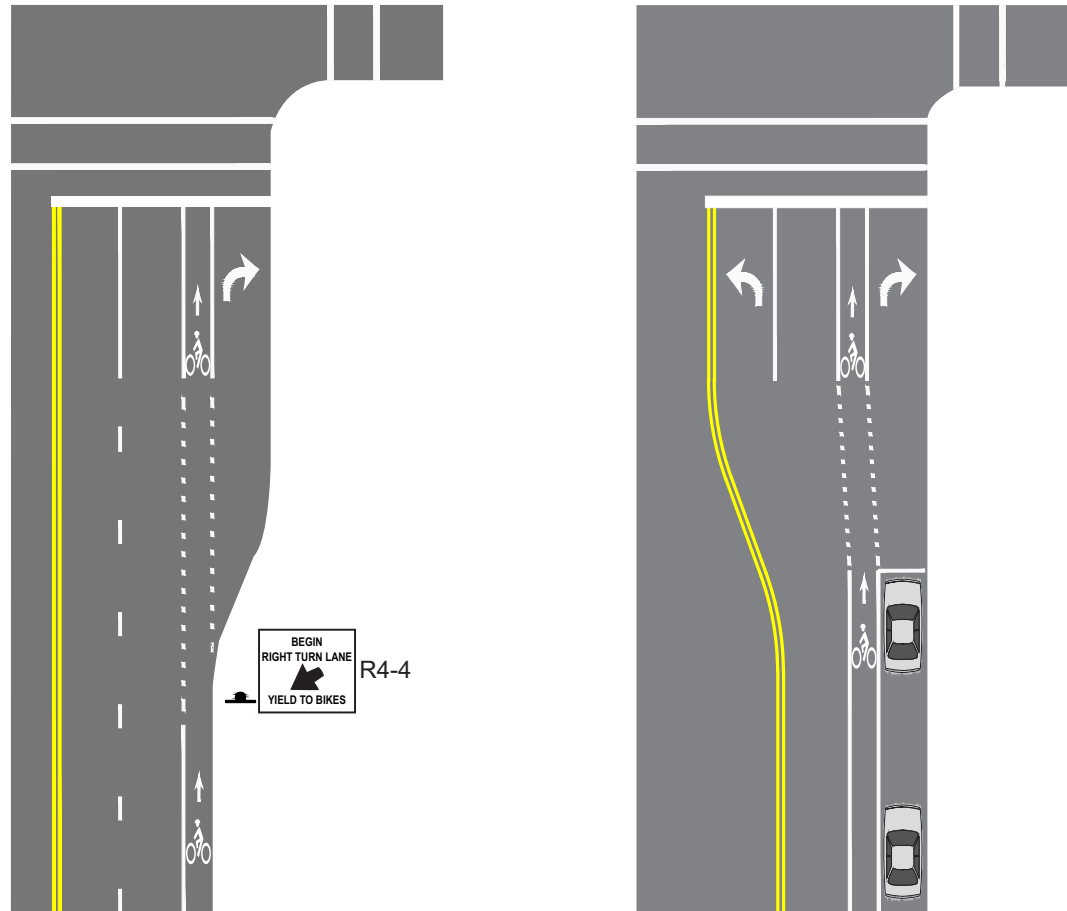

Note: Use of sign is optional.

Figure 4-20. Examples of Bike Lanes Approaching Right-Turn-Only Lanes (With and Without Parking)

Right Turn Considerations with Right-Turn-Only Lanes

Right-turn-only lanes are often used where high volumes of right-turning motor vehicle volumes warrant an exclusive right-turn lane to improve traffic flow. The correct placement of a bike lane is on the left of an exclusive right-turn lane, as shown in Figure 4-20. The through bike lane should be a minimum of 4 ft (1.2 m) wide, however 5 ft (1.5 m) is preferable to provide comfortable operating space. Bike lane lines should be used on both sides of the lane, per Section 4.7.2.

Incorporating the bike lane to the left of the right-turn-only lane enables bicyclists and right-turning motorists to sort their paths by destination in advance of the intersection, avoiding last-moment conflicts and providing the following benefits:

- Bicyclists are encouraged to follow the rules of the road: through vehicles (including bicyclists) proceed to the left of right-turning vehicles.
- Merging movements occur away from the intersection, and are often easier to manage for bicyclists and other road users than a turning conflict.

Motorists are required to yield to bicyclists at the entrance to the right-turn-only lane. The “BEGIN RIGHT TURN LANE YIELD TO BIKES (R4-4)” sign may be used to remind motorists entering the turn lane of their obligation to yield to bicyclists who are continuing through the intersection in the bike lane (because of the road rule that an operator leaving his lane yields to an operator on a path being entered or crossed).

In situations where a through travel lane becomes a right-turn-only lane (see Figure 4-21), bicyclists need to move laterally to weave across the travel lane. Therefore, the bike lane along the curb should be dropped, and a bike lane should be introduced on the left side of the right-turn lane. The bike lane line should not be striped diagonally across the travel lane, as this inappropriately suggests to bicyclists that they do not need to yield to motorists when moving laterally. This scenario is the least preferred option and should be avoided where practicable. In this situation, the “BEGIN RIGHT TURN LANE YIELD TO BIKES” sign should not be used, since bicyclists are the users who need to yield as they are weaving across the path of motor vehicle traffic.

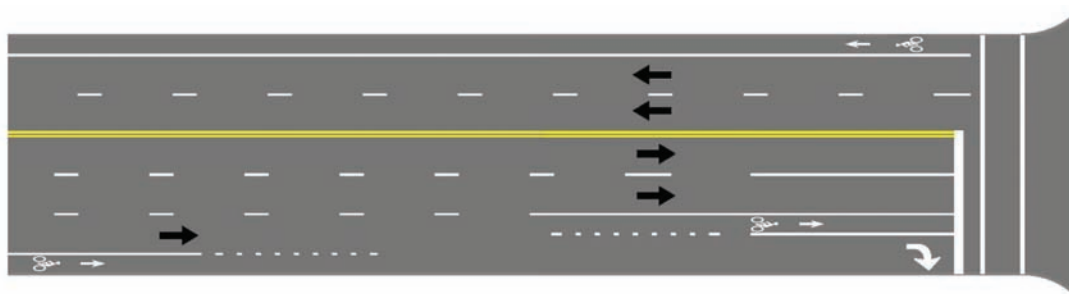

Figure 4-21. Example of Bike Lane with Through Lane Transitioning to Right-Turn-Only Lane

The use of dual right-turn-only lanes should be avoided on streets with bike lanes unless clearly needed to accommodate heavy right-turn volumes. Where there are dual right-turn-only lanes, the bike lane should be placed to the left of both right-turn lanes, in the same manner as where there is just one right-turn-only lane. On one-way streets with dual right-turn lanes, a bike lane on the left-hand side of the road may reduce conflicts and should therefore be considered (see Section 4.6.3).

An optional through right-turn lane next to a right-turn-only lane should not be used where there is a through bike lane. If a capacity analysis indicates the need for an optional through right-turn lane, the bike lane should be discontinued at the intersection approach. It may be possible to eliminate the through right option lane by using other methods of handling the right-turn traffic volume (e.g., two right-turn-only lanes as described above, or signal timing and phasing changes like additional green time or a right-turn overlap). An engineering analysis is needed in order to determine the feasibility of these options. If the lane assignment cannot be changed, shared-lane markings may be placed in the center of the through-right-option lane to provide additional guidance to bicyclists who wish to proceed straight.

At locations with heavy right-turn bicycle volumes, it may be appropriate to include a bicycle right-turn lane on the right side of the general right-turn lane. This design should only be considered where additional width can be provided so that turning vehicles will not encroach into the turning bicyclist's path. Wayfinding signage should be provided in advance of the turn lane, so bicyclists can select the appropriate lane. The receiving street should be compatible for bicycling. A through bike lane or shared-lane marking should also be included to guide bicyclists who want to continue straight (assuming this is a legal movement).

4.8.2 Left Turn Considerations

As described in Chapter 3, there are several methods for bicyclists to make left turns (see Figure 3-3). In two of the methods, the bicyclist merges left in advance of the intersection to turn from the same location as other left-turning vehicles. In the other method, the bicyclist proceeds straight through the intersection, stops on the far side of the intersection (at the corner) and turns the bicycle to the left, and then proceeds across the intersection again on the cross street, or as a pedestrian in the crosswalk. This method is more common in locations with high volumes of motor vehicles, and/or where there are high speeds, because it is more difficult for bicyclists to merge left.

Where there are considerable volumes of left-turning bicyclists, or where a designated or preferred bicycle route makes a left turn, it may be appropriate to provide a separate bicycle left-turn lane (see Figure 4-22). The figure shows a left-turn-only lane for bicyclists on a one-way street, but the same concept could also be applied on a two-way street.

Separate bicycle left-turn lanes may also be appropriate at intersections of shared use paths with streets, or at other locations where left turns are allowed for bicyclists but not motorists (e.g., onto a bicycle boulevard). At these locations, bicyclists wanting to turn left from the street system onto the path or bicycle boulevard would otherwise need to wait in the leftmost through travel lane for oncoming traffic to clear in the leftmost through travel lane, which is an exposed location.

As described in Section 4.6.3, it is sometimes appropriate to place a bike lane on the left side of a one-way street. In this situation, where a left-turn-only lane is provided on an approach, the bike lane should be continued to the right of the left-turn lane, analogous to the treatment for bike lanes with right-turn-only lanes described above. As a general rule, bike lanes should be terminated in advance of roundabouts. Design measures for bicyclists at roundabouts are described in Section 4.12.11.

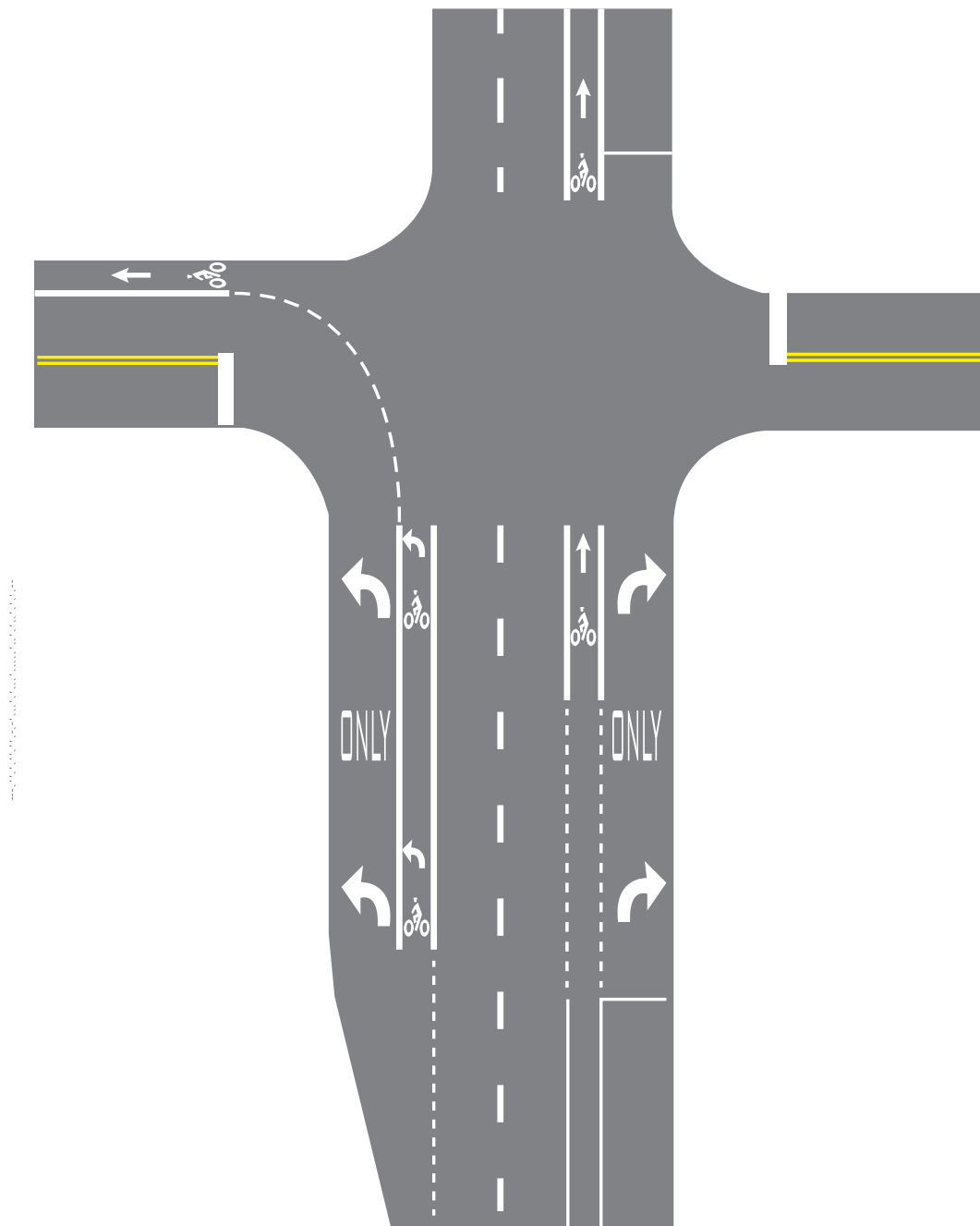

Figure 4-22. Example of Bike Left-Turn-Only Lane

4.9 RETROFITTING BICYCLE FACILITIES ON EXISTING STREETS AND HIGHWAYS

Existing streets and highways can be retrofitted to improve bicycle accommodations by either widening the roadway or by reconfiguring the existing roadway. On busier or higher-speed rural roads, paved shoulders can be added to improve mobility and comfort for bicyclists and reduce bicycle-related crashes. On urban (curbed) roadways, it may be possible to accommodate bike lanes by reconfiguring travel lanes or, where that is not practical, to make other adjustments that better accommodate bicyclists.

Roadway retrofits for bicycle facilities are best accomplished as part of a repaving or reconstruction project. This provides a clean slate for the new marking pattern, eliminating traces of the old lines that remain visible when pavement markings are either painted over or ground off the roadway surface. Where a retrofit involves road widening, completing the retrofit during a repaving project eliminates the potential for rough joints, reduces the possibility that a longitudinal joint will fall within a travel lane, and reduces costs since the construction crew is already mobilized and larger material quantities typically result in better prices. Agencies may find it beneficial to systematically review upcoming resurfacing projects to identify opportunities for bike lane and/or shoulder retrofits.

When retrofitting roads for bicycle facilities, the width guidelines for bike lanes and paved shoulders (see Sections 4.5 and 4.6.4) should be applied. However, undesignated paved shoulders can improve conditions for bicyclists on constrained roadways where obtaining the preferred shoulder widths is not practical. In these situations, a minimum of 3 ft (0.9 m) of operating space should be provided between the edge line and gutter joint (where curb and gutter is used), or a minimum of 4 ft (1.2 m) of operating space between the edge line and the edge of paved shoulder (where no curb is present) or the curb face (where curb is used without a gutter).

There are many factors beyond the scope of this guide that highway agencies should consider in choosing appropriate lane and shoulder widths for specific facilities (refer to *A Policy on Geometric Design of Highways and Streets (1)*). However, from the standpoint of accommodating bicyclists, it is generally preferable in retrofit situations to provide 3 to 4 ft (0.9 to 1.2 m) paved shoulder than to provide a narrower paved shoulder. Thus, in a retrofit situation, where the total width of the existing outside lane is 14 ft (4.3 m), it would generally be preferable for bicyclists to provide either a 10 to 11 ft (3.0 to 3.3 m) travel lane and a 3 to 4 ft (0.9 to 1.2 m) paved shoulder or to leave the 14 ft (4.3 m) outside lane width unchanged. By contrast, providing a 12 ft (3.6 m) travel lane and a 2 ft (0.6 m) shoulder provides limited space to ride and places bicyclists at a distinct disadvantage in comparison to the other alternatives.

Retrofitting bicycle facilities on bridges presents special challenges because it may be impractical to widen an existing bridge. The guidance in Section 4.9.2 for retrofitting bicycle facilities without roadway widening is applicable to existing bridges. Further guidance on accommodating bicyclists on bridges is presented in Section 4.12.3.

4.9.1 Retrofitting Bicycle Facilities by Widening the Roadway

Where right-of-way is adequate, or where additional right-of-way can be obtained, roads can be widened to provide wide outside lanes, paved shoulders, or bike lanes. The decision to widen the road should be weighed against the likelihood that vehicle speeds will increase, which may have adverse effects on bicyclists and pedestrians. In urban and suburban areas with sidewalks or foreseeable pedestrian use, the goal of improving bike accommodation should be balanced with the goal of maintaining a high-quality pedestrian environment, as well.

Where the pavement is being widened to provide paved shoulders or bike lanes, and no overlay project is scheduled, the following techniques can be used so that a rough joint is not placed in the shoulder where bicyclists ride:

- A saw cut located at the proposed edge line provides the opportunity to construct an even and tight joint. This eliminates a ragged joint at the edge of the existing pavement.
- Feathering the new asphalt onto existing pavement works if a fine mix is used, and the feather does not extend across the area traveled by bicyclists.
- Where there is already some shoulder width and thickness available, a pavement grinder can be used to make a clean cut at the edge of travel lane, with these advantages:
 - ▶ Less of the existing pavement is wasted.
 - ▶ The existing asphalt acts as a base.
 - ▶ There will not be a full-depth joint between the travel lane and the shoulder.
 - ▶ The grindings can be recycled as base for the widened portion.

4.9.2 Retrofitting Bicycle Facilities Without Roadway Widening

In many areas, especially built-out urban and suburban areas, physical widening is impractical, and bicycle facility retrofits have to be done within the existing paved width. There are three methods of modifying the allocation of roadway space to improve bicyclist accommodation:

1. Reduce or reallocate the width used by travel lanes.
2. Reduce the number of travel lanes.
3. Reconfigure or reduce on-street parking.

In most cases, travel lane widths can be reduced without any significant changes in levels of service for motorists. Before travel lane widths are reduced, an operational study should be performed to evaluate the impact of a specific lane reconfiguration. One benefit is that Bicycle LOS will be improved. Creating shoulders or bike lanes on roadways can improve pedestrian conditions as well by providing a buffer between the sidewalk and the roadway.

Other improvements on the outside portion of the roadway may also be needed during retrofit projects, including:

- Repairing rough or uneven pavement surfaces.
- Replacing standard drainage grates with a design that is compatible with bicycle use (see Section 4.12.8).
- Raising (or lowering) existing drainage grates and manhole or utility covers so they are flush with the pavement.
- Widening the roadway at spot locations to obtain adequate road width.

Where addition of bike lanes is planned as a retrofit project, there may be a portion of the roadway where there is insufficient width, resulting in a gap. Shared-lane markings can be used on short segments of narrower roadway to provide better continuity. In these situations, efforts to reduce traffic speeds may reduce crashes and encourage bicycling. If the constrained segment is more than a few blocks long, it may be advisable to improve an alternate route for bicycling; the alternate route should provide access to the same destinations.

Reducing Travel Lane Width

In some cases, the width needed for bike lanes or paved shoulders can be obtained by narrowing travel lanes. Lane widths on many roads are greater than the minimum values described by *A Policy on Geometric Design of Highways and Streets (1)* and, depending on conditions, may be candidates for narrowing.

A Policy on Geometric Design of Highways and Streets (1) contains criteria for determining appropriate lane widths and provides significant flexibility to use travel lanes as narrow as 10 ft (3.0 m) in a variety of situations. Evaluation of effects of travel lane widths of 10 to 12 ft (3.0 to 3.7 m) on crashes for urban arterial roadways has found no general indication that the use of narrower widths within this range increases crash rates (9). However, engineering judgment should be applied. Factors that should be considered include operating speeds, volumes, traffic mix, horizontal curvature, use of on-street parking, and street context, among others.

Reducing the Number of Travel Lanes

Reducing the number of travel lanes is often referred to as a “road diet” and is one method that can be used to integrate bike lanes on existing roadways. This is a strategy that can be used on streets with excess capacity (more travel lanes than needed to accommodate the existing or projected traffic volumes), especially between intersections (under typical circumstances, signalized intersections define the capacity of a street). This may be because the streets were built to accommodate a projected volume that never materialized, because traffic volumes have decreased due to population changes, because of changes in the transportation system, or because of changes in an agency’s level-of-service objectives.

Before implementing a road diet, a traffic study should be conducted to evaluate potential reductions in crash frequency and severity, to evaluate motor vehicle capacity and level of service, to evaluate Bicycle LOS, and to identify appropriate signalization modifications and lane assignment at intersections.

Road diets have many benefits, often reducing crashes; improving operations; and improving livability for pedestrians, bicyclists, adjacent residents, businesses, and motorists. A common lane reduction treatment is to convert an undivided four-lane (two-way) roadway to a three-lane roadway (central two-way left-turn lane; see Figure 4-23). Benefits of this type of road diet include:

- The additional space gained by removing one lane can be used to provide bike lanes or shoulders on both sides of the road.
- With one travel lane in each direction, top-end travel speeds are moderated by those who are following posted speed limits, which may reduce potential crash severities for all users.
- It may be feasible to include a raised median or small refuge islands at some pedestrian crossing locations, making it easier for pedestrians to cross the street and reducing the likelihood of pedestrian crashes.

Chapter 4: Design of On-Road Facilities

- The reduction from two lanes to one in each direction virtually eliminates the likelihood of “multiple threat” crashes (where a driver in one lane stops to yield, but the driver in the adjacent lane continues at speed) for pedestrians and left-turning motorists and bicyclists.
- Left-turn lanes provide a place for motorists and bicyclists to wait to make a left turn, reducing the incidence of left-turn, rear-end crashes.
- Sideswipe crashes are reduced since motorists no longer need to change lanes to pass a vehicle waiting to turn left from the leftmost through lane.
- Less traffic noise (due to reduced speeds) and greater separation from traffic for pedestrians, residents, and businesses.

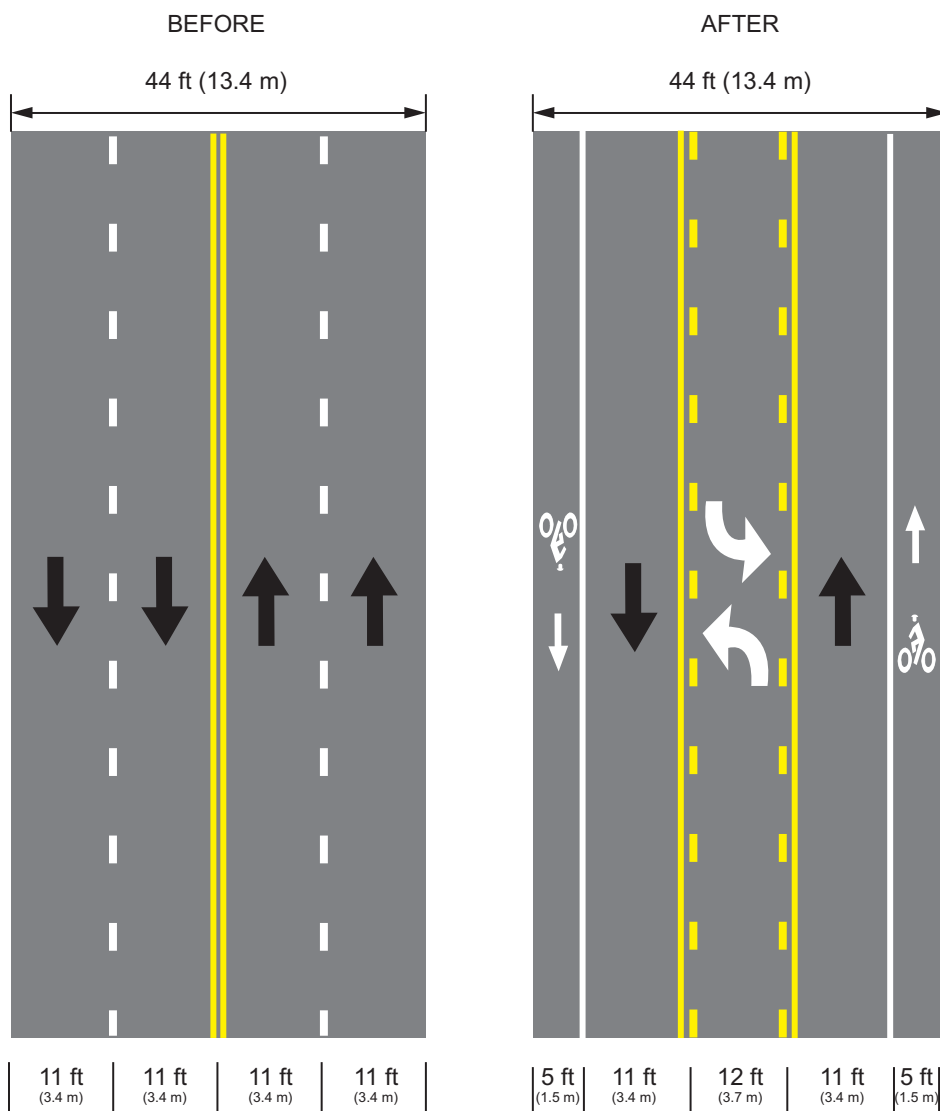

Figure 4-23. Example of Road Diet

These four-lane to three-lane conversions can have potential operational benefits as well, particularly on streets with high numbers of left-turning vehicles, which impede traffic in the leftmost through lane of a four-lane undivided street. Four-lane undivided streets with traffic volumes less than 15,000 vehicles per day are candidates for four-lane to three-lane conversion; streets with higher volumes usually need a more detailed engineering study that includes recommendations for signal timing changes and other enhancements at intersections. There are many examples of four-lane to three-lane conversions with 15,000 to 20,000 vehicles per day and a few examples where converted streets are carrying over 20,000 vehicles per day (5).



Figure 4-24. Road Diet—Before and After (Photo courtesy of Jennifer Selby.)

One-way streets may offer opportunities to install bike lanes through lane reductions. Many one-way couplets were originally two-way streets, and in the conversion, all available space was converted to one-way travel lanes. As a result, many one-way streets operate well below their capacity. Since only one bike lane is needed on a one-way street, removing a travel lane can provide additional space for other features such as on-street parking or wider sidewalks. As mentioned in Section 4.6.3, both legs of a one-way couplet should include bike lanes.

Reducing On-Street Parking

On-street parking has both positive and negative effects on various road users and neighbors. On-street parking may serve residents, help keep traditional street-oriented businesses viable, provide a buffer for pedestrians, and help keep traffic speeds down. But on-street parking can also create conflicts for bicyclists and motorists, and uses road width that might otherwise be used by bicyclists. Removing or reducing on-street parking involves careful negotiation with the affected businesses and residents. It may be possible to accommodate more parking on side streets, or to consolidate it in newly created parking bays or in shared (off-street) parking. A parking study can be conducted to determine if these (and other) solutions are feasible.

Removing Parking on One Side

On most streets with parking on both sides, removal of all on-street parking is not needed. One strategy is to remove parking from one side of a street, combined with minor additional lane narrowing. Typically, it is best to remove parking on the side of the street with fewer residences or businesses, or the side with residences rather than businesses. For roadways on steep grades, removal of parking in the uphill direction may be most appropriate. Parking need not be retained on the same side of the road through an entire corridor. Alternating parking from one side to the other can create a traffic calming effect as well.

Converting Diagonal Parking to Parallel Parking

Another strategy to add bike lanes is to convert diagonal parking to parallel parking. It is usually sufficient to convert only one side of a street to parallel parking, thereby reducing parking by less than one-fourth. To be compatible with bike lanes, any remaining diagonal parking may be converted to back-in diagonal parking (see Section 4.6.5).

4.10 BICYCLE BOULEVARDS

A bicycle boulevard is a local street or series of contiguous street segments that have been modified to function as a through street for bicyclists, while discouraging through automobile travel. Local access is maintained.

Bicycle boulevards create favorable conditions for bicycling by taking advantage of local streets and their inherently bicycle-friendly characteristics: low traffic volumes and operating speeds. However, without some improvements, local streets are usually not continuous enough to be used for long trips. For example, where they intersect a busy thoroughfare, it can be difficult for bicyclists to find adequate gaps to cross. Therefore, a series of physical and operational changes can be effective in helping bicyclists travel along a bicycle boulevard with relative ease.

Bicyclists riding on bicycle boulevards typically share the roadway with other traffic. Some segments may be on busier roads with bike lanes. In locations where street segments do not connect, short sections of paths may be used to connect cul-de-sacs and dead-end streets. Bicycle boulevards should be long enough to provide continuity over a distance typical of an average urban bicycle trip (2-5 mi [3-8 km]), but they can also be used for shorter distances when needed to connect path segments in constrained environments, or as a short segment on a route between a neighborhood and a school.

A bicycle boulevard incorporates several design elements to accommodate bicyclists. These may include, but are not limited to:

- Traffic diverters at key intersections to reduce through motor vehicle traffic while permitting passage for through bicyclists;
- At two-way, stop-controlled intersections, priority assignment that favors the bicycle boulevard, so bicyclists can ride with few interruptions;
- Neighborhood traffic circles and mini-roundabouts at minor intersections that slow motor vehicle traffic but allow bicyclists to maintain momentum (also see Section 4.12.11 on roundabouts);
- Other traffic-calming features to lower motor vehicle speeds where deemed appropriate;

- Wayfinding signs to guide bicyclists along the way and to key destinations;
- Shared-lane markings where appropriate to alert drivers to the path bicyclists need to take on a shared roadway; and
- Crossing improvements where the boulevard crosses major streets. Techniques for this purpose include, but are not limited to:
 - ▶ A traffic signal, where warranted, or a crossing beacon. To enable bicyclists to activate the signal, bicycle-sensitive loop detectors (with detector pavement markings), or push-buttons that do not require bicyclists to dismount are appropriate.
 - ▶ Median refuges wide enough to provide a refuge for bicyclists (8 ft [2.4 m] min) and with an opening wide enough to allow them to pass through (6 ft [1.8 m] min).
 - ▶ Curb extensions on a crossed thoroughfare with on-street parking, to allow approaching bicyclists an opportunity to pull past parked cars to get a better view of approaching traffic.

Not all bicycle boulevards will need all the treatments listed above. A local street may already have many of the desired characteristics and may only need wayfinding signs for continuity; other streets will need varying levels of treatment.

4.11 BICYCLE GUIDE SIGNS/WAYFINDING

Bicycle guide signs can help bicyclists navigate within and between a variety of destinations in urban, suburban, and rural areas. Several considerations for planning bicycle wayfinding systems are discussed in Chapter 2. The MUTCD (3) provides standards and guidelines for the design and placement of bicycle guide signs. This section provides supplemental information regarding these sign systems. As described in Chapter 2, there are several types of bicycle guide signs that can be used.



Figure 4-25. D11 Series Bicycle Route Signs

D Series Route Signs

The D series (green bike route sign and various destination plaques) includes the green “BIKE ROUTE” sign (D11-1),” as well as an alternative sign that replaces the words “BIKE ROUTE” with a destination or route name (D11-1c) (see Figure 4-25). Use of this alternative is preferred whenever practical, as it provides the rider with more useful information than the D11-1. Routes should be named with either a term that describes the corridor (for example, a route that generally follows a waterway or valley, or a route

that follows or parallels a well-known street), or a destination, using a relatively well-known place reference that is at the end of that specific route.

A variety of wayfinding destination sign options can be used either in conjunction with the D11 sign, or independently. D1 signs (see Figure 4-26) provide a combination of destination names,

arrows, and mileage information that can be very helpful to bicyclists. These signs can display up to three destinations in different directions and include a directional arrow and a bicycle symbol, plus a destination name (D1-1b, D1-2b, D1-3b), or a destination and a mileage (D1-1c, D1-2c, D1-3c). D1 signs intended for bicyclist guidance should include the bicycle symbol as shown in the MUTCD, unless the sign assembly already incorporates a D11 sign that contains a bicycle symbol.

Use of D-1 signs can eliminate the need for multiple D11 signs and supplementary plaques at bikeway intersections or direction changes and can greatly simplify the signing at these locations. A D11 sign can be used as a confirming route destination sign beyond the intersection or directional change.

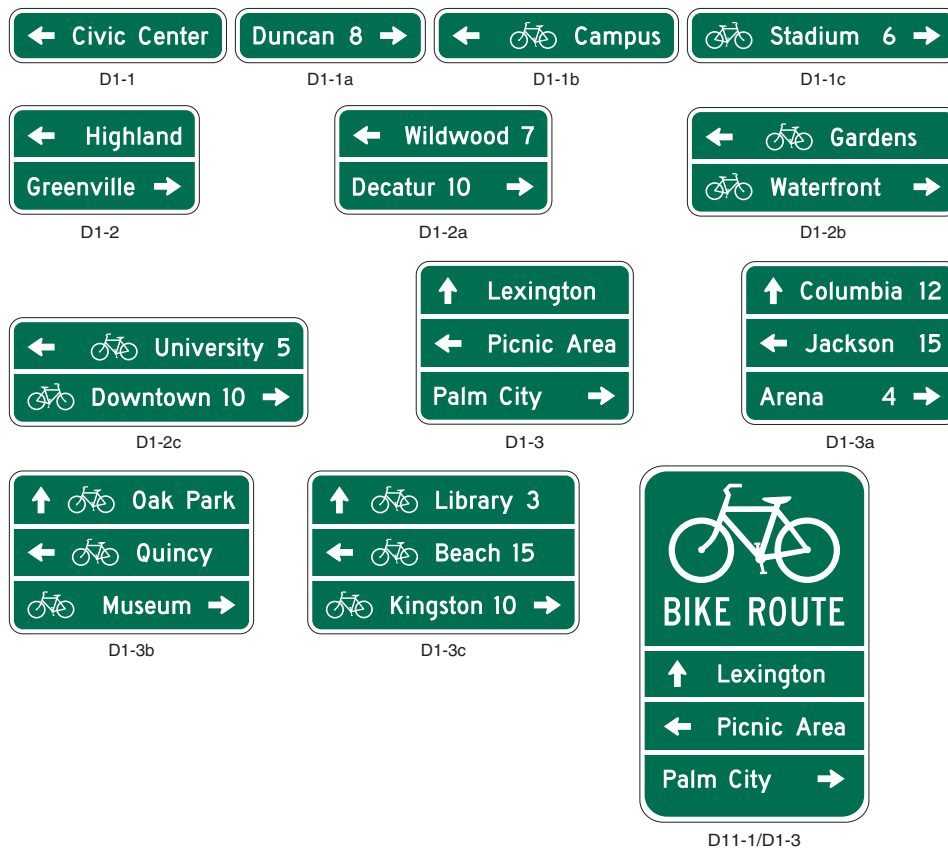

Figure 4-26. Wayfinding Signs

M1-8 Series Route Signs

The M1-8/M1-8a signs (see Figure 2-1) are appropriate for local and regional networks of numbered or lettered routes. Use of these signs almost always involves the production of a map or series of maps to aid the bicyclist in understanding what destinations are served by these routes. For this reason, they are generally more appropriate for longer distance routes, rather than shorter urban and suburban routes. When using numbered or lettered routes, it is important to use an organized system for designating the routes. For example a numbered route system could be set up to use even numbers for east-west routes and odd numbers for north-south routes.

M1-9 Route Signs

The M1-9 sign (see Figure 2-1) is used for AASHTO-approved U.S. Bicycle Routes that typically extend through two or more states. To designate such a route, a coordinated submittal should be made to AASHTO by the affected states. AASHTO provides the U.S. Bicycle Route number designation (2).

When to Use Bicycle Route and Guide Signs

Ideally, bike routes should be located on roads and shared use paths with favorable conditions for bicycling, including those with bicycle facilities, low motor vehicle volumes, low traffic speeds, or enough width for shoulders or appropriate lane sharing. Bicycle route designation or guide signs are useful for a variety of purposes including helping bicyclists navigate; however, the placement of wayfinding signs does not necessarily reduce bicycle crashes, because the signs do not alter the geometric design or traffic volume and speed of the roadway. For this reason, it may be desirable to supplement bicycle wayfinding signs with other roadway improvements to accommodate bicycle travel, depending upon motor vehicle speeds and volumes along the route.

Bicycle route and guide signs can be used to:

- Designate a system of routes in a city, county, region, or state that is likely to generate bicycle trips, because it connects important origins and destinations.
- Designate a continuous route that may be composed of a variety of facility types and settings, or located wholly on local neighborhood streets.
- Provide wayfinding guidance and connectivity between two or more major bicycle facilities, such as a street with bike lanes and a shared use path.
- Provide guidance and continuity in a gap between existing sections of a bikeway, such as a bike lane or shared use path.
- Provide location-specific guidance for bicyclists such as:
 - ▮ How to access and cross a bridge.
 - ▮ How to navigate through an area with a complex street layout.
 - ▮ Where the route diverges from a way used by motorists.
 - ▮ How bicyclists can navigate through a neighborhood to an internal destination, or to a through route that would otherwise be difficult to find.
- Provide bicyclists wayfinding guidance along a shared use path or other bicycle facility.

Bicycle guide signs should be visible to bicyclists and oriented so bicyclists have sufficient time to comprehend the sign and change their course, when needed. When appropriate, bicycle guide signs may be placed on existing posts and light poles to reduce sign and post clutter. However, the MUTCD prohibits displaying certain types of signs on the same post and should therefore be consulted (3).

Guide signs should be placed at locations where a bike route turns at an intersection, where bike routes cross one another, and where bike routes cross major roadways (see Figure 4-27). Directional arrows are typically horizontal or vertical; however, a sloping arrow may be used if it con-

veys a clearer indication of the direction bicyclists should travel. At large or complex intersections, it may be appropriate to place signs at both the near and far side or at multiple locations. In rural areas, guide signs should be placed at intersections with major roads and at appropriate intervals in sections with no intersections.

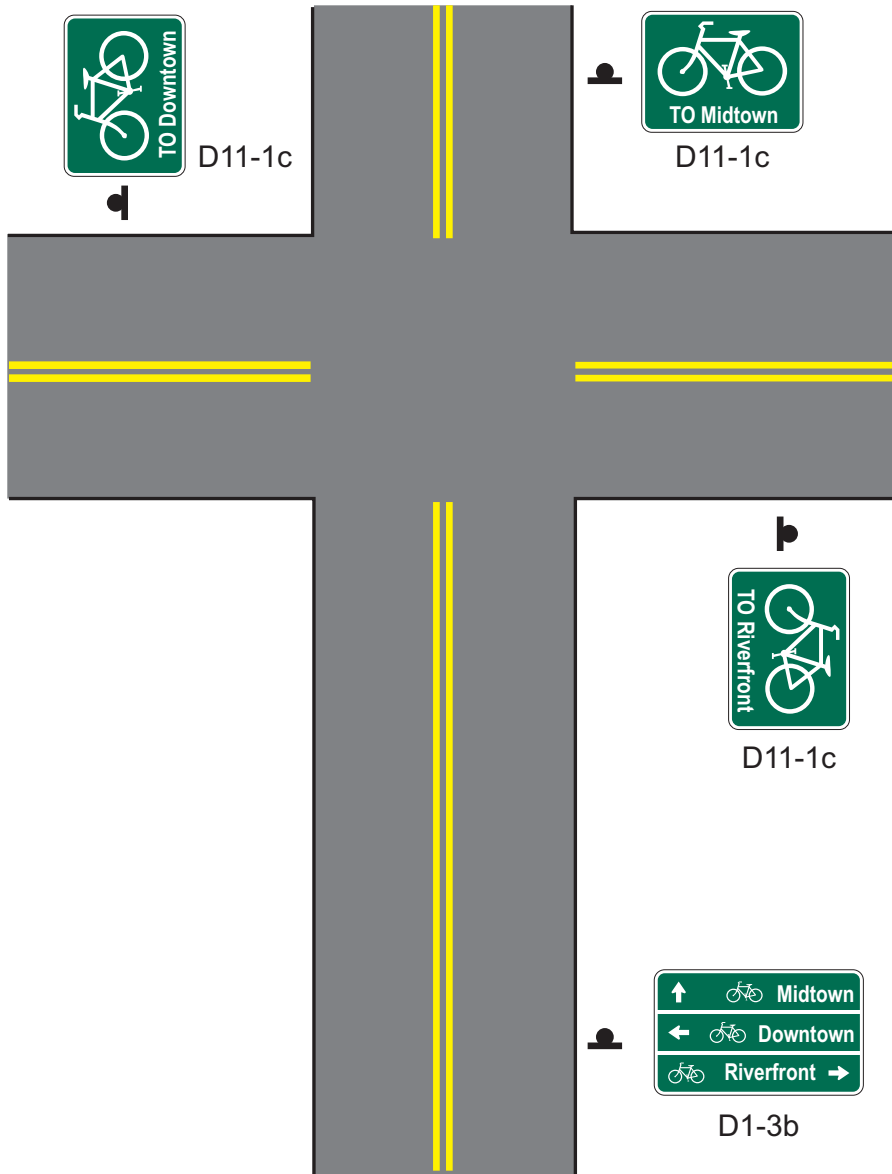

Figure 4-27. Typical Bicycle Guide Signage Layout

4.12 OTHER ROADWAY DESIGN CONSIDERATIONS

4.12.1 Railroad Grade Crossings

Railroad tracks that cross roads or shared use paths on a diagonal can cause steering difficulties for bicyclists. Depending on the angle of the crossing, the width and depth of the flangeway opening, and pavement unevenness, a bicycle wheel may be turned from its course. The height of the track relative to the road is also important. If the track is too low, a bicycle wheel can be “pinched” or deformed, increasing the likelihood of a flat tire, wheel damage, or loss of control by the bicyclist. By improving track placement, surface quality, and flangeway opening width, the angle may be less critical. The following is a more detailed discussion of these issues.

Crossing Angle

The bikeways shown in Figures 4-28 and 4-29 are short independent alignments that continue bike lanes immediately adjacent at either end and, therefore, need not be considered as shared use paths. The likelihood of a fall is kept to a minimum where the roadway or shared use path crosses the tracks at 90 degrees. The preferable skew angle between the centerline of the tracks and the bikeway is between 60 and 90 degrees, so bicyclists can avoid catching their wheels in the flange and losing their balance (see Figures 4-28 and 4-29).

Efforts to create a right-angle crossing at a severe skew can have unintended consequences, as the reversing curves needed for a right-angle approach can create other concerns for bicyclists. It is often best to widen the roadway, shoulder, or bike lane to allow bicyclists to choose the path that suits their needs the best. On extremely skewed crossings (30 degrees or less), it may be impracticable to widen the shoulders enough to allow for 90 degree crossing; widening to allow 60 degree crossing or better is often sufficient. It may also be helpful to post a W10-1 or W10-12 warning sign at these locations.

Crossing Surfaces

The four most common materials used at railroad crossings are concrete, rubber, asphalt, and timber. Concrete performs best, even under wet conditions, as it provides the smoothest ride. Rubber crossings are quite rideable when new, but they are slippery when wet and degrade over time. Asphalt is smooth when first laid, but can heave over time and needs maintenance to prevent a buildup next to the tracks. Timber wears down rapidly and is slippery when wet.

Bikeway Width

The minimum width for a shoulder bikeway as shown in Figure 4-28 should be 6 ft (1.8 m).

Flange Opening

The flangeway opening between the rail and the roadway surface can catch a bicycle wheel, causing the rider to fall. Flange width should be minimized when practical. Light rail and trolley lines need only a narrow flange, whereas heavy rail needs a wider flange. There are flangeway filler products that can be used on heavy rail lines with occasional low-speed rail traffic, such as on spur lines. These rubber fillers are depressed by the rail wheels as they ride over the filler; the filler rises again after the train has passed by to keep the flangeway opening limited. Design and traffic control for bicycle facilities at railroad grade crossings should be coordinated with the responsible railroad company.

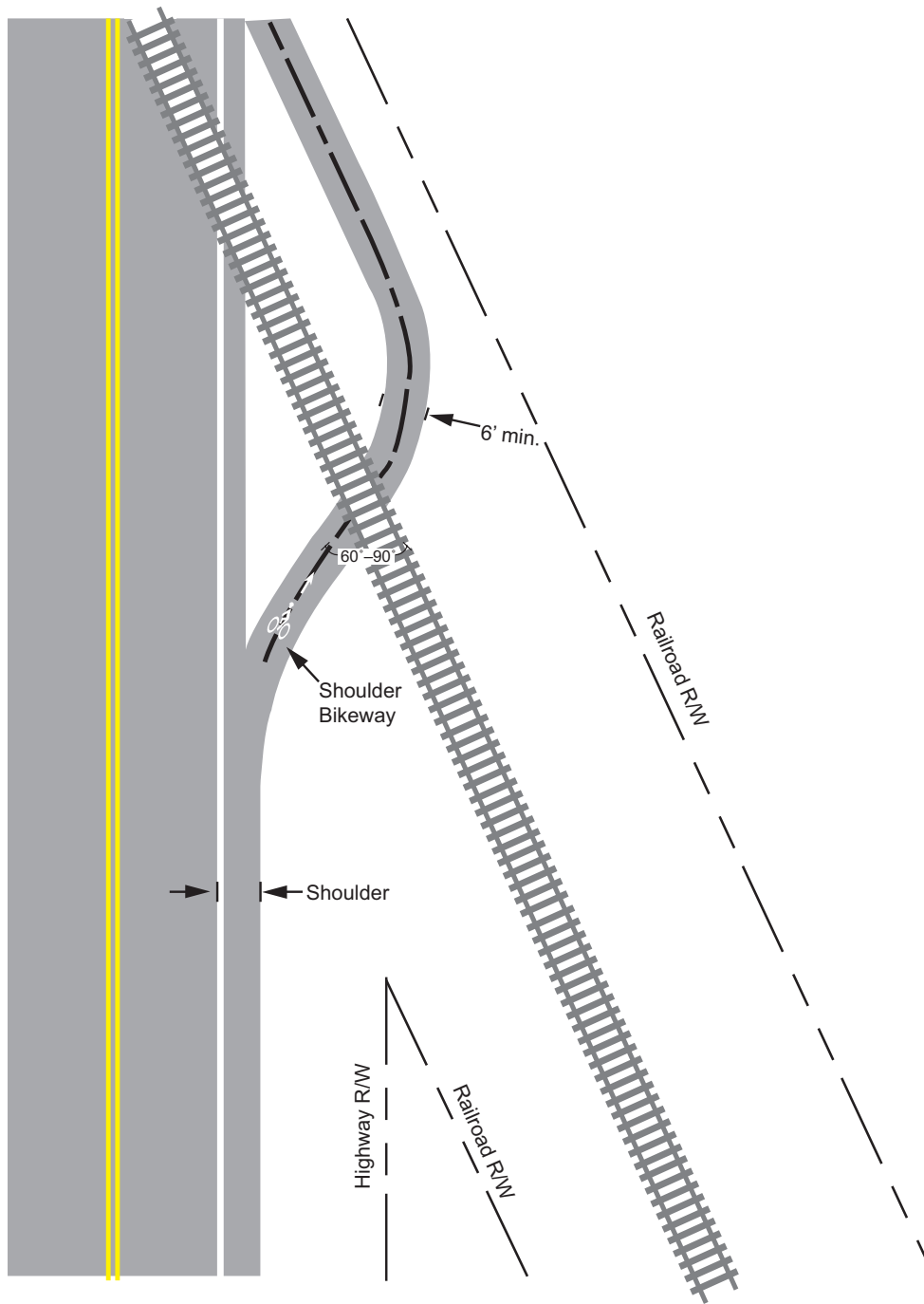

Figure 4-28. Correction for Skewed Railroad Grade Crossing—Separate Pathway

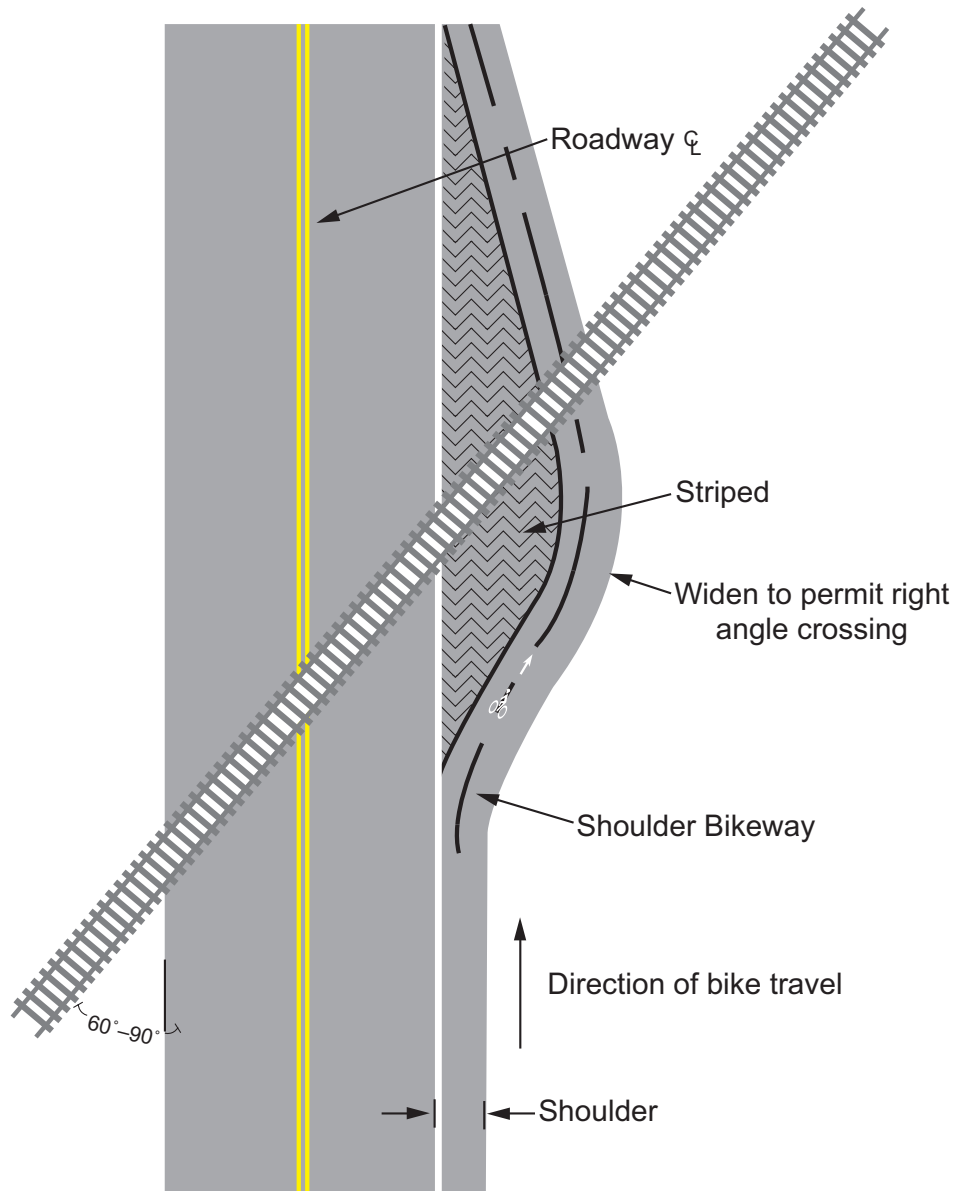
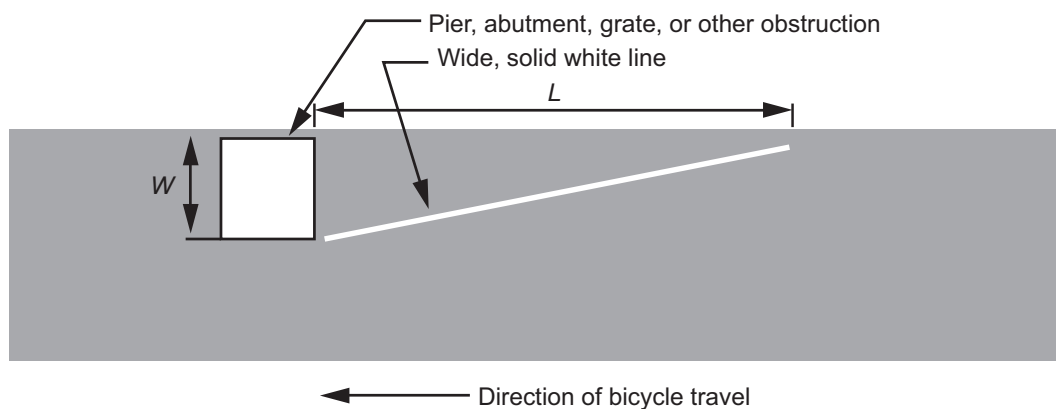

Figure 4-29. Correction for Skewed Railroad Grade Crossing—Widened Shoulder

4.12.2. Obstruction Markings

Barriers and obstructions, such as abutments, piers, rough grates, and other features constricting a bikeway should be clearly marked to gain the attention of approaching bicyclists. This treatment should be used only where the obstruction is unavoidable, and should not substitute for good bikeway design; removing the obstruction is preferred. An example of an obstruction marking is shown in Figure 4-30. Table 4-1 provides the equation for determining the taper length based on MUTCD criteria (3). Table 3-2 presents typical bicycle approach speeds for use in this equation. Signs, reflectors, diagonal yellow markings, or other treatments from MUTCD Part 9 (3) may also be appropriate to alert bicyclists to potential obstructions.



For metric units:
 $L = 0.62WS$, where S is bicycle approach speed in kilometers per hour

For English units:
 $L = WS$, where S is bicycle approach speed in miles per hour

Figure 4-30. Obstruction Marking

Table 4-1. Formula for Determining Taper Length for Obstruction Markings

U.S. Customary			Metric		
$L = WS$			$L = 0.62WS$		
where:			where:		
L	=	taper length (ft)	L	=	taper length (m)
W	=	offset width (ft)	W	=	offset width (m)
S	=	bicycle approach speed (mph)	S	=	bicycle approach speed (km/h)

Note: An additional 1 ft (0.3 m) of offset should be provided for a raised obstruction.

4.12.3 Bridges, Viaducts, and Tunnels

Bridges, viaducts, and tunnels should accommodate bicycles. As a general exception, these structures do not need to accommodate bicycles on roadways where bicycle access is prohibited. However, there are numerous examples of limited access highway bridges that cross major barriers (such as wide waterways) that incorporate a shared use path for bicyclists and pedestrians.

The type of bicycle accommodation should be determined in consideration of the road function, length of the bridge or tunnel (i.e., potential need for disabled vehicle storage), and the design of the approach roadway. The absence of a bicycle accommodation on the approach roadway should not prevent the accommodation of bicyclists on the bridge or tunnel. Shoulder improvements associated with bridge projects (approach shoulders) should include bicycle accommodations, such as paved shoulders or bike lanes.

The most common types of bicycle facilities that are provided on bridges and inside tunnels are bike lanes in urban and suburban areas, and shoulders in rural locations. In most cases (except for those cited below), the bicycle facility will be separated from the pedestrian facility (sidewalk).

In cases where a bridge on a controlled access freeway affects a non-controlled access roadway (e.g., an overpass/underpass that serves as existing surface roadway), the project should include appropriate access for bicycles on the non-limited access roadway, including such elements as bike lanes, paved shoulders, and bicycle crossings at associated ramps.

In locations where bicyclists will operate in close proximity to bridge railings or barriers, the railing or barrier should be a minimum of 42 in. (1.05 m) high. On bridges where bicycle speeds are likely to be high (such as on a downgrade), and where a bicyclist could impact a barrier at a 25 degree angle or greater (such as on a curve), a higher 48-in. (1.2-m) railing may be considered. Where a barrier is less than 42 in. (1.2 m) high, an aluminum rail with posts is usually mounted on top of the barrier. If the shoulder is sufficiently wide so that a bicyclist does not operate in close proximity to the rail, lower rail heights are acceptable.

Long Bridges

Long bridges often have higher motor vehicle speeds than their approach roadways. On bridges with a continuous span over 0.5 mi (0.8 km) in length and design speeds that exceed 45 mph (70 km/h), consideration should be given to providing a shared use path separated from traffic with a concrete barrier, preferably on both sides of the bridge. The provision of a pathway on one side tends to result in wrong-way travel on the departures when bicyclists continue on the same side of the road for some distance. If a pathway is only provided on one side, crossing provisions (grade separated, where needed) should be provided on each end of the bridge to allow bicyclists traveling against the flow of traffic to cross over to the other side of the roadway and proceed in a legal manner. See Section 5.2.10 for information on the appropriate widths of bridges and underpasses.

Retrofits to Existing Bridges and Tunnels

At existing bridges and viaducts, there are often sudden changes in roadway geometry that can significantly reduce travel lane widths and negatively affect bicyclists' comfort for the length of the bridge span.

The preferred solution is to continue to enable bicyclist operation (riding with traffic) on the bridge or viaduct with shoulders or bike lanes by narrowing travel lanes where practical. Where the deck of a bridge is too narrow to accommodate shoulder widths useful for bicyclists, it may be feasible to widen a sidewalk to a shared use path width, e.g., by reducing travel lane widths or installing a cantilever structure. In both cases, the weight increase must be compatible with the structural sufficiency of the bridge. A ramp between the roadway and the sidewalk is needed at either end of the bridge.

Retrofit options for tunnels include widening an existing sidewalk, or eliminating a narrow sidewalk. The latter may not be practical where the sidewalk functions as a barrier curb to discourage large vehicles from traveling too close to the side, or where it is intended for emergency access or egress. In narrow tunnels where bicyclists share travel lanes with motor vehicles, one option is to provide a warning sign and beacon at the tunnel entrance that can be activated by bicyclists. The beacon should be designed to flash for the length of time that it will take for a typical bicyclist to travel through the tunnel, to signal to a motorist that a bicyclist is present. Alternatively, a regulatory R4-11 sign ("BICYCLES MAY USE FULL LANE") may be provided without a beacon.

Adequate lighting is particularly important in these locations so that motorists can see and react to bicyclists using the tunnel.

The installation of shared-lane markings informs bicyclists of where they should position themselves within the shared lane and may serve to remind motorists of the possible presence of bicycle on bridges or in tunnels.

4.12.4 Traffic Signals

Traffic signals assign right of way to various traffic movements at intersections. Traditionally, signal design has been determined by the operating characteristics of motor vehicles. Bicyclists typically use the same travelled way and signal displays as motorists. Bicyclists, however, have significantly different operating characteristics; and it is, therefore, advisable to adjust signal operations for bicyclists. Although non-motorized users of various types may cross at an intersection, this section addresses only the needs of bicyclists.

Signal Considerations for Bicyclists

The differences in operating characteristics of bicyclists have an impact on some signal design elements. Important factors to consider are the speeds and behaviors of bicyclists. Experienced bicyclists on higher classification roadways (major streets) are typically comfortable entering intersections in the mid-to-late green due to longer greens available for major thoroughfares. However, bicyclists on cross streets tend to slow down approaching the intersection even when approaching on a green, in order to start at the beginning of green. Most bicyclists tend to stop at the onset of yellow in the traffic signal. Youth bicyclists often use crosswalks and pedestrian push buttons to cross; therefore, these facilities should be accessible to bicyclists who may wish to proceed through the intersection in this manner. These behaviors and preferences have an impact on the selection of signal timing parameters suitable for bicyclists. It is, therefore, important to evaluate bicyclist needs at a traffic signal by considering the scenarios of a stopped bicycle and a rolling bicycle.

The signal parameters that should be modified to accommodate bicyclists, when appropriate, are the minimum green interval, all-red interval, and extension time:

- Minimum green is intended to effectively clear a vehicle through the intersection from a stopped position. Bicycles need a longer minimum green than automobiles. Some controllers have a bicycle minimum green parameter which can be used with appropriate detection to service bicyclists.
- The all-red interval is used to provide time for crossing automobiles and bicyclists to approach or pass beyond the far side of an intersection.
- Extension time or passage time is the time a detected automobile or bicyclist needs to extend the green indication to provide enough time to clear the intersection before a green indication is displayed to conflicting traffic.

The yellow interval is based on the approach speed of the automobiles and is usually between 3 and 6 seconds in duration. Generally, yellow change intervals calculated for automobiles using commonly accepted formulas are adequate for bicycles.

In some instances, it may be appropriate to indicate that a signal head is intended for the exclusive use of bicyclists. A sign can be added near the signal head that states “BICYCLE SIGNAL”.

This may be appropriate where bicyclists share a signal phase with pedestrians or have their own phase. It may also be appropriate at some path crossings of roadways.

Stopped Bicyclist

When an approach receives a green indication, a stopped bicyclist needs enough time to react, accelerate, and cross the intersection before traffic on the crossing roadway enters the intersection on its green. This is referred to as standing bicycle crossing time, and is used to determine the bicycle minimum green (BMG) time. Intersection crossing time for a bicyclist who starts from a stop and attains crossing speed V within the intersection is shown in Table 4-2.

Table 4-2. Standing Bicycle Crossing Time

U.S. Customary			Metric		
$BCT_{standing} = PRT + \frac{V}{2\alpha} + \frac{(W+L)}{V}$			$BCT_{standing} = PRT + \frac{V}{2\alpha} + \frac{(W+L)}{V}$		
where:			where:		
$BCT_{standing}$	=	bicycle crossing time (s)	$BCT_{standing}$	=	bicycle crossing time (s)
W	=	intersection width (ft)	W	=	intersection width (m)
L	=	typical bicycle length = 6 ft (see Chapter 3 for other design users)	L	=	typical bicycle length = 1.8 m (see Chapter 3 for other design users)
V	=	attained bicycle crossing speed (ft/s)	V	=	attained bicycle crossing speed (m/s)
PRT	=	perception reaction time = 1 s	PRT	=	perception reaction time = 1 s
α	=	bicycle acceleration (1.5 ft/s ²)	α	=	bicycle acceleration (0.5 m/s ²)

Most bicyclists can accelerate at a rate of at least 1.5 ft/s² (0.5 m/s²) and can obtain a speed of at least 10 mph (14.7 ft/s) [16 km/h (4.5 m/s)]. Youth bicyclists often have slower reaction times and need additional time to get started and accelerate. Extended crossing times should be considered where young riders are expected (e.g., near schools).

Bicyclists who begin crossing an intersection from a standing start on a new green take more time to cross than rolling bicyclists who enter on green, since they have to accelerate. This time is usually more critical for bicyclists on minor road approaches, since minor-road crossing distance is ordinarily greater than major-road crossing distance. Bicycle minimum green is determined using the bicycle crossing time for standing bicycles and clearance time as shown in Table 4-3.

Some controllers have a built-in feature to specify and program a bicycle minimum green. If appropriate bicycle detection exists, and a bicycle is detected stopped at the intersection, the controller will provide the bicycle minimum green instead of the normal minimum green. If this type of controller is not used, and if the minimum green needed for local bicyclists is greater than what would otherwise be used, minimum green time should be increased. However, as with all calculated signal timing, field observations should be undertaken prior to making any adjustments.

Table 4-3. Bicycle Minimum Green Time Using Standing Bicycle Crossing Time

U.S. Customary			Metric		
$BMG = BCT_{standing} - Y - R_{clear}$ $BMG = PRT + \frac{V}{2\alpha} + \frac{W+L}{V} - Y - R_{clear}$			$BMG = BCT_{standing} - Y - R_{clear}$ $BMG = PRT + \frac{V}{2\alpha} + \frac{W+L}{V} - Y - R_{clear}$		
where:			where:		
BMG	=	bicycle minimum green time (s)	BMG	=	bicycle minimum green time (s)
$BCT_{standing}$	=	bicycle crossing time (s)	$BCT_{standing}$	=	bicycle crossing time (s)
Y	=	yellow change interval (s)	Y	=	yellow change interval (s)
R_{clear}	=	all-red (s)	R_{clear}	=	all-red (s)
W	=	intersection width (ft)	W	=	intersection width (m)
L	=	typical bicycle length = 6 ft (see Chapter 3 for other design users)	L	=	typical bicycle length = 1.8 m (see Chapter 3 for other design users)
V	=	bicycle speed crossing an intersection (ft/s)	V	=	bicycle speed crossing an intersection (m/s)
PRT	=	perception reaction time = 1 s	PRT	=	perception reaction time = 1 s
α	=	bicycle acceleration (1.5 ft/s ²)	α	=	bicycle acceleration (0.5 m/s ²)

Rolling Bicyclist

Rolling bicycle crossing time determines the adequacy of any red clearance interval and any extension time, if provided. Although a small percentage of adult bicyclists travel at speeds below 10 mph (14.7 ft/s) [16 km/h (4.5 m/s)], most bicyclists momentarily can and do achieve higher speeds. Under typical conditions, the speed (V) can be assumed to be at least this great. If the approach is on an appreciable upgrade or downgrade, a modified value may be appropriate.

When estimating whether adequate time is available for a rolling bicycle to cross the intersection at the end of a green indication, the braking distance and the width of the intersection should be considered. Towards the end of a green indication, beyond a certain point on the approach to the intersection, the bicyclist can neither stop comfortably prior to the intersection nor clear the intersection if clearance time is inadequate. A bicyclist needs some distance to brake and stop comfortably. This distance depends on the bicyclist's speed, perception reaction time, and deceleration rates. The equation for rolling bicycle crossing time considering braking distance is shown in Table 4-4.

Table 4-4. Rolling Bicycle Crossing Time Considering Braking Distance

U.S. Customary			Metric		
$BCT_{rolling} = \frac{BD + W + L}{V}$ $BD = PRT \times V + \frac{V^2}{2\alpha}$			$BCT_{rolling} = \frac{BD + W + L}{V}$ $BD = PRT \times V + \frac{V^2}{2\alpha}$		
where:			where:		
$BCT_{rolling}$	=	bicycle crossing time (s)	$BCT_{rolling}$	=	bicycle crossing time (s)
W	=	intersection width (ft)	W	=	intersection width (m)
L	=	typical bicycle length = 6 ft (see Chapter 3 for other design users)	L	=	typical bicycle length = 1.8 (see Chapter 3 for other design users)
V	=	bicycle speed crossing an intersection (ft/s)	V	=	bicycle speed crossing an intersection (m/s)
BD	=	breaking distance (ft)	BD	=	breaking distance (m)
PRT	=	perception reaction time = 1 s	PRT	=	perception reaction time = 1 s
α	=	deceleration rate for wet pavement = 5 ft/s ²	α	=	deceleration rate for wet pavement = 1.5 m/s ²

A signal should provide sufficient time for a rolling bicyclist who enters at the end of the green interval to clear the intersection before traffic on a crossing approach receives a green indication. The time available for bicyclists to cross the intersection is composed of the yellow change interval, all-red interval, and any extension time, if provided. (Extension time is time added to the duration of a signal phase based on the volume of traffic detected.) As previously stated, the yellow interval is based on the approach speeds of automobiles, and therefore should not be adjusted in order to accommodate bicycles. However, it may be feasible to increase the all-red interval. The time should be increased, where appropriate, up to the longest interval used in local practice. Table 4-5 shows the equation used to determine the all-red interval and extension time needed for the rolling bicycle crossing time.

If time for bicycle crossing is inadequate with maximum red clearance time, use of adaptive signal timing for bicycles may be helpful. This technique extends green time when a bicycle approaching late on green is detected. Traffic engineers typically use extension time and call features within traffic signal controllers; however, the extension setting can also be applied within a specific detector. An extension setting for a phase within a traffic signal controller will extend the green time for vehicles that actuate any detector that feeds the respective phase. However, an extension setting applied within a specific detector will extend the green time only for actuations on that detector. Therefore, when using an exclusive bicycle detector, it is recommended to use the extend feature in the bicycle detector settings instead of the extension settings in the traffic signal controller.

Loop detectors cannot distinguish between bicycles and motor vehicles. Therefore, in locations utilizing loop detectors and extension time, a bike lane is typically needed on the approach in order to provide a location where bicycles (and not automobiles) are detected. In the absence of bike lanes, it may still be feasible to use video detection to distinguish approaching bicyclists. The

braking distance mentioned earlier can also be used to help determine the location of the bicycle detector so that adequate distance is provided for a bicyclist to stop prior to the intersection if they do not reach the detector just before the end of the green interval. Detection for bicycles at signals is discussed in the following section.

Table 4-5. All-Red and Extension Time Using Rolling Bicycle Crossing Time

U.S. Customary			Metric		
$BCT_{rolling} \leq T_{extension} + Y + R_{clear}$			$BCT_{rolling} \leq T_{extension} + Y + R_{clear}$		
where:			where:		
$BCT_{rolling}$	=	bicycle crossing time (s)	$BCT_{rolling}$	=	bicycle crossing time (s)
$T_{extension}$	=	extension time (s)	$T_{extension}$	=	extension time (s)
Y	=	yellow change interval (s)	Y	=	yellow change interval (s)
R_{clear}	=	all-red (s)	R_{clear}	=	all-red (s)

4.12.5 Detection for Bicycles at Traffic Signals

Actuated traffic signals should detect bicycles; otherwise, a bicyclist may be unable to call a green signal and may be forced to break the law by violating a red signal. Various technologies are available for detecting bicycles, including inductive loops, microwave, video, magnetometers, and pushbuttons.

Inductive Loops

The metal rims of a bicycle intercept the horizontal magnetic field above an inductive loop. Diagonal quadrupole inductive loops, such as illustrated in Figure 4-31 have some horizontal magnetic field everywhere within the loop and thus are suitable for detecting bicycles. Other types of inductive loops, such as the conventional quadrupole loop illustrated in Figure 4-32, have a horizontal magnetic field only above the loop slots and are thus generally unsuitable for bicycle detection, particularly at new installations. For existing installations of conventional loops, the MUTCD contains a bicycle detector symbol (see Figure 4-33) as a way of showing bicyclists the location of the loop slot. This pavement marking can be supplemented by a R10-22 sign (see Figure 4-34) to reinforce the message to the bicyclist.

A diagonal quadrupole loop can be used on shared use paths and bike lanes, as well as in travel lanes on roadways. A diagonal quadrupole loop is particularly effective at rejecting vehicles in the adjacent travel lane, allowing the use of a higher sensitivity setting on the detector amplifier.

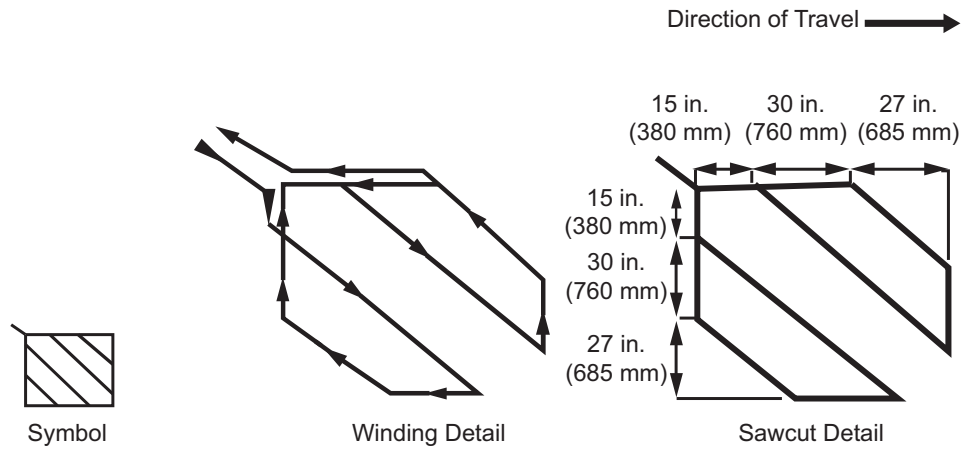

Figure 4-31. Diagonal Quadrupole Loop Detector

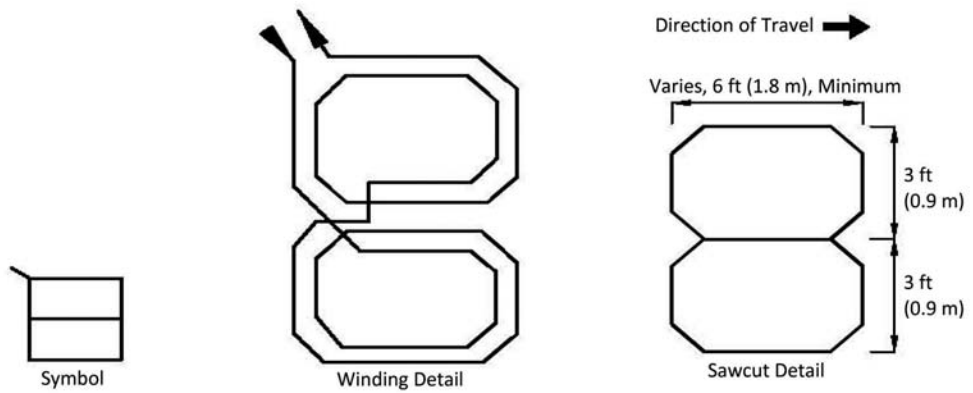

Figure 4-32. Conventional Quadrupole Loop Detector

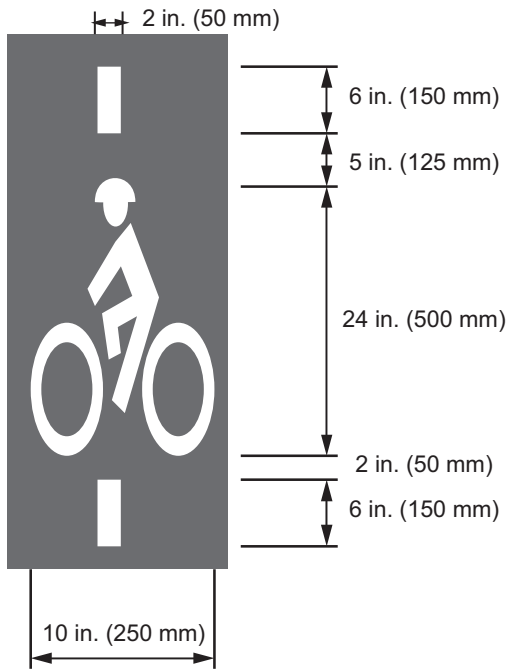

Figure 4-33. Typical Bicycle Detector Pavement Marking

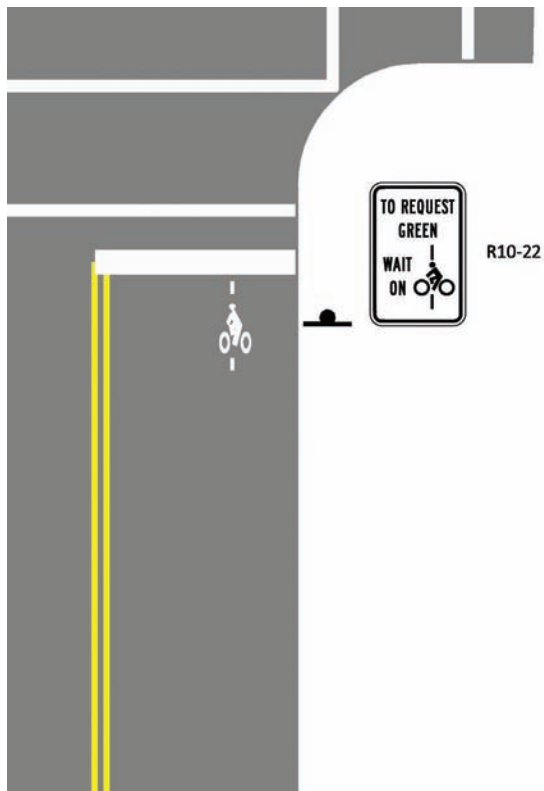

Figure 4-34. Bicycle Detector Pavement Marking and Sign

Video Detection Systems

Video detection uses a processor to analyze the video image from a video camera installed either on a signal mast arm or on a pole at the intersection. This processor analyzes the image in zones drawn by the operator on a monitor. When a vehicle enters the zone, the change in the image is detected and a call is placed to the traffic signal controller. Video detection can be used to detect both moving and stationary objects. Even though some video detectors have problems detecting vehicles, including bicycles, during poor lighting and weather conditions, many agencies continue to use video detection for ease of installation and maintenance, and flexibility in configuration.

Microwave (Radar) Detection Systems

Microwave detection uses a processor to analyze the reflections from a radar transmitter/receiver installed either on a signal mast arm or on a pole at the intersection. This processor analyzes the reflections in zones drawn by the operator on a monitor. When a vehicle or person enters the zone, the change in the reflection is detected and a call is placed to the traffic signal controller. Microwave detection can be used to detect both moving and stationary objects.

Magnetometer Detection Systems

Magnetometer detection uses a processor to analyze the changes produced in the Earth's magnetic field by ferromagnetic material near a magnetometer installed in the pavement. Modern bicycles, however, contain little ferromagnetic material and what ferromagnetic material they do contain is located too far from the pavement to be detected by a magnetometer, so magnetometer detection systems are unsuitable for bicycle detection.

Bicycle Pushbuttons

Bicycle pushbuttons require bicyclists to stop near them and thus are unsuitable as primary detectors on roadways. Bicycle pushbuttons may be used on shared use paths and as a supplement on roadways.

Location of Detection Zones

Bicycle detectors should be located in the expected path of bicyclists. On roadways, bicycle detectors should at least extend across most of the width of the lane. On shared use paths, a bicycle detector should either be located across the width of the lane or within easy reach of a stopped bicyclist.

It may be desirable to install advance bicycle detection, similar to advance vehicle detection. Where it is installed, advance detection makes it possible to minimize delay to bicyclists and provide green extension time by installing one small area detection zone about 100 ft (30 m) from the stop bar, with a second, perhaps larger detection zone located at the stop bar (7). The upstream detector should be located far enough from the intersection to allow for the bicycle stopping distance. Another key consideration in the location of the upstream detector is to avoid being triggered by right-turning vehicles. Both the advance and stop bar detectors must be capable of detecting bicycles. When a bicycle is detected at the upstream loop, appropriate extension time is provided to hold the green to allow the bicycle to reach the loop at the stop bar.

Bicyclist Signal Timing

A bicyclist stopped at the stop bar when the signal turns green should be given enough time to cross the intersection before the signal for the next conflicting movement turns green. This can be achieved either by providing minimum green, plus yellow, plus all-red at least sufficient for

a bicyclist initial start-up time of 6 seconds and a final crossing speed of 10 mph (16 km/h) or with a detection system that prevents the next conflicting movement from turning green until the bicyclist has cleared the intersection.

Maintenance of Traffic Detectors

Maintenance of traffic detectors is discussed in Section 7.2.5.

4.12.6 Bicycles and Traffic Calming

Traffic calming measures are intended to lessen undesirable traffic impacts by restraining traffic speeds. Bicyclists operate at speeds close to what traffic calming aims for; therefore, effective traffic calming will enhance bicycling on local streets. Bicyclists could be considered the “design vehicle” for traffic calming programs and projects; if they work well for bicyclists, they should achieve other stated goals.

Reducing traffic speeds can be accomplished through physical constraints on the roadway, by reducing lateral offsets to roadside objects, or by creating a sense of enclosure on the street corridor. Motorists typically drive at speeds they perceive as safe; this is usually related to the road design, especially available lane and roadway width and the surrounding environment. The following sections discuss individual traffic calming techniques in light of their potential advantages or disadvantages for bicycling. Examples of traffic calming treatments in current use are presented in ITE’s *Traffic Calming State of the Practice: An ITE Informational Report* (6).

Narrow (Very Slow Speed) Streets

Narrow cross-sections can effectively reduce speeds, as most motorists adjust their speed to the available lane width. Narrow streets also reduce construction and long-term maintenance costs. Effective widths for two-way local streets are 26–28 ft (7.9–8.5 m) with parking on both sides, and 20 ft (6.0 m) with parking on one side. These dimensions create “queuing streets,” where oncoming motorists have to wait for the other to pull over into an available space at a driveway or empty parking spot. These dimensions leave enough room for emergency vehicle access, as well as the occasional moving van or large delivery truck.

- Effect on bicycling—positive, if operating speeds are reduced to 20–25 mph (32–40 km/h). Bicyclists simply ride in the lane. This is a strategy that works best on local and residential streets. On busier roads, narrow lanes are less comfortable for bicyclists.

Vertical Deflections

Vertical deflections include speed humps, speed tables, and speed cushions, as well as raised intersections and raised crosswalks. Well-designed vertical deflections allow vehicles to proceed over the device at the intended speed with minimal discomfort, but will jolt the suspensions and occupants of vehicles driven at higher speeds. Speed humps should be designed with a sinusoidal

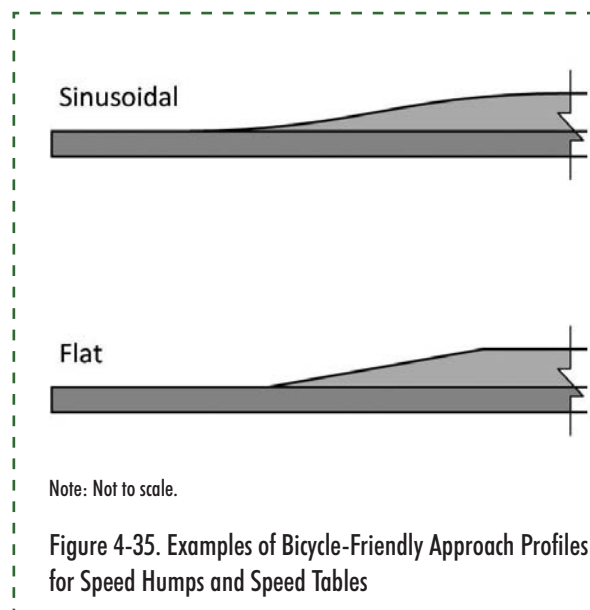

profile, which is easier for bicyclists to traverse at normal bicycling speeds than a flat, parabolic, or circular profile (see Figure 4-35 for a comparison of sinusoidal and flat profiles). The front edge or lip of the device should be as smooth as practical and meet the road with minimal vertical displacement. Except in speed cushion applications, at-grade gaps should not be provided in vertical deflections for bicyclists to pass through, as motorists would take advantage of them, reducing the effectiveness of the feature. To allow drainage in gutters, tapers may be needed to street grade on the edges. Speed cushions, speed tables, raised intersections, and raised crosswalks usually use a flat ramp on each end, and a level area in the middle long enough to accommodate most wheel-bases.

- Effect on bicycling—positive, as they reduce motor vehicle speeds, assuming that a sinusoidal profile is used.

Speed bumps are vertical deflections with heights comparable to speed humps but much shorter traversal lengths (in the range of 1 to 3 ft [0.3 to 0.9 m], typically, in parking area applications). Their use on public roads is unexpected and can result in a serious crash when bicyclists approach them at speed, and fail to notice them in time.

Curb Extensions (Also Known as Chokers, Neckdowns, or Bulbouts)

Chokers constrict the street width to the traveled way minus the width of the nominal on-street parking lane [usually 7 ft (2.1 m)]. They are intended to reduce the pedestrian crossing distance, slow right-turning vehicles, improve visibility between motorists and pedestrians, and provide more space for landscaping and other features. Chokers should be highly visible and should not extend beyond the width of the parking lane into the travel path of a bicyclist. The visibility of curb extensions can be increased with bright paint on the curbs, and vertical elements such as landscaping, benches, trashcans, fire hydrants, and so forth. On busy thoroughfares, where lane lines are striped, a line should be painted between the bike lane and the parking lane to guide bicyclists past the curb extensions (see Figure 4-36).

- Effect on bicycling—positive, as long as the choker/curb extension is highly visible to bicyclists.

Chicanes

By alternating placement of curb extensions (possibly including on-street parking bays or low-growing or narrow landscape features) from one side of the road to the other to establish a serpentine alignment, a chicane reduces the speed of a driver following the curves.

- Effect on bicycling—generally neutral. Care should be taken that bicyclists are not surprised by oncoming drivers, or squeezed by overtaking drivers, where the width of the traveled way and sight lines have been reduced.

Traffic Circles

Traffic circles are a neighborhood traffic calming device for intersections. They are typically 12 to 16 ft (3.7 to 4.9 m) in diameter, and often include low landscaping and mountable curbs so that large vehicles can bypass the circle. They are used to reduce speeds by deflecting traffic at intersections (similar to a chicane) and reducing long vistas so that drivers tend to slow down. Traffic circles and roundabouts are addressed further in Section 4.12.11.

- Effect on bicycling—positive. Traffic circles allow bicyclists to maintain momentum through intersections and are preferable to stop signs, which are often ignored by bicyclists using neighborhood streets.

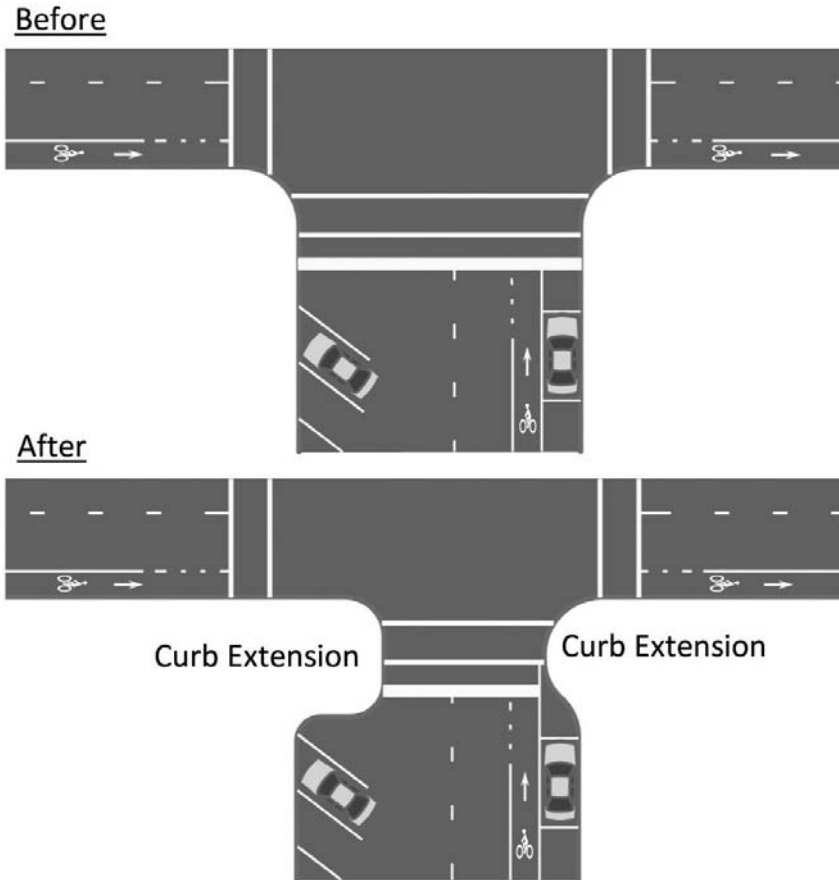

Figure 4-36. Curb Extensions

Creating a Sense of Enclosure

Establishing buildings at the back of the sidewalk, adding decorative pedestrian-scale lamp posts, and planting tall trees at the street edge all help make the roadway appear narrower than it is. Such treatments are most appropriate for very low speed streets.

- Effect on bicycling—positive, as traffic speeds may be reduced with no constraints on bicyclists.

4.12.7 Bicycles and Traffic Management

Traffic management includes the use of traditional traffic control devices to manage volumes and routes of traffic. Traffic management is an area-wide treatment, rather than a solution for a specific street. Traffic management and traffic calming are often complementary, and a plan to retrofit an area often includes a variety of tools from each.

The following measures restrict traffic access to local streets. This may result in some out-of-direction travel for certain trips; however, if combined with a plan to develop a bicycle boulevard, these strategies can improve bicycle access overall.

Multi-Way Stops

Stop signs are not a recommended traffic management technique. All-way stops slow traffic excessively, encourage drivers to accelerate to higher speeds to make up for lost time, increase noise and air pollution, and may increase crashes. All-way stop signs are often ignored where there is no perceived need, breeding disrespect for their legitimate use.

- Effect on bicycling—negative, as bicyclists want to maintain their momentum; they are often reluctant to come to a complete stop due to the added energy needed to regain momentum.

One-Way Chokers

At certain intersections with thoroughfares, motor vehicles are restricted from entering a local two-way street, but are allowed out; drivers must enter from another side street. Bicyclists can be exempted from this restriction. This can be made possible with either a plaque (“EXCEPT BICYCLES”) mounted under a “DO NOT ENTER SIGN” (see Figure 4-37), or by providing a cut-through slot in a physical diverter. Two-way operation resumes immediately past the choker. This is a common strategy used on bicycle boulevards (see Section 4.10), to reduce the amount of motor vehicle traffic along the route.

- Effect on bicycling—positive, as long as exemptions are allowed for bicyclists.

Diverters and Cul-de-Sacs

These configurations separate otherwise adjoining street sections, preventing direct travel between them. Caution should be used when physically restricting access, as this may contradict other transportation goals, such as an open grid system. Cul-de-sacs may include pathways for bicycle and pedestrian access that connect to adjacent streets and/or other cul-de-sacs to form a continuous route.

- Effect on bicycling—positive if access to neighboring streets is provided. The effect on bicycling is negative if through-access is not provided for bicyclists, as this limits bicyclists’ ability to use low-volume local streets, and forces out-of-direction travel on busier thoroughfares.

Note on one-way chokers and diverters: the benefits to bicyclists are realized only if the cut-throughs are well designed and well maintained. The design should allow bicyclists to proceed with minimal change of direction or slowing; they should be in line with their path of travel (on the right side of the roadway, with no sudden turns needed) and wide enough to allow passage for a trailer or adult tricycle, or for two bicyclists, if two-way traffic is accommodated in the cut-through. A cut-through at a one-way choker only needs to accommodate one-way bicycle traffic. Maintenance is equally important; cut-throughs tend to accumulate debris, which should be swept regularly to provide a clear path for bicyclists.

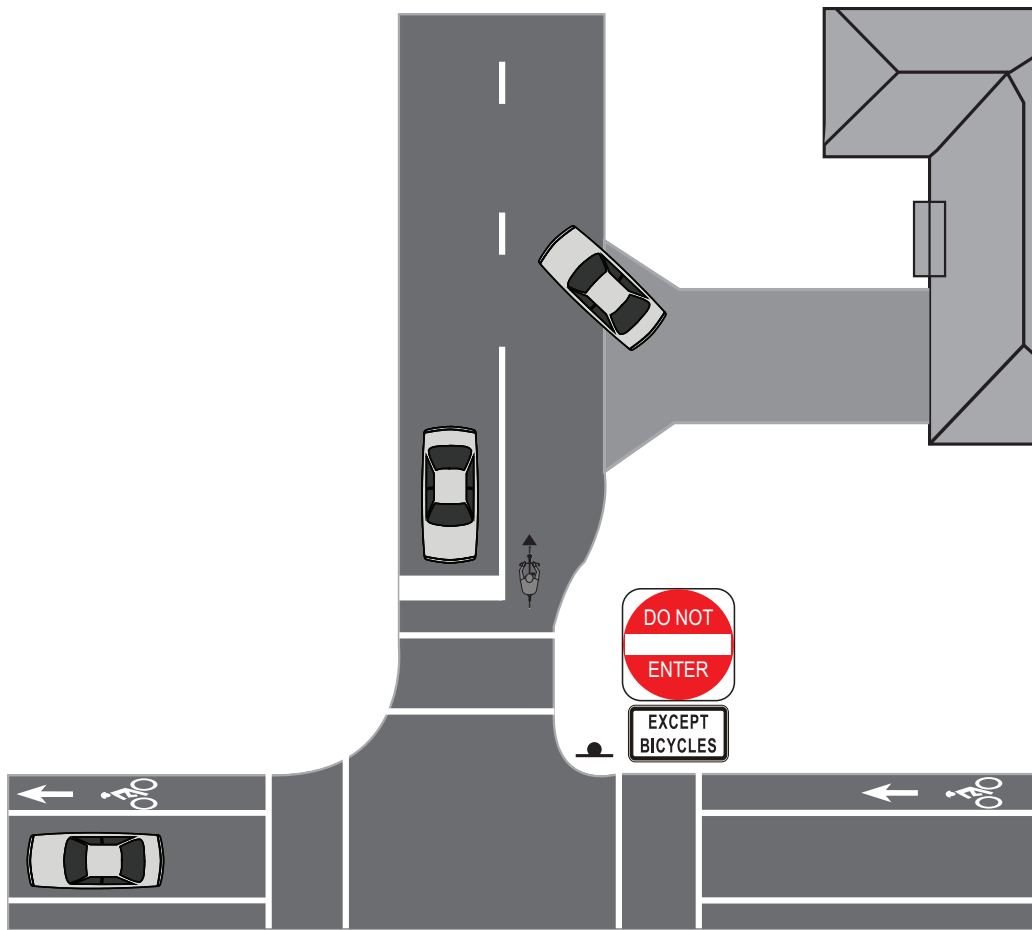

Figure 4-37. Choker with Bicycle Access

4.12.8 Drainage Grates and Utility Covers

Drainage grates with openings running parallel to the curb can cause narrow bicycle wheels to drop into the gaps and cause a severe crash. Care should be taken that drainage grates are bicycle-compatible, with openings small enough to prevent a bicycle wheel from falling into the slots of the grate (Figure 4-38). The gap between the drainage grate and its frame should be 1 in. (25 mm) or less.

Another way to avoid drainage-grate concerns is to eliminate them entirely with the use of inlets in the curb face. More inlets per mile may be needed to handle bypass flow. Another bicycle-friendly option is to place the inlet grate entirely within the gutter of the street, rather than extending it out into the traveled way.

Where bicycle-incompatible grates remain, metal straps can be welded across slots perpendicular to the direction of travel at a maximum longitudinal spacing of 4 in. (100 mm), although care should be taken that the grate does not become a debris collection site. These should be checked periodically to confirm that the straps remain in place. In general, this is only a temporary solution, and the location should ultimately be retrofitted with bicycle-compatible drainage grates.

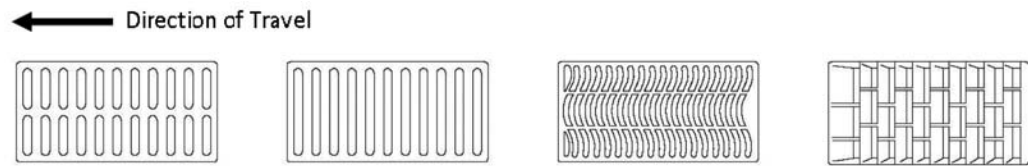

Figure 4-38. Bicycle-Compatible Drainage Grates

Another concern arises when the roadway surface sinks, crumbles, or becomes otherwise unrideable around a drainage grate. Surface grates should be flush with the road surface. Inlets should be raised after a pavement overlay to within 0.25 in. (6 mm) of the new surface. If this is not possible or practical, the pavement should taper into drainage inlets so it does not have an abrupt edge at the inlet. Utility covers present similar concerns and should be installed flush with the adjacent roadway surface.

4.12.9 Bicycle Travel on Freeways

Bicycling on freeways is prohibited in many states. In some states, however, bicycle operation is permitted on freeway shoulders where authorized by maintaining agencies. This is typically done where reasonable alternative routes are unavailable or deemed less suitable for bicycle travel than the freeway. Where freeways are open to bicycle travel, bicyclist usage is usually infrequent. Crash studies have found relatively few crashes involving bicyclists on freeways (6), (8). Where feasible and practical, alternatives can be developed by improving existing routes or providing a shared use path within or adjacent to the freeway right-of-way.

The following factors should be considered in determining the relative suitability of a freeway segment and an alternative route:

- The wind blast effect of high-speed vehicle traffic, particularly large trucks, should be considered. Clear shoulder width (exclusive of rumble strips) should be sufficient to provide adequate separation between bicyclists and high-speed traffic. Bicycle LOS can be helpful in determining the appropriate shoulder width.
- The frequency and design of entrance/exit ramps should be considered. For example, two-lane ramps are difficult for bicyclists to maneuver across. Flyover and left-side ramps can create very difficult conditions for bicyclists, depending upon their configuration. Bicyclists should not have to merge across the through-lanes of a highway to reach an exit.
- Heavy traffic volumes on entrance/exit ramps can make it difficult for bicyclists to cross ramps at certain times of the day.

At an exit beyond which bicyclists are not permitted to continue on a limited-access highway, a sign should be posted to inform bicyclists of the requirement to exit.

4.12.10 Bicycle Travel Through Interchange Areas

Like motorists, bicyclists often have to pass through freeway interchanges to access roads and destinations on the other side of a freeway. In urban and suburban areas, bicyclists of all skill levels travel on arterial and collector streets at freeway interchanges. These interchanges can be significant obstacles to bicycling if they are poorly designed. Travel on the crossroad through some complex interchange designs may be particularly challenging for youth bicyclists.

In rural areas, traffic volumes are usually low, and most recreational and touring bicyclists are experienced enough to make their way through an interchange. Shoulder widths through interchanges should be wide enough for bicycle use.

Basic Design Principles at Freeway Interchanges

It is important to consider both convenience and the potential for crashes when accommodating bicycle travel near interchanges. The issue of potential crashes becomes moot if facilities are not used because of perceived inconvenience. The path bicyclists need to follow should be obvious and logical, minimizing out-of-direction travel and grade changes. The interface between the ramps and the local cross streets should minimize conflicts so that both motorists and bicyclists are aware of merging and crossing locations. Bike lanes or paved shoulders should be provided in both directions.

The key areas for reducing bicycle crashes and increasing bicyclist convenience are at the freeway ramp terminals, where freeway traffic interacts with local traffic and the speed differential between bicyclists and motor vehicles is often great. Designs that encourage high-speed and/or free-flowing traffic movements are the most difficult for bicyclists to negotiate. Designs that are functional for bicycle passage typically encourage slowing or require motor-vehicle traffic to slow or stop.

Bicyclists are best accommodated at interchanges by designing junctions as right-angle intersections (Figure 4-39) or roundabouts. Such designs restrain speeds, minimize conflict areas, and promote visibility. In this way, conflicts between bicyclists and motorists are dealt with in a manner familiar as most urban intersections:

- Motorists exiting the freeway and making a left turn onto the crossroad are controlled by a stop sign or signal.
- Motorists exiting the freeway and making a right turn onto the crossroad are controlled by a stop sign, signal, or yield sign, rather than allowing a free-flowing movement.
- Motorists turning left from the crossroad onto a freeway entrance ramp are controlled by a traffic signal or yield to oncoming traffic, including bicyclists.
- A right-turn lane should be added with a taper for motorists turning right onto the freeway entrance ramp. Where a bike lane is present on the approach, a bike lane continuation should be provided along the left side of the right-turn lane. Since motorists cross the path of bicyclists to enter the right-turn lane, they are required to yield. This treatment can also be helpful where an approach has a paved shoulder, providing for the correct positioning of the bicyclist at interchanges.

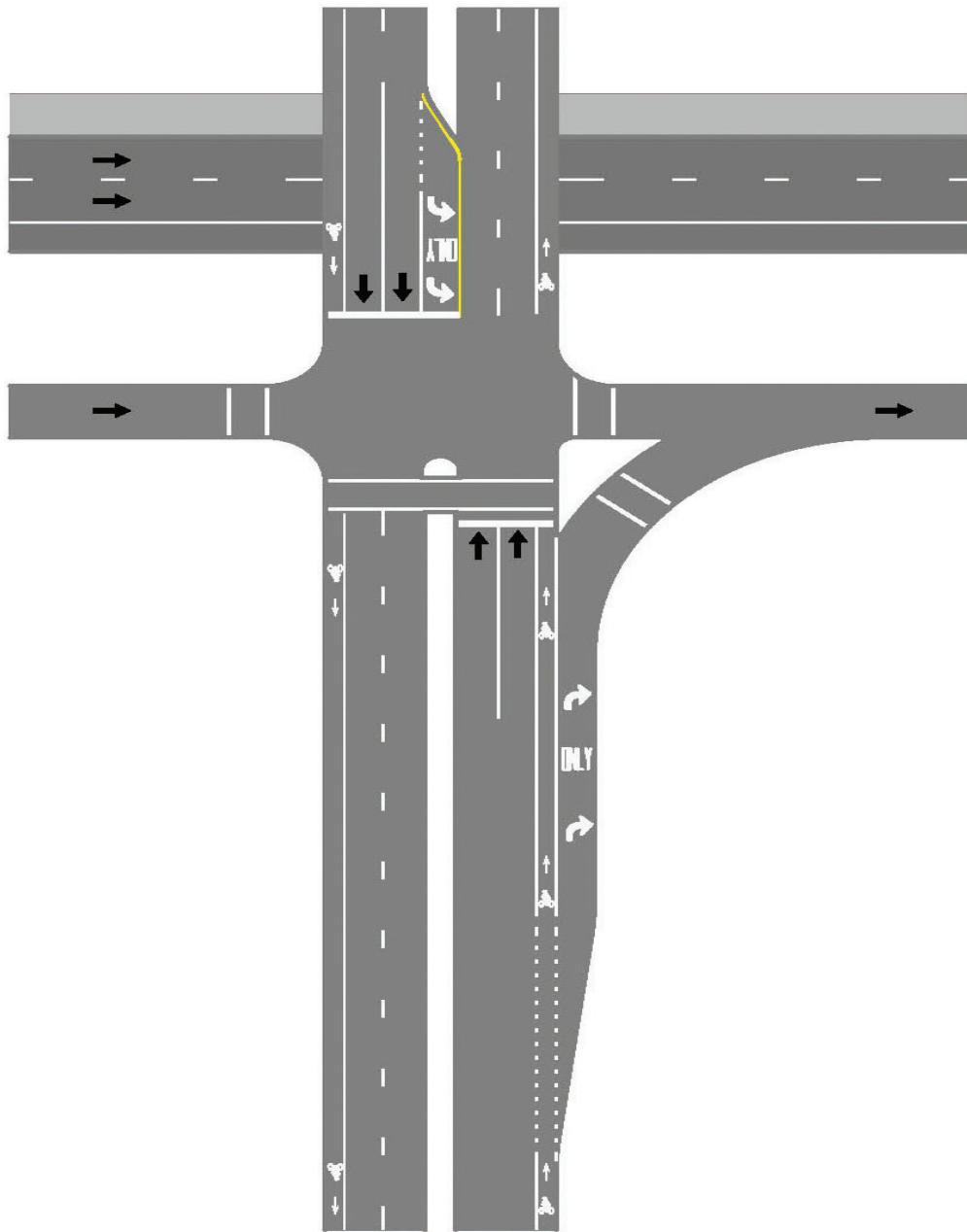

Figure 4-39. Example of Bike Lane on the Crossroad at a Freeway Interchange

Single-Point Diamond Interchange (SPDI)

The single-point diamond interchange (Figure 4-40) is used in urban locations because of the reduced need for right-of-way, its ability to handle high volumes of left-turning traffic, and the potential for improved cross street throughput. SPDIs can be made accessible to bicyclists by following these principles:

- Each vehicular movement should be clearly defined and controlled.
- Exit and entry ramps should be designed at close-to-right angles.
- The right-turning movement off the local arterial onto the freeway should be accommodated by using a standard right-turn lane with a bike lane to the left, encouraging motorists to yield to bicyclists when merging into the right-turn lane.
- Bicyclists should be able to proceed through the intersection in a straight line. Dotted lane lines may be needed to guide bicyclists through wide intersections (see Figure 4-22).
- Careful consideration should be given to the traffic signal timing. The fact that all ramp terminals come to a single, signalized intersection creates a very large intersection, which can make it difficult to provide adequate signal clearance time for bicyclists. To address this concern, the signal phasing order should be as follows:
 1. Through vehicles on the arterial.
 2. Left-turn movements from the arterial to the freeway.
 3. Left-turn movements from the freeway to the arterial.

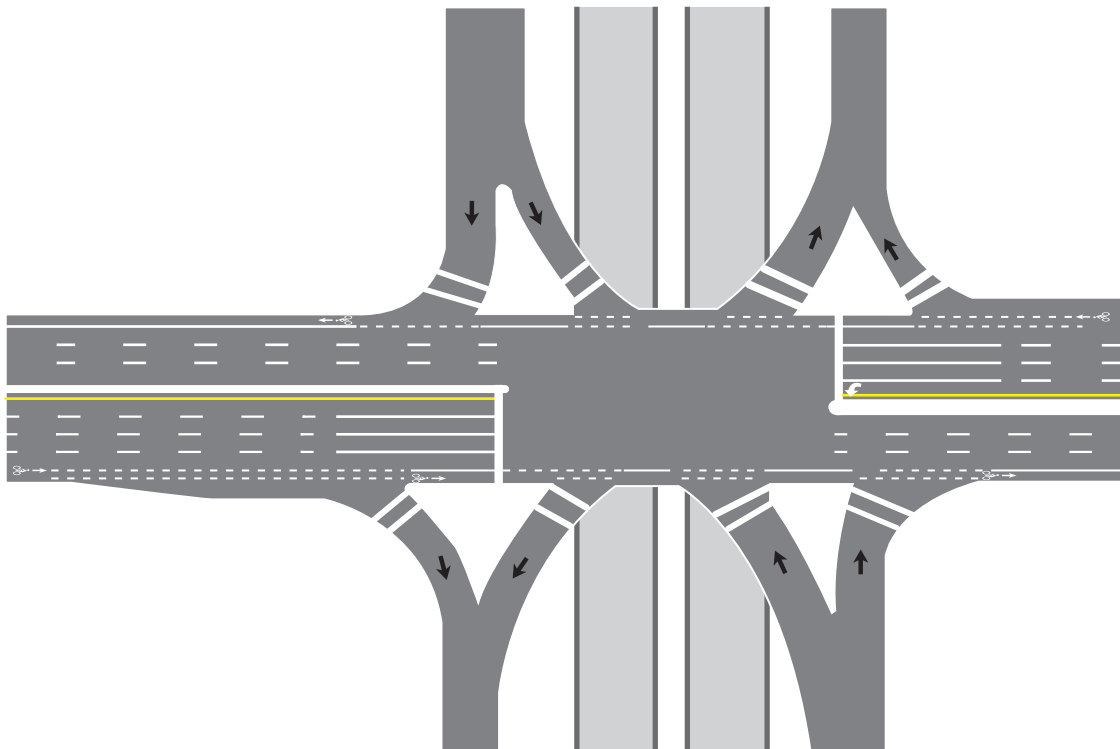

Figure 4-40. Single-Point Diamond Interchange (SPDI)

If the second phase is skipped (e.g., because no vehicle enters one of the left-turn lanes on the crossroad), a through bicyclist might still be passing through the intersection when a green indication is displayed for the left-turn movements from the freeway exit ramps. To allow bicyclists time to clear the conflict area when this happens, use of a longer all-red interval may be needed (see Section 4.12.4 on Traffic Signals).

The SPDI can be designed to work reasonably well for bicyclists if it is the intersection of a local thoroughfare and a freeway; bicyclists need to be accommodated only on the crossroad, but are often not permitted on the freeway. If a SPDI is used for the grade-separated intersection of two surface streets, both of which accommodate bicyclists, then the SPDI design is not effective, as bicyclists on one of the streets will be in a freeway-like environment, with free-flowing exiting and merging ramps.

High-Speed Merge and Free-Flow Turn Lanes

As described above, configurations on arterials with high-speed merges and/or free-flow turn lanes at interchanges are difficult for bicyclists to negotiate and should be discouraged. However, there are many existing interchanges where high-speed merges and free-flow exit lanes are already in use, and there are some situations where these high-speed movements are used to avoid unacceptable levels of delay within the interchange. In addition, bike lanes are sometimes used on urban parkways, which often have freeway-style merging lanes and turn ramps rather than simple intersections. The difficulties for bicyclists created by traffic entering or exiting a roadway at high speeds can be minimized using the designs below.

At some interchanges, it may be appropriate to allow bicyclists the option of using sidewalks, particularly if this will provide access to a signalized crosswalk or other crossing situation that may be more comfortable for some bicyclists. A disadvantage of this approach is that bicyclists riding on sidewalks conflict with pedestrians and may experience other operational difficulties (see Section 5.2.2). If this option is provided, there should be sidewalks on both sides, and they should be wide enough for shared use by bicyclists and pedestrians.

Bicycle Lane Treatment at Merging Ramp Lanes

It is difficult for bicyclists to traverse the undefined area created by right-lane merge movements, because the acute angle of approach reduces visibility, and the speed differential between bicyclists and motorists is high because motor vehicles are accelerating to merge into traffic. There are two approaches to the treatment of bike lanes at such locations:

1. The first option is to simply allow bicyclists to choose their own merge, weave, or crossing maneuvers, as depicted in Figure 4-41. Where the merge area is fairly short (i.e., bicyclists are exposed for less distance), it may be appropriate to continue bike lane or shoulder markings as dotted lines through the merge area, if the ramp configuration is such that merging traffic is at fairly low speeds.
2. Where the merge distance is long and there are exceptionally high volumes of ramp traffic, it may be appropriate to provide a design that guides bicyclists in a manner that provides a short distance across the ramp at close to a right angle, and a crossing in an area where sight lines are good and drivers' attention is not entirely focused on merging with traffic (Figure 4-42). However, this configuration reverses the yielding relationships that would otherwise apply (if a bicyclist continued on a direct path), and can involve delay to bicyclists. Crosswalks should not be used at these locations, because vehicles merging should not be expected to stop here.

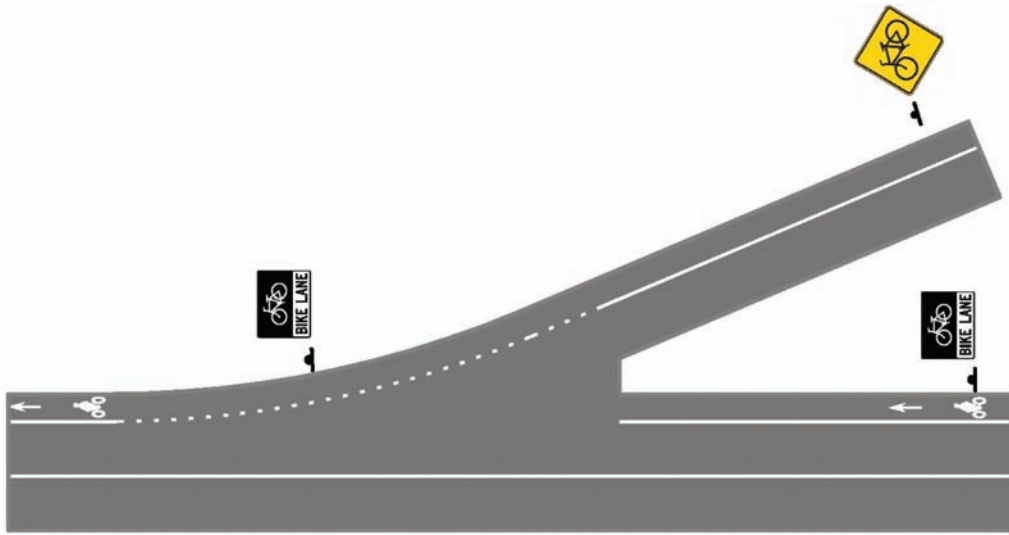

Figure 4-41. Option 1—Bike Lane and Free-Flow Merging Roadway

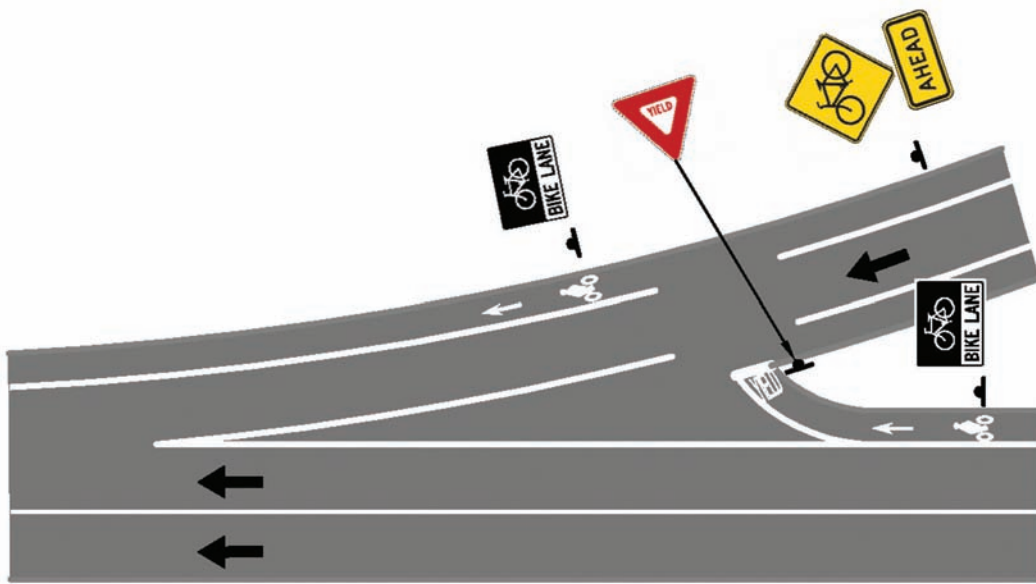

Figure 4-42. Option 2—Bike Lane and Free-Flow Merging Roadway

Bicycle Lane Treatment at Diverging Ramp Lanes

Diverging ramp lanes present difficulties for bicyclists because motorists expect to exit the roadway with little reduction in speed, may fail to signal their maneuver, may pass bicyclists without enough clearance, or may not yield to bicyclists before crossing their path of travel. In addition, bicyclists may misjudge the intent of overtaking drivers who fail to use their turn signals. The best way to accommodate bicyclists at an exit ramp is to develop a right-turn lane prior to the point where the ramp diverges from the roadway, and place the bike lane to the left of the right-turn lane, similar to a right-turn lane configuration at a right-angle intersection (see Figure 4-43). Alternatively, where a ramp diverges from the roadway at a fairly steep angle, a bike lane can be dotted across the diverge area and the “BEGIN RIGHT TURN LANE YIELD TO BIKES” sign (R4-4) placed at the beginning of the diverge area. In cases where motor vehicle speeds are high and sidewalks are present, bicyclists may be given the option to exit onto the sidewalk and to proceed through the interchange along the pedestrian route. However the on-road bike lane should still be provided for bicyclists who prefer to remain on the road. If a roadway lane is dropped (i.e., leads directly to the diverging roadway), a design as shown in Figure 4-21 is appropriate. At a diverging ramp that leads to a freeway, a jughandle design similar to that shown in Figure 4-29 may be provided so that bicyclists may cross the ramp at close to a right angle.

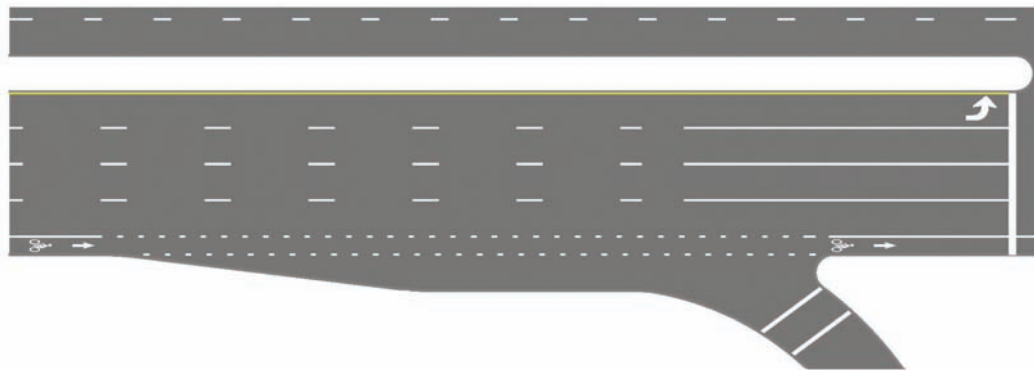

Figure 4-43. Example of Bike Lane and Diverging Roadway on an Arterial Street

Grade-Separated Crossings at Ramps

At especially complex interchanges where conflicts between bicycles and high-speed and free-flow motor vehicle movements are unavoidable, grade separation may be considered. Grade-separated facilities add out-of-direction travel, and will not be used if the added distance is too great. This can create an increased potential for crashes if bicyclists ignore the grade-separated facility and try to negotiate the interchange at grade with no accommodations to facilitate this movement.

Ideally, grade separation is achieved by providing separated paths on both sides of the arterial street that cross over or under the freeway ramps and the freeway itself, so approaching bicyclists from either direction do not have to cross the arterial to continue through the interchange. If a separated path for grade separation is provided on only one side of the interchange, some bicyclists will need to cross the arterial street in order to use the grade separation, and then they need to cross back to continue on the correct side after going through the interchange.

Regardless of whether two paths or one path is used, clear directions should be given to guide bicyclists' movements at interchanges, particularly those that differ from standard bicycle operation. Structures, especially undercrossings, should be convenient and have good visibility so that

they are properly used by bicyclists. Personal security is an important consideration as well, as the grade separation may result in long sections of pathway that cannot be easily accessed in an emergency. Adequate lighting is particularly important at these locations, but may not in itself fully address personal security issues.

Shared use paths at interchanges should be designed to avoid significant grade changes. Opportunities to provide direct links to destinations should be sought if they reduce travel distance compared to the roadway alignment. Grade-separated crossings will also be used by pedestrians, therefore they must meet accessibility standards; see Chapter 5 on “Shared Use Paths” for more information.

4.12.11 Bicycle Travel at Roundabouts

Roundabouts are an increasingly popular design solution for intersections. Single-lane roundabouts can provide significant crash reduction benefits for bicyclists when they are designed with their needs in mind. At roundabouts, some bicyclists will choose to travel on the roadway, while others will choose to travel on the sidewalk. Roundabouts can be designed to simplify this choice for bicyclists.

General Roundabout Design Issues

Since typical on-road bicycle travel speeds are between 10 and 20 mph (15 and 30 km/h), roundabouts that are designed to constrain motor vehicle speeds to similar values should reduce crashes and improve usability for bicyclists. Urban roundabouts should have a maximum entry speed of 20 to 30 mph (30 km/h to 50 km/h); single-lane roundabouts are typically at the lower end of this range. The geometric features of a roundabout (e.g., entry and exit radius, entry and exit width, splitter islands, circulatory roadway width, and inscribed circle diameter) should combine to constrain motor-vehicle speeds (10).

Single-lane roundabouts are much simpler for bicyclists than multilane roundabouts, since bicyclists do not need to change lanes, and motorists are less likely to cut off bicyclists when they exit the roundabout. Therefore, when designing and implementing roundabouts, authorities should avoid implementing multilane roundabouts before their capacity is needed. If “design year” traffic volumes indicate the need for a multilane roundabout, but this need is not likely for several years, the roundabout can be built as a single-lane roundabout, and designed so that additional lanes may be opened in the future when and if traffic volumes increase. In addition, where a roundabout is proposed at an intersection of a major multilane street and a minor street, consideration should be given to building a roundabout with two-lane approaches on the major street and one-lane approaches on minor streets. When compared to roundabouts with two lanes at all four legs, this design can significantly reduce complexity for all users, including bicyclists.

Neighborhood traffic circles are frequently used to provide traffic calming on local streets in urban and suburban neighborhoods. Neighborhood traffic circles are similar in design to roundabouts, but do not typically have an angled entry like that shown in Figure 4-44 to constrain approach speeds of motor vehicles.

Designing for Bicycle Travel Within the Roundabout

In general, bicyclists who have the skills to ride in urban traffic can manage single-lane roundabouts with little difficulty. Where appropriate design speeds are used, bicyclists can comfortably merge into the lane of traffic. Even at multilane roundabouts, many bicyclists will be able to travel through roundabouts in the same manner as other vehicles, particularly during lower volume periods.

Bike lanes should be terminated in advance of roundabouts. The full-width bike lane should normally end 100 ft (30 m) before the edge of the circulatory roadway (see Figure 4-44). Terminating the bike lane cues bicyclists to merge into the lane of traffic. An appropriate taper should be provided to narrow the sum of the travel lane and bike lane widths down to an appropriate entry width for the roundabout. The taper should end prior to the crosswalk at the roundabout, to achieve the shortest practical pedestrian crossing distance. A taper rate of 7:1 is recommended to accommodate a design speed of 20 mph (25 km/h). To taper a 5 to 6 ft- (1.5-to-1.8 m)-wide bike lane, a 40 ft (12 m) taper is recommended. The bike lane line should be dotted for 50 to 200 ft (15 to 60 m) in advance of the taper. A longer dotted line encourages bicyclists to avail themselves of timely gaps to merge into traffic, rather than delay until a point where, if no gap is available at the moment, the only practical alternative is to pause and wait for one. The bike lane line should be terminated at the start of the taper or where the normal bike lane width is no longer available. After the bike lane is terminated, shared-lane markings may be used.

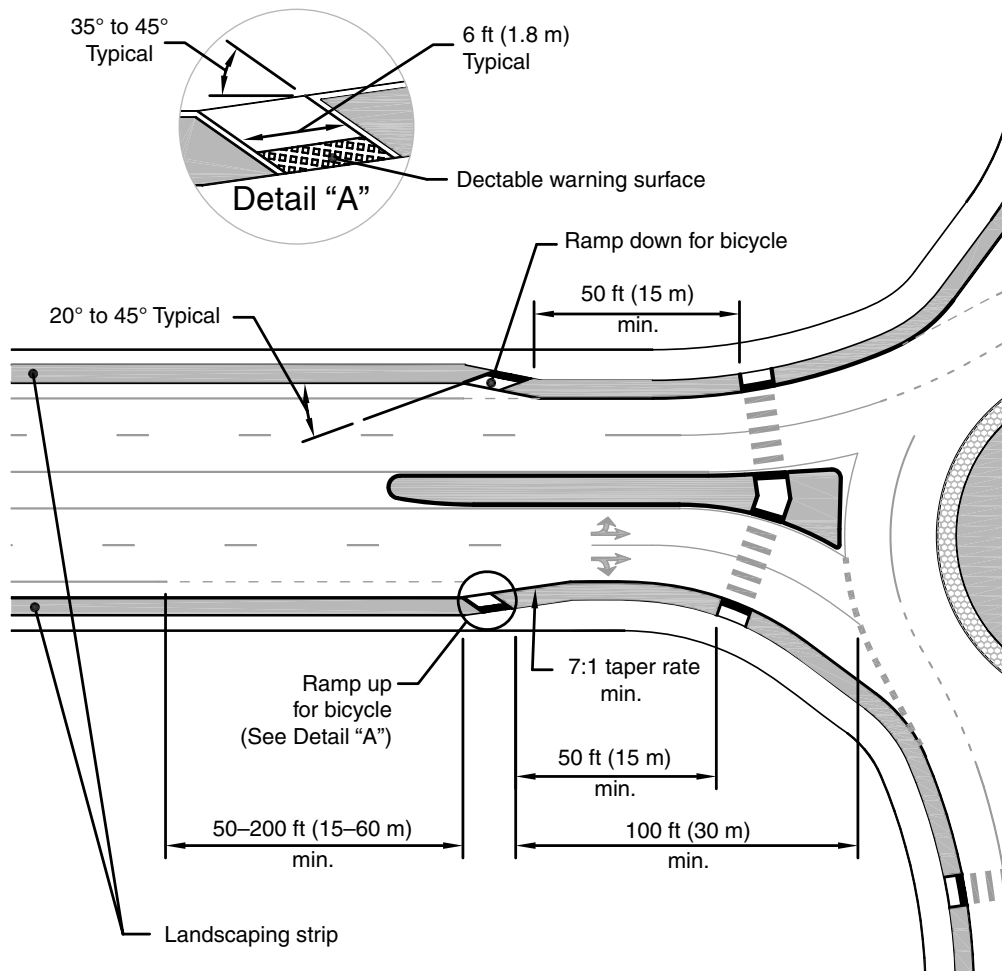

Figure 4-44. Typical Layout of Roundabout with Bike Lanes (4)

Bike lanes should not be located within the circulatory roadway of roundabouts. This design would suggest that bicyclists should ride at the outer edge of the circulatory roadway, which creates turning conflicts at exits and entrances. At roundabout exits, an appropriate taper should begin after the crosswalk, with a dotted line for the bike lane through the taper. The solid bike lane line should resume as soon as the normal bike lane width is available.

Designing for Bicyclists to Traverse Roundabouts on the Sidewalk

Some on-road bicyclists, including children, may not feel comfortable navigating roundabouts on the roadway. Bicycle ramps can be provided to allow access to the sidewalk or a shared use path at the roundabout. Bicycle ramps at roundabouts have the potential to be confused as pedestrian ramps, particularly for pedestrians who have visual impairments. Therefore, bicycle ramps should only be used where the roundabout complexity or design speed may result in less comfort for some bicyclists. As described above, multilane roundabouts are more challenging for bicyclists; therefore bicycle ramps can be useful in these locations. Bicycle ramps may also be appropriate at single-lane roundabouts, if traffic speeds or other conditions (e.g., a right-turn bypass lane) make circulating like other vehicles more challenging for bicyclists. Otherwise, ramps are not normally needed at urban, single-lane roundabouts.

Where bicycle ramps are provided at a roundabout, the publication *Roundabouts: An Informational Guide* (10) anticipates that some bicyclists may choose to leave the roadway and travel as pedestrians to the other side of the roundabout. Consideration may also be given to providing sidewalks with the width recommended for shared use paths (see Section 5.2.1) near roundabouts. In areas with relatively low pedestrian usage and where bicycle usage of the sidewalks is expected to be low, the normal sidewalk width may be sufficient. In some jurisdictions, state or local laws may prohibit bicyclists from riding on sidewalks. In these areas, bicycle ramps would allow less confident bicyclists to walk their bicycles, as a pedestrian, to their desired exit from the roundabout.

The design details of bicycle ramps are critical to their usability, to provide choice to bicyclists, and to reduce the potential for confusion of pedestrians, particularly those who are blind or who have low vision. Bicycle ramps should be placed at the end of the full width bike lane, just before the beginning of the taper for the bike lane. Bicyclists approaching the taper and bike ramp will thus be provided the choice of merging left into the travel lane, or moving to the right onto the sidewalk. Where no bike lane is present on the approach to a roundabout, a bicycle ramp, if used, should be placed at least 50 ft (15 m) prior to the crosswalk at the roundabout. Bicycle ramps should be placed at a 35 to 45 degree angle to the roadway to enable bicyclists to use the ramp even if pulling a trailer, but to discourage them from entering the sidewalk at high speed. Ideally, the sidewalk approaching the roundabout is separated from the roadway with a buffer strip, allowing the ramp to be placed outside of the normal sidewalk area. In this case, the bike ramp can be fairly steep, as it is not intended for pedestrian use (up to 20 percent slope). If placed within the sidewalk area itself, the ramp slope must be built in a manner so that pedestrians are unlikely to trip. A bicycle ramp should not be placed directly in line with the bike lane or otherwise placed in a manner that appears to encourage or require its use.

Since bike ramps can be confusing for pedestrians with visual impairments, detectable warnings should be included on the ramp. Where the ramp is placed in a buffer strip, the detectable warnings should be placed at the top of the ramp, as the ramp itself is part of the vehicular travel facility. If the ramp is in the sidewalk itself, the detectable warning should be placed at the bottom of the ramp. Other aspects of the bike ramp design and placement can help keep pedestrians from misconstruing the bike ramp as a pedestrian crossing location. These aspects include the angle of

the ramp, the possible steeper slope of the ramp, and location of the ramp relatively far from the roundabout and marked crosswalk location.

Bicycle ramps at roundabout exits should be built with similar geometry and placement as the ramps at roundabout entries. Bike ramps should be placed at least 50 ft (15 m) beyond the crosswalk at the roundabout exit.

REFERENCES

1. AASHTO. *A Policy on Geometric Design of Highways and Streets*. American Association of State Highway and Transportation Officials, Washington, DC, 2011.
2. AASHTO. U.S. Bicycle Route System. American Association of State Highway and Transportation Officials. <http://www.transportation.org/Default.aspx?SiteID=68>
3. FHWA. *Manual on Uniform Traffic Control Devices for Streets and Highways*. Federal Highway Administration, U.S. Department of Transportation, Washington, DC, 2009.
4. FHWA. *Technical Summary: Roundabouts*. FHWA-SA-10-006. Federal Highway Administration, U.S. Department of Transportation, Washington, DC, 2010.
5. ITE. *Traffic Calming State of the Practice: An ITE Informational Report*. Institute of Transportation Engineers, Washington, DC, 1999.
6. Iowa Department of Transportation. *Guidelines for the Conversion of Urban Four-Lane Undivided Roadways to Three-Lane Two-Way Left-Turn Lane Facilities*. Center for Transportation Research and Education, Iowa State University, Ames, IA, 2001.
7. Kein, L. L, M. K. Mills, and D.R.P. Gibson. *Traffic Detector Handbook*. Federal Highway Administration, U.S. Department of Transportation, Washington, DC, 2006.
8. Moeur, R. C. and M. N. Bina. *Bicycle–Motor Vehicle Collisions on Controlled Access Highways in Arizona*. s.l. Arizona Department of Transportation, Phoenix, AZ, 2002.
9. Potts, I.B, D. W. Harwood, and K. R. Richard. Relationship of Lane Width to Safety for Urban and Suburban Arterials. In *Transportation Research Record 2023*. Transportation Research Board, National Research Council, Washington, DC, 2007.
10. Rodegerdts, L., et al. *National Cooperative Highway Research Report 672: Roundabouts: An Informational Guide*, Second Edition. Transportation Research Board, Washington, DC, 2010.
11. Torbic, D. J., et al. *National Cooperative Highway Research Report 641: Guidance for the Design and Application of Shoulder and Centerline Rumble Strips*. Transportation Research Board, Washington, DC, 2009.



Design of Shared Use Paths

5.1 INTRODUCTION

Shared use paths are bikeways that are physically separated from motorized vehicular traffic by an open space or barrier and either within the highway right-of-way or within an independent right-of-way. Shared use paths are sometimes referred to as “trails.” However, in many states the term “trail” means an unimproved recreational facility. Care should be taken not to use these terms interchangeably because they have distinctly different design guidelines. Shared use paths should be designed based on the guidance in this guide.

Path users are generally non-motorized and may include but are not limited to:

- Typical upright adult bicyclists
- Recumbent bicyclists
- Bicyclists pulling trailers
- Tandem bicyclists
- Child bicyclists
- Inline skaters
- Roller skaters
- Skateboarders
- Kick scooter users
- Pedestrians (including walkers, runners, people using wheelchairs (both non-motorized and motorized), people with baby strollers, people walking dogs, and others.

Paths are most commonly designed for two-way travel, and the guidance herein assumes a two-way facility is planned unless otherwise stated.

Shared use paths can serve a variety of purposes. They can provide users with a shortcut through a residential neighborhood (e.g., a connection between two cul-de-sac streets) or access to schools. They can provide a commuting route between residential areas and job centers or schools. Located in a park or a greenway, they can provide an enjoyable recreational opportunity. Shared use paths can be located along rivers, ocean fronts, canals, abandoned or active railroad and utility rights-of-way, roadway corridors, limited access freeways, within college campuses, or within parks and open space areas. Shared use paths can also provide bicycle access to areas that are otherwise served only by limited-access highways. Shared use paths that run adjacent to a roadway are called sidepaths. These are discussed further in Section 5.2.2.

Shared use paths should be thought of as a system of off-road transportation routes for bicyclists and other users that extends and complements the roadway network. Shared use paths should not be used to preclude on-road bicycle facilities, but rather to supplement a network of on-road bike lanes, shared roadways, bicycle boulevards, and paved shoulders. Shared use path design is similar to roadway design, but on a smaller scale and with typically lower design speeds.

5.1.1 Accessibility Requirements for Shared Use Paths

Due to the fact that nearly all shared use paths are used by pedestrians, they fall under the accessibility requirements of the Americans with Disabilities Act (ADA). The technical provisions herein either meet or exceed those recommended in current accessibility guidelines. Paths in a public right-of-way that function as sidewalks should be designed in accordance with the proposed *Public Rights-of-Way Accessibility Guidelines (PROWAG) (13)*, or subsequent guidance that may supersede PROWAG in the future. These guidelines also apply to street crossings for all types of shared use paths.

Shared use paths built in independent rights-of-way should meet the draft accessibility guidelines in the *Advance Notice of Proposed Rulemaking (ANPRM) on Accessibility Guideline for Shared Use Paths (12)*, or any subsequent rulemaking that supersedes the ANPRM. The ANPRM separates shared use paths from recreational trails and more closely aligns draft accessibility provisions with those provided for sidewalks and other pedestrian facilities. Refer to the U.S. Access Board website (www.access-board.gov) for up-to-date information regarding the accessibility provisions for shared use paths and other pedestrian facilities covered by the Americans with Disabilities Act and the Architectural Barriers Act.

5.2 ELEMENTS OF DESIGN

Shared use path design criteria are based on the physical and operating characteristics of path users, which are substantially different than motor vehicles. Due to a large percentage of path users being adult bicyclists, they are the primary design user for shared use paths and are the basis for most of the design recommendations in this chapter. This chapter also provides information on critical design issues and values for other potential design users, which should be used in the event that large volumes of these other user types are anticipated.

Some paths are frequently used by children. The operating characteristics of child bicyclists are highly variable, and their specific characteristics have not yet been fully defined through research

studies. However, it is generally assumed that the speed of youth bicyclists is lower than adult bicyclists. Since much of the design criteria in this guide is based on design speed, children will be accommodated to a large extent. When considering criteria unrelated to design speed, engineering judgment should be used when modifying these values for children. Throughout this chapter, several design measures are recommended which are based primarily on pedestrian research. It is presumed that these measures will also benefit bicyclists and other path users, although the research has not been conducted to support this assumption.

5.2.1 Width and Clearance

The usable width and the horizontal clearance for a shared use path are primary design considerations. Figure 5-1 depicts the typical cross section of a shared use path. The appropriate paved width for a shared use path is dependent on the context, volume, and mix of users. The minimum paved width for a two-directional shared use path is 10 ft (3.0 m). Typically, widths range from 10 to 14 ft (3.0 to 4.3 m), with the wider values applicable to areas with high use and/or a wider variety of user groups.

In very rare circumstances, a reduced width of 8 ft (2.4 m) may be used where the following conditions prevail:

- Bicycle traffic is expected to be low, even on peak days or during peak hours.
- Pedestrian use of the facility is not expected to be more than occasional.
- Horizontal and vertical alignments provide frequent, well-designed passing and resting opportunities.
- The path will not be regularly subjected to maintenance vehicle loading conditions that would cause pavement edge damage.

In addition, a path width of 8 ft (2.4 m) may be used for a short distance due to a physical constraint such as an environmental feature, bridge abutment, utility structure, fence, and such. Warning signs that indicate the pathway narrows (W5-4a), per the MUTCD (7) should be considered at these locations.

A wider path is needed to provide an acceptable level of service on pathways that are frequently used by both pedestrians and wheeled users. The *Shared Use Path Level of Service Calculator* is helpful in determining the appropriate width of a pathway given existing or anticipated user volumes and mixes (9). Wider pathways, 11 to 14 ft (3.4 to 4.2 m) are recommended in locations that are anticipated to serve a high percentage of pedestrians (30 percent or more of the total pathway volume) and high user volumes (more than 300 total users in the peak hour). Eleven foot (3.4 m) wide pathways are needed to enable a bicyclist to pass another path user going the same direction, at the same time a path user is approaching from the opposite direction (see Figure 5-2) (8). Wider paths are also advisable in the following situations:

- Where there is significant use by inline skaters, adult tricycles, children, or other users that need more operating width (see Chapter 3);
- Where the path is used by larger maintenance vehicles;

- On steep grades to provide additional passing area; or
- Through curves to provide more operating space.

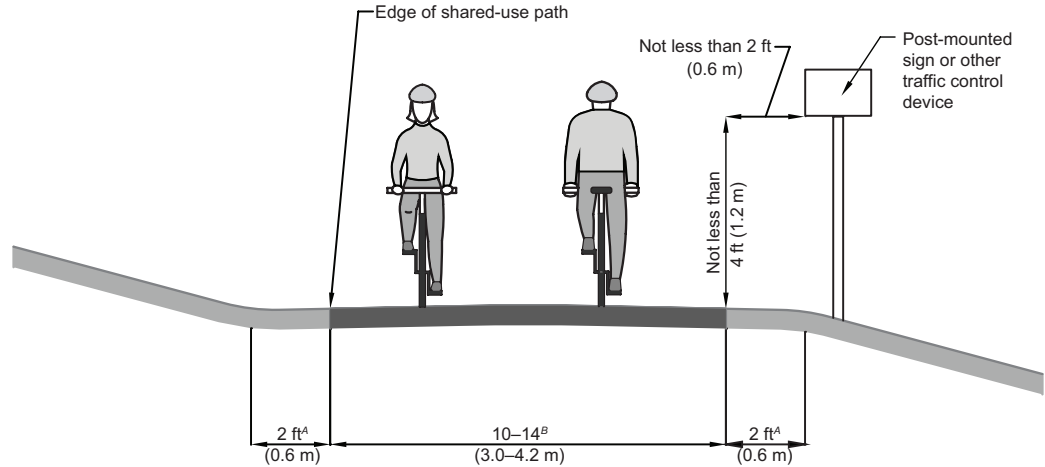

Notes:

^A (1V:6H) Maximum slope (typ.)

^B More if necessary to meet anticipated volumes and mix of users, per the *Shared Use Path Level of Service Calculator* (9)

Figure 5-1. Typical Cross Section of Two-Way, Shared Use Path on Independent Right-of-Way

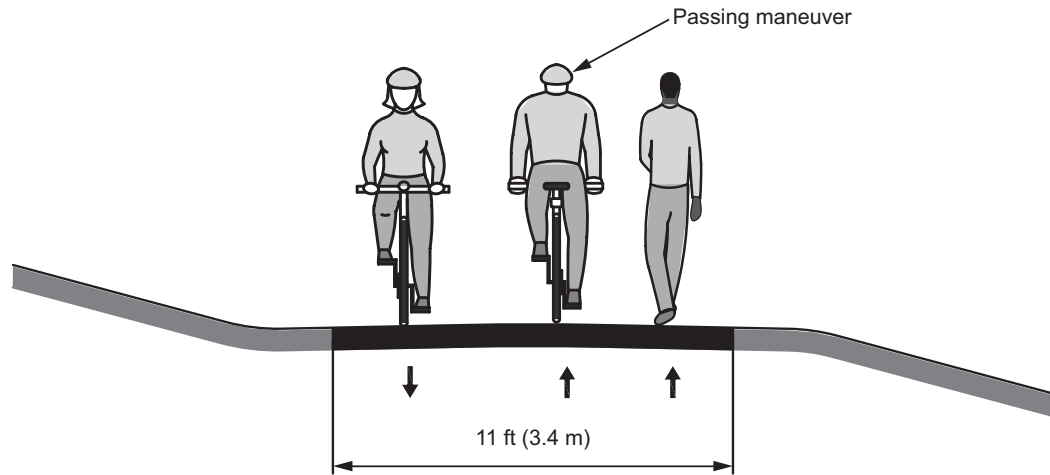

Figure 5-2. Minimum Width Needed to Facilitate Passing on a Shared Use Path

Under most conditions, there is no need to segregate pedestrians and bicyclists on a shared use path, even in areas with high user volumes—they can typically coexist. Path users customarily keep right except to pass. Signs may be used to remind bicyclists to pass on the left and to give an

Chapter 5: Design of Shared Use Paths

audible warning prior to passing other slower users. Part 9 of the MUTCD (7) provides a variety of regulatory signs that can be used for this purpose.

On pathways with heavy peak hour and/or seasonal volumes, or other operational challenges such as sight distance constraints, the use of a centerline stripe on the path can help clarify the direction of travel and organize pathway traffic. A solid yellow centerline stripe may be used to separate two directions of travel where passing is not permitted, and a broken yellow line may be used where passing is permitted. The centerline can either be continuous along the entire length of the path, or may be used only in locations where operational challenges exist. Per the MUTCD, all markings used on bikeways shall be retroreflective.

In areas with extremely heavy pathway volumes, segregation of pedestrians from wheeled users may be appropriate; however, care should be taken that the method of segregation is simple and straightforward. Pedestrians are typically provided with a bi-directional walking lane on one side of the pathway, while bicyclists are provided with directional lanes of travel. This solution should only be used when a minimum path width of 15 ft (4.6 m) is provided, with at least 10 ft (3 m) for two-way wheeled traffic, and at least 5 ft (1.5 m) for pedestrians.

Where this type of segregation is used on a path with a view (e.g., adjacent to a lake or river), the pedestrian lane should be placed on the side of the path with the view. Again, this solution should only be used for pathways with heavy volumes, as pedestrians will often walk in the “bicycle only” portion of a pathway unless it is heavily traveled by bicycles.

Another solution is to provide physically separated pathways for pedestrians and wheeled users. A number of factors should be considered when determining whether to provide separate paths, such as general site conditions (i.e., the width of separation and setting), origins and destinations of different types of path users, and the anticipated level of compliance of users choosing the appropriate path. In some instances, the dual paths may have to come in close proximity or be joined for a distance due to site constraints. As allowed by the MUTCD (7) and described in more detail in Section 5.4.2, mode-specific signs may be used to guide users to their appropriate paths.

Ideally, a graded shoulder area at least 3 to 5 ft (0.9 to 1.5 m) wide with a maximum cross-slope of 1V:6H, which should be recoverable in all weather conditions, should be maintained on each side of the pathway. At a minimum, a 2 ft (0.6 m) graded area with a maximum 1V:6H slope should be provided for clearance from lateral obstructions such as bushes, large rocks, bridge piers, abutments, and poles. The MUTCD requires a minimum 2 ft (0.6 m) clearance to post-mounted signs or other traffic control devices (7). Where “smooth” features such as bicycle railings or fences are introduced with appropriate flaring end treatments (as described below), a lesser clearance (not less than 1 ft [0.3 m]) is acceptable. If adequate clearance cannot be provided between the path and lateral obstructions, then warning signs, object markers, or enhanced conspicuity and reflectorization of the obstruction should be used.

Where a path is adjacent to parallel bodies of water or downward slopes of 1V:3H or steeper, a wider separation should be considered. A 5 ft (1.5 m) separation from the edge of the path pavement to the top of the slope is desirable. Depending on the height of the embankment and condition at the bottom, a physical barrier, such as dense shrubbery, railing, or fencing may be needed. This is an area where engineering judgment should be applied, as the risk for a bicyclist who runs off the path should be compared to the risk posed by the rail. Where a recovery area

(i.e., distance between the edge of the path pavement and the top of the slope) is less than 5 ft (1.5 m), physical barriers or rails are recommended in the following situations (see Figure 5-3):

- Slopes 1V:3H or steeper, with a drop of 6 ft (1.8 m) or greater;
- Slopes 1V:3H or steeper, adjacent to a parallel body of water or other substantial obstacle;
- Slopes 1V:2H or steeper, with a drop of 4 ft (1.2 m) or greater; and
- Slopes 1V:1H or steeper, with a drop of 1 ft (0.3 m) or greater.

The barrier or rail should begin prior to, and extend beyond the area of need. The lateral offset of the barrier should be at least 1 ft (0.3 m) from the edge of the path. The ends of the barrier should be flared away from the path edge. Barrier or rail ends that remain within the 2 ft (0.6 m) clear area should be marked with object markers.

Railings that are used to protect users from slopes or to discourage path users from venturing onto a roadway or neighboring property can typically have relatively large openings. A typical design includes two to four horizontal elements with vertical elements spaced fairly widely, but frequently enough to provide the needed structural support and in accordance with applicable building codes. Where there is a high vertical drop or a body of water adjacent to the path where a railing is provided, engineering judgment should be used to determine whether a railing suitable for bridges (as described in Section 5.2.10) should be provided.

Other materials in addition to railings can be used to separate paths from adjacent areas, either due to substantial obstacles or to discourage pathway users from venturing onto adjacent properties. Berms and/or vegetation can serve this function.

It is not desirable to place the pathway in a narrow corridor between two fences for long distances, as this creates personal security issues, prevents users who need help from being seen, prevents path users from leaving the path in an emergency, and impedes emergency response.

The desirable vertical clearance to obstructions is 10 ft (3.0 m). Fixed objects should not be permitted to protrude within the vertical or horizontal clearance of a shared use path. The recommended minimum vertical clearance that can be used in constrained areas is 8 ft (2.4 m). In some situations, vertical clearance greater than 10 ft (3.0 m) may be needed to permit passage of maintenance and emergency vehicles.

Chapter 5: Design of Shared Use Paths

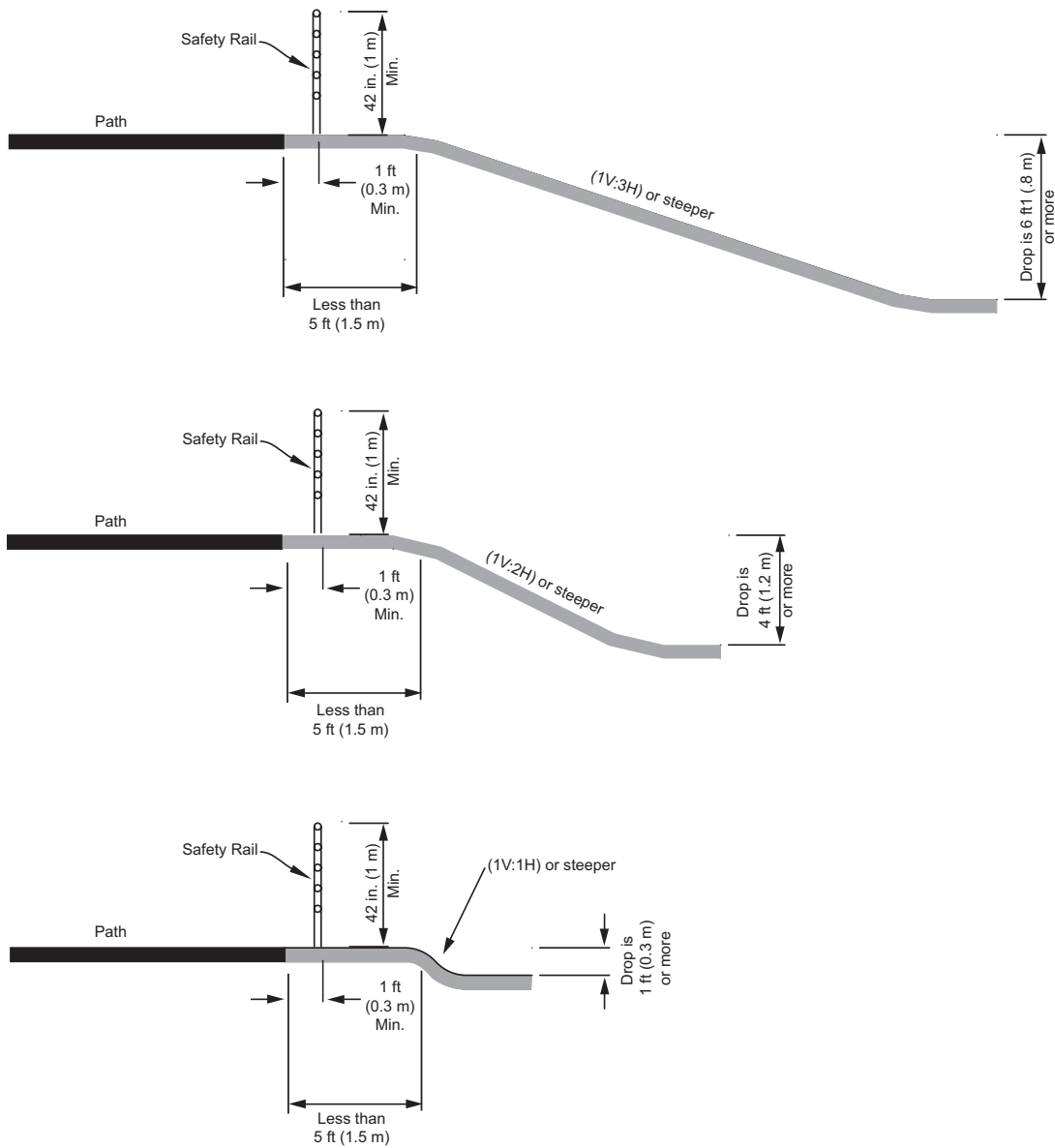

Figure 5-3. Safety Rail Between Path and Adjacent Slope

5.2.2 Shared Use Paths Adjacent to Roadways (Sidepaths)

While it is generally preferable to select path alignments in independent rights-of-way, there are situations where existing roads provide the only corridors available. Sidepaths are a specific type of shared use path that run adjacent to the roadway, where right-of-way and other physical constraints dictate. Children often prefer and/or are encouraged to ride on sidepaths because they provide an element of separation from motor vehicles. As stated in Chapter 2, provision of a pathway adjacent to the road is not a substitute for the provision of on-road accommodation such as paved shoulders or bike lanes, but may be considered in some locations in addition to on-road bicycle facilities. A sidepath should satisfy the same design criteria as shared use paths in independent rights-of-way.

The discussion in this section refers to two-way sidepaths. Additional design considerations for sidepaths are provided in Section 5.3.4. Utilizing or providing a sidewalk as a shared use path is undesirable. Section 3.4.2 highlights the reasons sidewalks generally are not acceptable for bicycling. It is especially inappropriate to sign a sidewalk as a shared use path if doing so would prohibit bicyclists from using an alternate facility that might better serve their needs. In general, the guiding principle for designing sidewalks should be that sidewalks intended for use by bicyclists should be designed as sidepaths, and sidewalks not intended for use by bicyclists should be designed according to the AASHTO *Guide for the Planning, Design, and Operation of Pedestrian Facilities* (2).

Paths can function along highways for short sections, or for longer sections where there are few street and/or driveway crossings, given appropriate separation between facilities and attention to reducing crashes at junctions. However before committing to this option for longer distances on urban and suburban streets with many driveways and street crossings, practitioners should be aware that two-way sidepaths can create operational concerns. See Figure 5-4 for examples of potential conflicts associated with sidepaths. These conflicts include:

1. At intersections and driveways, motorists entering or crossing the roadway often will not notice bicyclists approaching from their right, as they do not expect wheeled traffic from this direction. Motorists turning from the roadway onto the cross street may likewise fail to notice bicyclists traveling the opposite direction from the norm.
2. Bicyclists traveling on sidepaths are apt to cross intersections and driveways at unexpected speeds (i.e., speeds that are significantly faster than pedestrian speeds). This may increase the likelihood of crashes, especially where sight distance is limited.
3. Motorists waiting to enter the roadway from a driveway or side street may block the sidepath crossing, as drivers pull forward to get an unobstructed view of traffic (this is the case at many sidewalk crossings, as well).
4. Attempts to require bicyclists to yield or stop at each cross-street or driveway are inappropriate and are typically not effective.
5. Where the sidepath ends, bicyclists traveling in the direction opposed to roadway traffic may continue on the wrong side of the roadway. Similarly, bicyclists approaching a path may travel on the wrong side of the roadway to access the path. Wrong-way travel by bicyclists is a common factor in bicycle-automobile crashes.

6. Depending upon the bicyclist's specific origin and destination, a two-way sidepath on one side of the road may need additional road crossings (and therefore increase exposure); however, the sidepath may also reduce the number of road crossings for some bicyclists.
7. Signs posted for roadway users are backwards for contra-flow riders, who cannot see the sign information. The same applies to traffic signal faces that are not oriented to contra-flow riders.
8. Because of proximity of roadway traffic to opposing path traffic, barriers or railings are sometimes needed to keep traffic on the roadway or path from inappropriately encountering the other. These barriers can represent an obstruction to bicyclists and motorists, impair visibility between road and path users, and can complicate path maintenance.
9. Sidepath width is sometimes constrained by fixed objects (such as utility poles, trash cans, mailboxes, and etc.).
10. Some bicyclists will use the roadway instead of the sidepath because of the operational issues described above. Bicyclists using the roadway may be harassed by motorists who believe bicyclists should use the sidepath. In addition, there are some states that prohibit bicyclists from using the adjacent roadway when a sidepath is present.
11. Bicyclists using a sidepath can only make a pedestrian-style left turn, which generally involves yielding to cross traffic twice instead of only once, and thus induces unnecessary delay.
12. Bicyclists on the sidepath, even those going in the same direction, are not within the normal scanning area of drivers turning right or left from the adjacent roadway into a side road or driveway.
13. Even if the number of intersection and driveway crossings is reduced, bicycle–motor vehicle crashes may still occur at the remaining crossings located along the sidepath.
14. Traffic control devices such as signs and markings have not been shown effective at changing road or path user behavior at sidepath intersections or in reducing crashes and conflicts.

For these reasons, other types of bikeways may be better suited to accommodate bicycle traffic along some roadways.

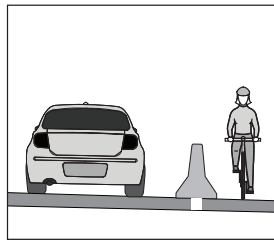

Barriers, while needed in tight spaces, can narrow both roadway and path, and create hazards.

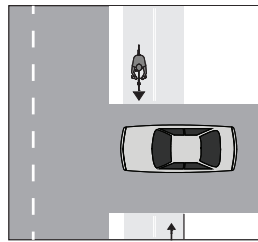

Stopped motor vehicles on side streets or driveways may block the path.

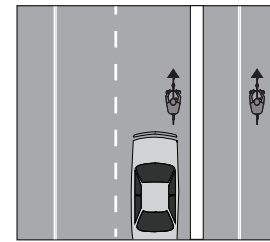

Some bicyclists may find the road cleaner, safer, and more convenient. Motorists may believe bicyclists should use a sidepath.

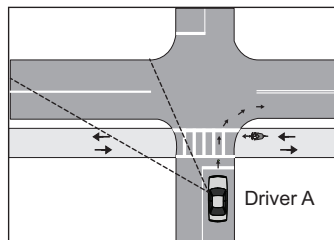

Right turning Driver A is looking for traffic on the left. A contraflow bicyclist is not in the driver's main field of vision.

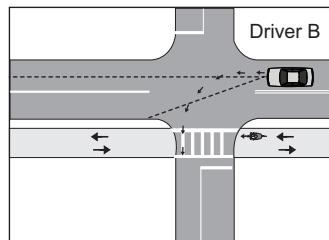

Left turning Driver B is looking for traffic ahead. A contraflow bicyclist is not in the driver's main field of vision.

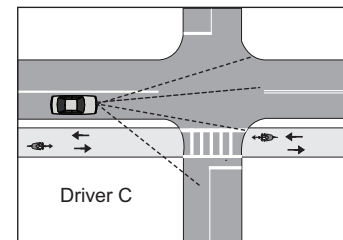

Right turning Driver C is looking for left turning traffic on the main road and traffic on the minor road. A bicyclist riding with traffic is not in the driver's main field of vision.

Figure 5-4. Sidepath Conflicts

Shared use paths in road medians are generally not recommended. These facilities result in multiple conflicting turning movements by motorists and bicyclists at intersections. Therefore, shared use paths in medians should be considered only where these turning conflicts can be avoided or mitigated through signalization or other techniques.

Guidelines for Sidepaths

Although paths in independent rights-of-way are preferred, sidepaths may be considered where one or more of the following conditions exist:

- The adjacent roadway has relatively high-volume and high-speed motor vehicle traffic that might discourage many bicyclists from riding on the roadway, potentially increasing sidewalk riding, and there are no practical alternatives for either improving the roadway or accommodating bicyclists on nearby parallel streets.
- The sidepath is used for a short distance to provide continuity between sections of path in independent rights-of-way, or to connect local streets that are used as bicycle routes.
- The sidepath can be built with few roadway and driveway crossings.
- The sidepath can be terminated at each end onto streets that accommodate bicyclists, onto another path, or in a location that is otherwise bicycle compatible.

In some situations, it may be better to place one-way sidepaths on both sides of the street or highway, directing wheeled users to travel in the same direction as adjacent motor vehicle traffic. Clear directional information is needed if this type of design is used, as well as appropriate intersection design to enable bicyclists to cross to the other side of the roadway. This can reduce some of the concerns associated with two-way sidepaths at driveways and intersections; however, it should be done with the understanding that many bicyclists will ignore the directional indications if they involve additional crossings or otherwise inconvenient travel patterns.

A wide separation should be provided between a two-way sidepath and the adjacent roadway to demonstrate to both the bicyclist and the motorist that the path functions as an independent facility for bicyclists and other users. The minimum recommended distance between a path and the roadway curb (i.e., face of curb) or edge of traveled way (where there is no curb) is 5 ft (1.5 m). Where a paved shoulder is present, the separation distance begins at the outside edge of the shoulder. Thus, a paved shoulder is not included as part of the separation distance. Similarly, a bike lane is not considered part of the separation; however, an unpaved shoulder (e.g., a gravel shoulder) can be considered part of the separation. Where the separation is less than 5 ft (1.5 m), a physical barrier or railing should be provided between the path and the roadway. Such barriers or railings serve both to prevent path users from making undesirable or unintended movements from the path to the roadway and to reinforce the concept that the path is an independent facility. A barrier or railing between a shared use path and adjacent highway should not impair sight distance at intersections, and should be designed to limit the potential for injury to errant motorists and bicyclists. The barrier or railing need not be of size and strength to redirect errant motorists toward the roadway, unless other conditions indicate the need for a crashworthy barrier. Barriers or railings at the outside of a structure or a steep fill embankment that not only define the edge of a sidepath but also prevent bicyclists from falling over the rail to a substantially lower elevation should be a minimum of 42 in. (1.05 m) high. Barriers at other locations that serve only to separate the area for motor vehicles from the sidepath should generally have a minimum height equivalent to the height of a standard guardrail.

When a sidepath is placed along a high-speed highway, a separation greater than 5 ft (1.5 m) is desirable for path user comfort. If greater separation cannot be provided, use of a crashworthy barrier should be considered. Other treatments such as rumble strips can be considered as alternatives to physical barriers or railings, where the separation is less than 5 ft (1.5 m). However, as in the case of rumble strips, an alternative treatment should not negatively impact bicyclists who choose to ride on the roadway rather than the sidepath. Providing separation between a sidepath and the adjacent roadway does not necessarily resolve the operational concerns for sidepaths at intersections and driveways. See Section 5.3.4 for guidance on the design of sidepath intersections.

5.2.3 Shared Use with Mopeds, Motorcycles, Snowmobiles, and Horses

Although in some jurisdictions it may be permitted, it is undesirable to mix mopeds, motorcycles, or all-terrain vehicles with bicyclists and pedestrians on shared use paths. In general, these types of motorized vehicles should not be allowed on shared use paths because of conflicts with slower moving bicyclists and pedestrians. Motorized vehicles also diminish the quiet, relaxing experience most users seek on paths. Motorized wheelchairs are an exception to this rule, and should be permitted to access shared use paths. In cases where mopeds or other similar motorized users are permitted and are expected to use the pathway, providing additional width and improved sight lines may reduce conflicts. Signs that emphasize appropriate user etiquette may also be useful.

Bicycling and equestrian use have successfully been integrated on many pathways in the United States. However, care should be taken in designing these facilities to reduce potential conflicts between users. Bicyclists are often unaware of the need for slower speeds and additional clearance around horses. Horses can be startled easily and may act unpredictably if they perceive approaching bicyclists as a danger. Measures to mitigate bicyclist–equestrian conflicts include provision of separate bridle paths, maintenance of adequate sight lines so that bicyclists and equestrians are able to see each other well in advance, and signing that clarifies appropriate passing techniques and yielding responsibilities. Along paths with high- to moderate-use, the separate paved and unpaved treads should be divided by at least a 6-ft (1.8-m) wide vegetation buffer or barrier. Consideration can also be given to providing an elevation change between the treads (15). Where used, a separate, unpaved bridle path can often serve a dual purpose, as many joggers also prefer unpaved surfaces (see Figure 5-5).

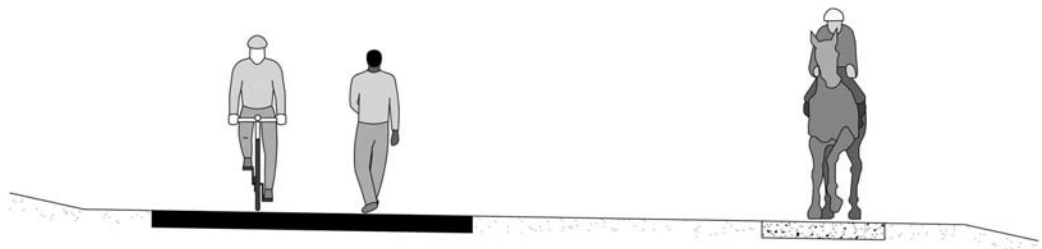

Figure 5-5. Shared Use Path with Separate Unpaved Equestrian/Jogger Path

5.2.4 Design Speed

Design speed is a selected speed used to determine various geometric features of the shared use path. Once the design speed is selected, all pertinent path features should be related to it to obtain a balanced design. In most situations, shared use paths should be designed for a speed that is at least as high as the preferred speed of the fastest common user. The speed a path user travels is dependent on several factors, including the physical condition of the user; the type and condition of the user's equipment; the purpose and length of the trip; the condition, location, and grade of the path; the prevailing wind speed and direction; and the number and types of other users on the path.

There is no single design speed that is recommended for all paths. When selecting an appropriate design speed for a specific path, planners and designers should consider several factors including the context of the path, the types of users expected, the terrain the path runs through, prevailing winds, the path surface, and other path characteristics. The following examples help to illustrate these factors:

- **Types of Users and Context.** An urban path with a variety of users and frequent conflicts and constraints may be designed for lower speeds than a rural path with few conflicts that is primarily used by recreational bicyclists (potentially including recumbent bicyclists, whose 85th percentile speed is 18 mph [29 km/h]).
- **Terrain.** A path in fairly hilly terrain should be designed for a higher speed.
- **Path Surface.** Bicyclists tend to ride slower on unpaved paths, so a lower design speed may be used.

In street and highway design, design speeds are generally selected in 5 mph or 10 km/h increments; which are based on the approximate 85th percentile speed range on various types of roadways of 20 mph (30 km/h) to 75 mph (120 km/h) or higher. On paths, the range of speeds is much smaller, ranging as low as 12 mph (19 km/h) to 30 mph (50 km/h). Therefore, design speeds for paths can be selected in 2 mph (3 km/h) increments. Design criteria for geometric features in this document are provided in 2 mph (3 km/h) increments for the slower end of the scale (design speeds between 12 mph [19 km/h] and 20 mph [32 km/h]). For design speeds above 20 mph (32 km/h), 5 mph (8 km/h) increments are used.

The following guidance and the aforementioned consideration of various factors should guide the selection of an appropriate design speed:

- For most paths in relatively flat areas (grades less than 2 percent), a design speed of 18 mph (30 km/h) is generally sufficient, except on inclines where higher speeds can occur. The design speed should not be lower, except in rare circumstances where the context and user types support a lower speed.
- In areas with hilly terrain and sustained steeper grades (6 percent or greater), the appropriate design speed should be selected based on the anticipated travel speeds of bicyclists going downhill. In all but the most extreme cases, 30 mph (48 km/h) is the maximum design speed that should be used.

Lower speeds can reduce the likelihood for crashes at approaches to crossings or conflict points by allowing the path user to better perceive the crossing situation or potential conflict. It is important to give the bicyclist adequate warning (either through signs or by maintaining adequate sight lines) prior to areas of the pathway where lower design speeds are employed. See Section 5.4.2 for guidance on warning signs.

Geometric design and traffic control devices can be used to reduce path users' speed. Speeds can be reduced by geometric features such as horizontal curvature. Effectiveness of speed control through design is limited if bicyclists can veer off a path to "straighten out" curves, and speed limit signs on paths may not be effective, as most bicyclists do not use speedometers.

5.2.5 Horizontal Alignment

The typical adult bicyclist is the design user for horizontal alignment. The minimum radius of horizontal curvature for bicyclists can be calculated using two different methods. One method uses "lean angle," and the other method uses superelevation and coefficient of friction. As detailed below, in general, the lean angle method should be used in design, although there are situations where the superelevation method is helpful.

Calculating Minimum Radius Using Lean Angle

Unlike an automobile, a bicyclist must lean while cornering to prevent falling outward due to forces associated with turning movements. Most bicyclists usually do not lean drastically; 20 degrees is considered the typical maximum lean angle for most users (*I0*). Assuming an operator who sits straight in the seat, Table 5-1 shows an equation that can determine the minimum radius of curvature for any given lean angle and design speed.

Table 5-1. Minimum Radius of Curvature Based on Lean Angle

U.S. Customary			Metric		
$R = \frac{0.067V^2}{\tan \theta}$			$R = \frac{0.0079V^2}{\tan \theta}$		
where:			where:		
R	=	minimum radius of curvature (ft)	R	=	minimum radius of curvature (m)
V	=	design speed (mph)	V	=	design speed (km/h)
θ	=	lean angle from the vertical (degrees)	θ	=	lean angle from the vertical (degrees)

As described in Section 5.1.1, shared use paths should meet accessibility guidelines, which restrict the steepness of cross slopes. One percent slopes are recommended on shared use paths where practical, because they are easier to navigate for people using wheelchairs. In most cases the lean angle formula should be used when determining the minimum radius of a horizontal curve, due to the need for relatively flat cross slopes and the fact that bicyclists lean when turning (regardless of their speed or the radius of their turn). The curve radius should be based upon various design speeds of 18 to 30 mph (29 to 48 km/h) and a desirable maximum lean angle of 20 degrees. Lower design speeds of 12 to 16 mph (19 to 26 km/h) may be appropriate under some circumstances (e.g., where environmental or physical constraints limit the geometrics). Minimum radii of curvature for a paved path can be selected from Table 5-2.

Table 5-2. Minimum Radii for Horizontal Curves on Paved, Shared Use Paths at 20-Degree Lean Angle

U.S. Customary		Metric	
Design Speed (mph)	Minimum Radius (ft)	Design Speed (km/h)	Minimum Radius (m)
12	27	19	8
14	36	23	11
16	47	26	15
18	60	29	18
20	74	32	22
25	115	40	35
30	166	48	50

Calculating Minimum Radius Using Superelevation

The second method of calculating minimum radius of curvature negotiable by a bicycle uses the design speed, the superelevation rate of the pathway surface, and the coefficient of friction between the bicycle tires and the surface, as shown in Table 5-3:

Table 5-3. Minimum Radius of Curvature Based on Superelevation

U.S. Customary			Metric		
$R = \frac{V^2}{15 \left(\frac{e}{100} + f \right)}$			$R = \frac{V^2}{127 \left(\frac{e}{100} + f \right)}$		
where:			where:		
R	=	minimum radius of curvature (ft)	R	=	minimum radius of curvature (m)
V	=	design speed (mph)	V	=	design speed (km/h)
e	=	rate of bikeway superelevation (percent)	e	=	rate of bikeway superelevation (percent)
f	=	coefficient of friction	f	=	coefficient of friction

The coefficient of friction depends upon speed, surface type and condition, tire type and condition, and whether the surface is wet or dry. Friction factors used for design should be selected based upon the point at which turning forces or perceived lack of surface traction causes the bicyclist to recognize a feeling of discomfort and instinctively act to avoid higher speed. Extrapolating from values used in highway design, design friction factors for paved shared use paths can be assumed to vary from 0.34 at 6 mph (10 km/h) to 0.21 at 30 mph (48 km/h). On unpaved surfaces, friction factors should be reduced by 50 percent to reduce the likelihood of crashes.

Calculating minimum radius based on superelevation may be useful on unpaved paths, where bicyclists may be hesitant to lean as much while cornering due to the perceived lack of traction. In these situations, the superelevation formula should be used with appropriate friction factors for unpaved surfaces. Calculating minimum radius based on superelevation may also be useful on paved paths intended for bicycle use only, allowing higher design speeds to be accommodated on relatively sharp curves with cross slopes (superelevation) up to 8 percent.

When a radius is smaller than that needed for an 18 mph (29 km/h) design speed, standard turn or curve warning signs (W1 series) should be installed in accordance with the MUTCD (7). Smaller radius curves are typically used when there are constrained site conditions, topographic challenges, or a desire to reduce path user speeds. The negative effects of sharper curves can also be partially offset by widening the pavement through the curves.

5.2.6 Cross Slope

As previously described, shared use paths must be accessible to people with disabilities. Shared use paths located adjacent to roadways essentially function as sidewalks, and therefore should follow PROWAG (13), which requires that cross slopes not exceed 2 percent. Until the specific regulations concerning shared use paths are completed (14), paths in independent rights-of-way should be designed according to ANPRM on Shared Use Paths (12), which also requires that cross slopes not exceed 2 percent. As described in the previous section, 1 percent cross slopes are recommended on shared use paths, to better accommodate people with disabilities and to provide enough slope to convey surface drainage in most situations. A cross-section that provides a center crown with no more than 1 percent in each direction may also be used.

Because this guide recommends a relatively flat cross slope of 1 percent, and because horizontal curvature can be based on a 20-degree lean angle, superelevation for horizontal curvature is not needed. Since superelevation is not needed for horizontal curvature, cross slopes can follow the direction of the existing terrain. This practice enables the designer to better accommodate surface drainage and lessen construction impacts.

If cross slopes steeper than 2 percent are needed, they should be sloped to the inside of horizontal curves regardless of drainage conditions. Steeper cross slopes (up to 5 percent) may occasionally be desirable on unpaved shared use paths to reduce the likelihood of puddles caused by surface irregularities and to allow increased superelevation to achieve smaller radii of curvature, as previously described in the subsection on horizontal alignment. In rare situations where a path is intended for bicycle use only (e.g., pedestrians are accommodated on a separate pathway) and does not need to meet accessibility guidelines, cross slopes between 5 and 8 percent can be used to allow for smaller minimum horizontal curve radii, as discussed above.

Cross slopes should be transitioned to connect to existing slopes, or to adjust to a reversal of predominant terrain slope or drainage, or to a horizontal curve in some situations. Cross slope transitions should be comfortable for the path user. A minimum transition length of 5 ft (1.5 m) for each 1 percent change in cross slope should be used.

5.2.7 Grade

The maximum grade of a shared use path adjacent to a roadway should be 5 percent, but the grade should generally match the grade of the adjacent roadway. Where a shared use path runs along a roadway with a grade that exceeds 5 percent, the sidepath grade may exceed 5 percent but must be less than or equal to the roadway grade. Grades on shared use paths in independent rights-of-way should be kept to a minimum, especially on long inclines. Grades steeper than 5 percent are undesirable because the ascents are difficult for many path users, and the descents cause some users to exceed the speeds at which they are competent or comfortable. In addition, because shared use paths are generally open to pedestrians, the allowable grades on paths are subject to the accessibility guidelines described in the *ANPRM on Shared Use Paths* (12). Grades on paths in independent rights-of-way should also be limited to 5 percent maximum. The ANPRM suggests that certain conditions such as physical constraints (existing terrain or infrastructure, notable natural features, etc.) or regulatory constraints (endangered species, the environment, etc.) may prevent full compliance with the 5 percent maximum grade. Refer to the U.S. Access Board website (www.access-board.gov) for up-to-date information regarding the accessibility provisions for shared-use paths covered by the Americans with Disabilities Act and the Architectural Barriers Act.

Options to mitigate excessive grades on shared use pathways include the following:

- Use higher design speeds for horizontal and vertical curvature, stopping sight distance, and other geometric features.
- When using a longer grade, consider an additional 4 to 6 ft (1.2 to 1.8 m) of width to permit slower bicyclists to dismount and walk uphill, and to provide more maneuvering space for fast downhill bicyclists.
- Install the hill warning sign for bicyclists (W7-5) and advisory speed plaque, if appropriate, per the MUTCD (7).

- Provide signing that alerts path users to the maximum percent of grade as shown in the MUTCD (7).
- Exceed minimum horizontal clearances, recovery area, and/or protective railings.
- If other designs are not practicable, use a series of short switchbacks to traverse the grade. If this is done, an extra 4 to 6 ft (1.2 to 1.8 m) of path width is recommended to provide maneuvering space.
- Provide resting intervals with flatter grades, to permit users to stop periodically and rest.

Grades steeper than 3 percent may not be practical for shared use paths with crushed stone or other unpaved surfaces for both bicycle handling and drainage erosion reasons. Typically, grades less than 0.5 percent should be avoided, because they are not efficient in conveying surface drainage. Where paths are built in very flat terrain, proposed path grades can be increased to provide a gradually rolling vertical profile that helps convey surface drainage to outlet locations.

5.2.8 Stopping Sight Distance

To provide path users with opportunities to see and react to unexpected conditions, shared use paths should be designed with adequate stopping sight distances. The distance needed to bring a path user to a fully controlled stop is a function of the user’s perception and braking reaction times, the initial speed, the coefficient of friction between the wheels and the pavement, the braking ability of the user’s equipment, and the grade. The coefficient of friction for the typical bicyclist is 0.32 for dry conditions. Figures 5-6 and 5-7 indicates the minimum stopping sight distance for various design speeds and grades based on a total perception and brake reaction time of 2.5 seconds and a coefficient of friction of 0.16 (Table 5-4), appropriate for wet conditions. Minimum stopping sight distance can also be calculated using the equation shown in Table 5-4.

Table 5-4. Minimum Stopping Sight Distance

U.S. Customary			Metric		
$S = \frac{V^2}{30(f \pm G)} + 3.67V$			$S = \frac{V^2}{254(f \pm G)} + \frac{V}{1.4}$		
where:			where:		
S	=	stopping sight distance (ft)	S	=	stopping sight distance (m)
V	=	velocity (mph)	V	=	velocity (km/h)
f	=	coefficient of friction (use 0.16 for a typical bike)	f	=	coefficient of friction (use 0.16 for a typical bike)
G	=	grade (ft/ft) (rise/run)	G	=	grade (m/m) (rise/run)

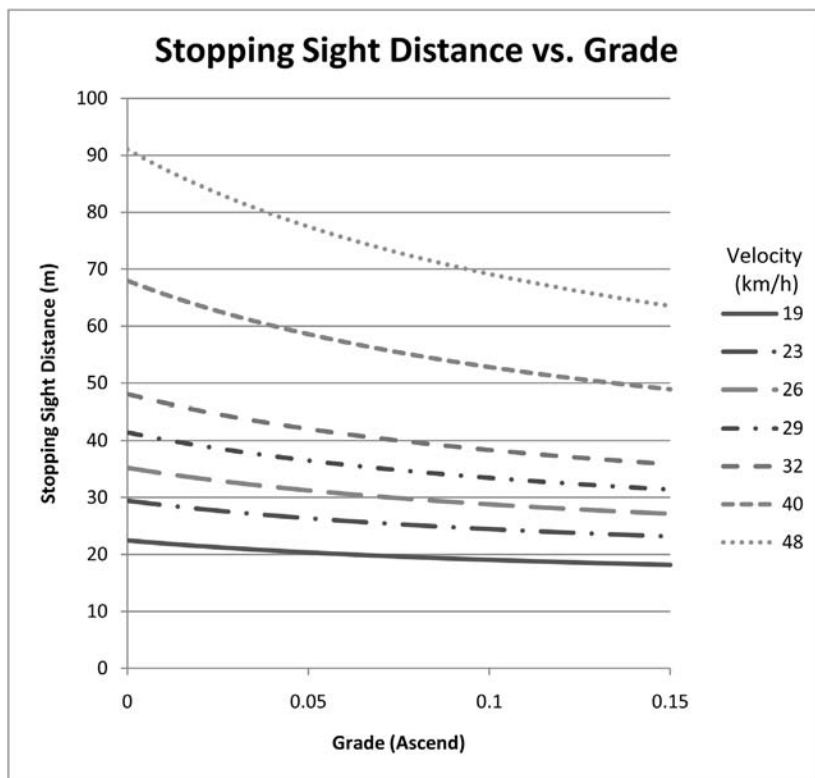
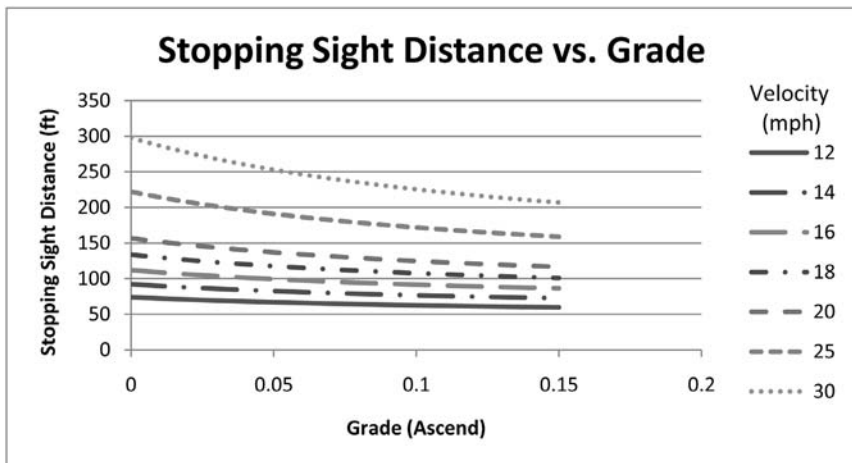

Figure 5-6. Minimum Stopping Sight Distance vs. Grades for Various Design Speeds—Ascending Climbing Grade

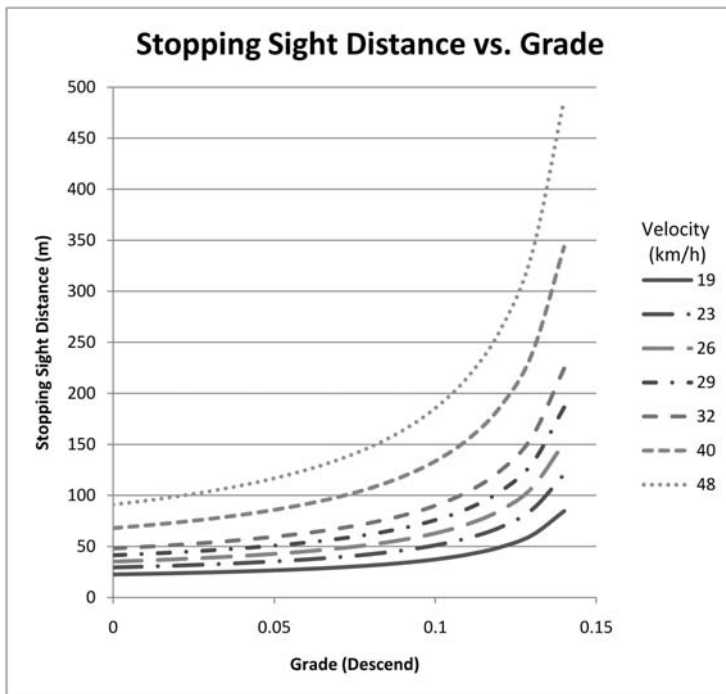
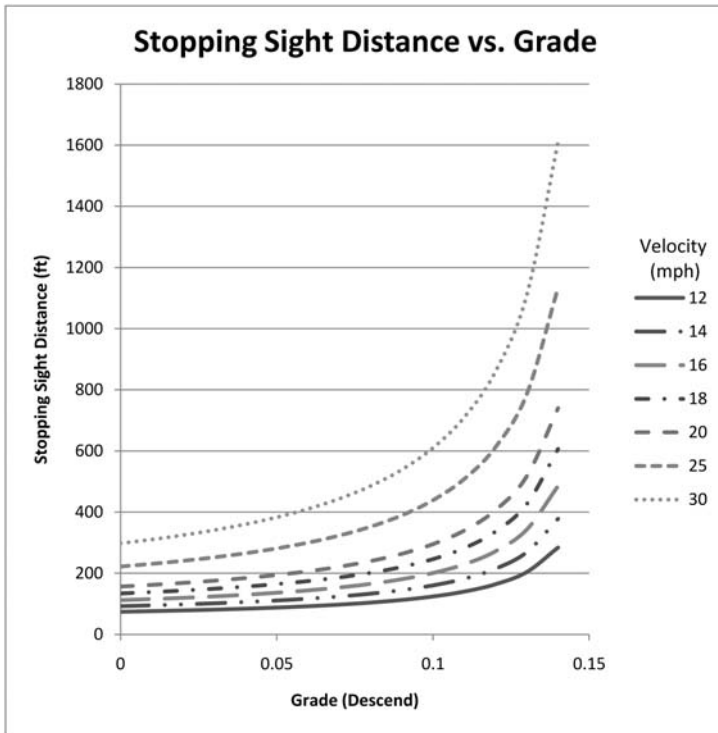

Figure 5-7. Minimum Stopping Sight Distance vs. Grades for Various Design Speeds—Descending Climbing Grade

Research indicates that, under dry conditions, the coefficient of friction of various other path users range from 0.20 for inline skaters to 0.30 for recumbent bicyclists. If users with lower coefficients of friction such as inline skaters or recumbent bicyclists are expected to make up a relatively large percentage of path users, stopping sight distances should be increased. For two-way shared use paths, the sight distance in the descending direction, that is, where “G” is defined as negative, will control the design.

Figure 5-8 is used to select the minimum length of vertical curve needed to provide minimum stopping sight distance at various speeds on crest vertical curves. The eye height of the typical adult bicyclist is assumed to be 4.5 ft (1.4 m), and the object height is assumed to be 0 in. (0 mm) to recognize that impediments to bicycle travel exist at pavement level. The minimum length of vertical curve can also be calculated using the following equation as shown in Table 5-5.

Table 5-5. Length of Crest Vertical Curve to Provide Sight Distance

U.S. Customary			Metric		
$S < L \quad L = 2S - \frac{200(\sqrt{h_1} + \sqrt{h_2})^2}{A}$			$S < L \quad L = 2S - \frac{200(\sqrt{h_1} + \sqrt{h_2})^2}{A}$		
$S < L \quad L = 2S - \frac{AS^2}{100(\sqrt{2h_1} + \sqrt{2h_2})^2}$			$S < L \quad L = 2S - \frac{AS^2}{100(\sqrt{2h_1} + \sqrt{2h_2})^2}$		
where:			where:		
L	=	minimum length of vertical curve (ft)	L	=	minimum length of vertical curve (m)
A	=	algebraic grade difference (percent)	A	=	algebraic grade difference (percent)
S	=	stopping sight distance (ft)	S	=	stopping sight distance (m)
h_1	=	eye height (4.5 ft for a typical bicyclist)	h_1	=	eye height (1.4 m for a typical bicyclist)
h_2	=	object height (0 ft)	h_2	=	object height (0 m)

Chapter 5: Design of Shared Use Paths

U.S. Customary

A	S = Stopping Sight Distance (ft)															
	(%)	20	40	60	80	100	120	140	160	180	200	220	240	260	280	300
2													30	70	110	150
3								20	60	100	140	180	220	260	300	
4						15	55	95	135	175	215	256	300	348	400	
5					20	60	100	140	180	222	269	320	376	436	500	
6				10	50	90	130	170	210	267	323	384	451	523	600	
7				31	71	111	151	191	231	311	376	448	526	610	700	
8			8	48	88	128	168	208	248	356	430	512	601	697	800	
9			20	60	100	140	180	220	260	400	484	576	676	784	900	
10			30	70	110	150	190	230	270	444	538	640	751	871	1000	
11			38	78	118	158	198	238	278	489	592	704	826	958	1100	
12		5	45	85	125	165	205	245	285	533	645	768	901	1045	1200	
13		11	51	91	131	171	211	251	291	578	699	832	976	1132	1300	
14		16	56	96	136	176	216	256	296	622	753	896	1052	1220	1400	
15		20	60	100	140	180	220	260	300	667	807	960	1127	1307	1500	
16		24	64	104	144	184	224	264	304	711	860	1024	1202	1394	1600	
17		27	67	107	147	187	227	267	307	756	914	1088	1277	1481	1700	
18		30	70	110	150	190	230	270	310	800	968	1152	1352	1568	1800	
19		33	73	113	153	193	233	273	313	844	1022	1216	1427	1655	1900	
20		35	75	115	155	195	235	275	315	889	1076	1280	1502	1742	2000	
21		37	77	117	157	197	237	277	317	933	1129	1344	1577	1829	2100	
22		39	79	119	159	199	239	279	319	978	1183	1408	1652	1916	2200	
23		41	81	121	161	201	241	281	321	1022	1237	1472	1728	2004	2300	
24	3	43	83	123	163	203	243	283	323	1067	1291	1536	1803	2091	2400	
25	4	44	84	124	164	204	244	284	324	1111	1344	1600	1878	2178	2500	

Shaded area represents S = L
Minimum length of vertical curve = 3 ft

Figure 5-8. Minimum Length of Crest Vertical Curve Based on Stopping Sight Distance

Metric

A	S = Stopping Sight Distance (m)																			
	(%)	10	15	20	25	30	35	40	45	50	55	60	65	70	75	80	85	90	95	100
2															10	20	30	40	50	60
3									7	17	27	37	47	57	67	77	87	97	107	
4						0	10	20	30	40	50	60	70	80	91	103	116	129	143	
5					4	14	24	34	44	54	64	75	88	100	114	129	145	161	179	
6				3	13	23	33	43	54	65	77	91	105	121	137	155	174	193	214	
7				10	20	30	40	51	63	76	90	106	123	141	160	181	203	226	250	
8			5	15	25	35	46	58	71	86	103	121	140	161	183	206	231	258	286	
9			9	19	29	39	51	65	80	97	116	136	158	181	206	232	260	290	321	
10		2	12	22	32	44	57	72	89	108	129	151	175	201	229	258	289	322	357	
11		5	15	25	35	48	63	80	98	119	141	166	193	221	251	284	318	355	393	
12		7	17	27	39	53	69	87	107	130	154	181	210	241	274	310	347	387	429	
13		8	18	29	42	57	74	94	116	140	167	196	228	261	297	335	376	419	464	
14		10	20	31	45	61	80	101	125	151	180	211	245	281	320	361	405	451	500	
15	1	11	21	33	48	66	86	108	134	162	193	226	263	301	343	387	434	483	536	
16	3	13	23	36	51	70	91	116	143	173	206	241	280	321	366	413	463	516	571	
17	4	14	24	38	55	74	97	123	152	184	219	257	298	342	389	439	492	548	607	
18	4	14	26	40	58	79	103	130	161	194	231	272	315	362	411	464	521	580	643	
19	5	15	27	42	61	83	109	137	170	205	244	287	333	382	434	490	550	612	679	
20	6	16	29	45	64	88	114	145	179	216	257	302	350	402	457	516	579	645	714	
21	7	17	30	47	68	92	120	152	188	227	270	317	368	422	480	542	608	677	750	
22	7	18	31	49	71	96	126	159	196	238	283	332	385	442	503	568	636	709	786	
23	8	18	33	51	74	101	131	166	205	248	296	347	403	462	526	593	665	741	821	
24	8	19	34	54	77	105	137	174	214	259	309	362	420	482	549	619	694	774	857	
25	9	20	36	56	80	109	143	181	223	270	321	377	438	502	571	645	723	806	893	

Shaded area represents S = L
Minimum length of vertical curve = 1 m

Figure 5-8. Minimum Length of Crest Vertical Curve Based on Stopping Sight Distance (continued)

Other path users such as child bicyclists, hand bicyclists, recumbent bicyclists, and others have lower eye heights than a typical adult bicyclist. Eye heights are approximately 2.6 ft (0.85 m) for hand bicyclists and 3.9 ft (1.2 m) for recumbent bicyclists. When compared to the eye heights of typical bicyclists, these lower eye heights limit sight distance over crest vertical curves. However, since most hand bicyclists and child bicyclists travel slower than typical adult bicyclists, their needs are met by using the values in Figure 5-8. Recumbent bicyclists generally travel faster than typical upright bicyclists, so if they are expected to make up a relatively large percentage of path users, crest vertical curve lengths should be increased accordingly (operating characteristics of recumbent bicyclists are found in Chapter 3).

Figures 5-9, 5-10, and Table 5-6 indicate the minimum clearance that should be used for line-of-sight obstructions for horizontal curves. The lateral clearance (horizontal sight line offset or HSO) is obtained by using the table in Figure 5-9 with the stopping sight distance (Figure 5-6) and the proposed horizontal radius of curvature.

Path users typically travel side-by-side on shared use paths. On narrow paths, bicyclists have a tendency to ride near the middle of the path. For these reasons, and because of the higher likeli-

hood for crashes on curves, lateral clearances on horizontal curves should be calculated based on the sum of the stopping sight distances for path users traveling in opposite directions around the curve. Where this is not practical, consideration should be given to widening the path through the curve, installing a yellow center line stripe, installing turn or curve warning signs (W1 series) in accordance with the MUTCD (7), or a combination of these alternatives. See Sections 5.4.1 and 5.4.2 for more information about center line pavement markings and signs.

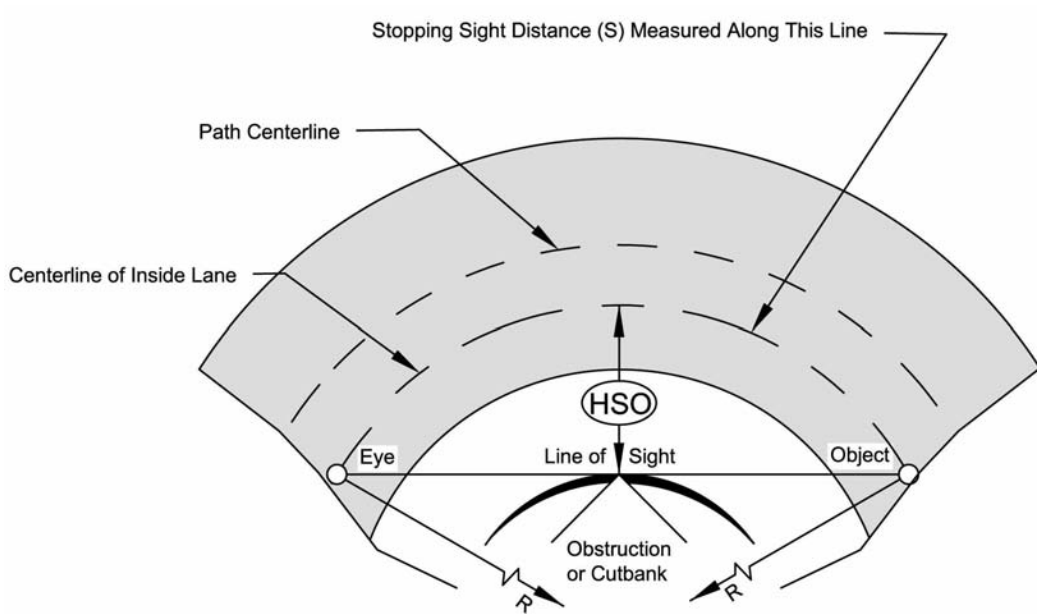

Figure 5-9. Diagram Illustrating Components for Determining Horizontal Sight Distance

Table 5-6. Horizontal Sight Distance

U.S. Customary			Metric		
$HSO = R \left[1 - \cos \left(\frac{28.65S}{R} \right) \right]$ $HSO = \frac{R}{28.65} \left[1 - \cos^{-1} \left(\frac{R - HSO}{R} \right) \right]$			$HSO = R \left[1 - \cos \left(\frac{28.65S}{R} \right) \right]$ $HSO = \frac{R}{28.65} \left[1 - \cos^{-1} \left(\frac{R - HSO}{R} \right) \right]$		
where:			where:		
S	=	stopping sight distance (ft)	S	=	stopping sight distance (m)
R	=	radius of centerline of lane (ft)	R	=	radius of centerline of lane (m)
HSO	=	horizontal sightline offset, distance from centerline of lane to obstruction (ft)	HSO	=	horizontal sightline offset, distance from centerline of lane to obstruction (m)
Note: Angle is expressed in degrees; line of sight is 2.3 ft above centerline of inside lane at point of obstruction.			Note: Angle is expressed in degrees; line of sight is 0.7 m above centerline of inside lane at point of obstruction.		

Guide to Bicycle Facilities, 4th Edition

U.S. Customary

S = Stopping Sight Distance (ft)

R (ft)	20	40	60	80	100	120	140	160	180	200	220	240	260	280	300
25	2.0	7.6	15.9												
50	1.0	3.9	8.7	15.2	23.0	31.9	41.5								
75	0.7	2.7	5.9	10.4	16.1	22.8	30.4	38.8	47.8	57.4	67.2				
95	0.5	2.1	4.7	8.3	12.9	18.3	24.7	31.8	39.5	48.0	56.9	66.3	75.9	85.8	
125	0.4	1.6	3.6	6.3	9.9	14.1	19.1	24.7	31.0	37.9	45.4	53.3	61.7	70.6	79.7
155	0.3	1.3	2.9	5.1	8.0	11.5	15.5	20.2	25.4	31.2	37.4	44.2	51.4	59.1	67.1
175	0.3	1.1	2.6	4.6	7.1	10.2	13.8	18.0	22.6	27.8	33.5	39.6	46.1	53.1	60.5
200	0.3	1.0	2.2	4.0	6.2	8.9	12.1	15.8	19.9	24.5	29.5	34.9	40.8	47.0	53.7
225	0.2	0.9	2.0	3.5	5.5	8.0	10.8	14.1	17.8	21.9	26.4	31.3	36.5	42.2	48.2
250	0.2	0.8	1.8	3.2	5.0	7.2	9.7	12.7	16.0	19.7	23.8	28.3	33.1	38.2	43.7
275	0.2	0.7	1.6	2.9	4.5	6.5	8.9	11.6	14.6	18.0	21.7	25.8	30.2	34.9	39.9
300	0.2	0.7	1.5	2.7	4.2	6.0	8.1	10.6	13.4	16.5	19.9	23.7	27.7	32.1	36.7
350	0.1	0.6	1.3	2.3	3.6	5.1	7.0	9.1	11.5	14.2	17.1	20.4	23.9	27.6	31.7
390	0.1	0.5	1.2	2.1	3.2	4.6	6.3	8.2	10.3	12.8	15.4	18.3	21.5	24.9	28.5
500	0.1	0.4	0.9	1.6	2.5	3.6	4.9	6.4	8.1	10.0	12.1	14.3	16.8	19.5	22.3
565		0.4	0.8	1.4	2.2	3.2	4.3	5.7	7.2	8.8	10.7	12.7	14.9	17.3	19.8
600		0.3	0.8	1.3	2.1	3.0	4.1	5.3	6.7	8.3	10.1	12.0	14.0	16.3	18.7
700		0.3	0.6	1.1	1.8	2.6	3.5	4.6	5.8	7.1	8.6	10.3	12.0	14.0	16.0
800		0.3	0.6	1.0	1.6	2.2	3.1	4.0	5.1	6.2	7.6	9.0	10.5	12.2	14.0
900		0.2	0.5	0.9	1.4	2.0	2.7	3.6	4.5	5.6	6.7	8.0	9.4	10.9	12.5
1000		0.2	0.5	0.8	1.3	1.8	2.4	3.2	4.0	5.0	6.0	7.2	8.4	9.8	11.2

Metric

S = Stopping Sight Distance (m)

R (m)	10	15	20	25	30	35	40	45	50	55	60	65	70	75	80	85	90	95	100
10	1.2	2.7	4.6	6.8	9.3														
15	0.8	1.8	3.2	4.9	6.9	9.1	11.0	14.0											
20	0.6	1.4	2.4	3.8	5.4	7.2	9.2	11.0	14.0	16.0	19.0								
25	0.5	1.1	2.0	3.1	4.4	5.9	7.6	9.5	11.0	14.0	16.0	18.0	21.0	23.0					
50	0.3	0.6	1.0	1.6	2.2	3.0	3.9	5.0	6.1	7.4	8.7	10.0	12.0	13.0	15.0	17.0	19.0	21.0	23.0
75	0.2	0.4	0.7	1.0	1.5	2.0	2.7	3.4	4.1	5.0	5.9	6.9	8.0	9.2	10.0	12.0	13.0	15.0	16.0
100	0.1	0.3	0.5	0.8	1.1	1.5	2.0	2.5	3.1	3.8	4.5	5.2	6.1	7.0	7.9	8.9	10.0	11.0	12.0
125	0.1	0.2	0.4	0.6	0.9	1.2	1.6	2.0	2.5	3.0	3.6	4.2	4.9	5.6	6.3	7.2	8.0	8.9	9.9
150		0.2	0.3	0.5	0.7	1.0	1.3	1.7	2.1	2.5	3.0	3.5	4.1	4.7	5.3	6.0	6.7	7.5	8.3
175		0.2	0.3	0.4	0.6	0.9	1.1	1.4	1.8	2.2	2.6	3.0	3.5	4.0	4.6	5.1	5.8	6.4	7.1
200		0.1	0.3	0.4	0.6	0.8	1.0	1.3	1.6	1.9	2.2	2.6	3.1	3.5	4.0	4.5	5.0	5.6	6.2
225		0.1	0.2	0.3	0.5	0.7	0.9	1.1	1.4	1.7	2.0	2.3	2.7	3.1	3.5	4.0	4.5	5.0	5.5
250		0.1	0.2	0.3	0.5	0.6	0.8	1.0	1.2	1.5	1.8	2.1	2.4	2.8	3.2	3.6	4.0	4.5	5.0
275		0.1	0.2	0.3	0.4	0.6	0.7	0.9	1.1	1.4	1.6	1.9	2.2	2.6	2.9	3.3	3.7	4.1	4.5
300			0.2	0.3	0.4	0.5	0.7	0.8	1.0	1.3	1.5	1.8	2.0	2.3	2.7	3.0	3.4	3.8	4.2

Figure 5-10. Minimum Lateral Clearance (Horizontal Sightline Offset or HSO) for Horizontal Curves

5.2.9 Surface Structure

Hard, all-weather pavement surfaces are generally preferred over those of crushed aggregate, sand, clay, or stabilized earth. Since unpaved surfaces provide a lower level of service, it may cause bicyclists to more easily lose traction (particularly bicycles with narrower, higher-pressure tires), and may need more maintenance. On unpaved surfaces, bicyclists and other wheeled users must use a greater effort to travel at a given speed when compared to a paved surface. Some users, such as inline skaters, are unable to use unpaved paths. In areas that experience frequent or even occasional flooding or drainage problems, or in areas of moderate or steep terrain, unpaved surfaces will often erode and are not recommended. Additionally, unpaved paths are difficult to plow for use during the winter.

Unpaved surfaces may be appropriate on rural paths, where the intended use of the path is primarily recreational, or as a temporary measure to open a path before funding is available for paving. Unpaved pathways should be constructed of materials that are firm and stable. Possible surfaces for unpaved paths include crushed stone, stabilized earth, and limestone screenings, depending upon local availability.

Asphalt or Portland cement concrete provides good quality, all-weather pavement structures. Advantages of Portland cement concrete include longer service life, reduced susceptibility to cracking and deformation from roots and weeds, and a more consistent riding surface after years of use and exposure to the elements. On Portland cement concrete pavements, transverse joints can be cut with a saw to provide a smooth ride. A disadvantage of Portland cement concrete pavements is that pavement markings (such as centerlines) can have a lower contrast against the concrete surface; markings typically have a higher contrast on an asphalt surface, particularly at night.

Advantages of asphalt include a smooth rolled surface when new, and lower construction costs than with concrete. Asphalt surfaces are softer and are therefore preferred by runners and walkers over concrete. However, asphalt pavement is less durable (typical life expectancy is 15–20 years) and needs more interim maintenance.

Because of wide variations in soils, loads, materials, and construction practices, and varying costs of pavement materials, it is not practical to recommend typical structural sections that will be applicable nationwide. However, the total pavement depth should typically be a minimum of 6 in. (150 mm), inclusive of the surface course (asphalt or Portland cement concrete) and the base course (typically an aggregate rock base). Any pavement section should be placed over a compacted subgrade.

Designing and selecting pavement sections for shared use paths is similar to designing and selecting highway pavement sections. A soils investigation should be conducted to determine the load-carrying capabilities of the native soil, or former railroad bed (if ballast has been removed), and the need for any special treatments. A soils investigation should also be conducted to determine whether subsurface drainage may be applicable. In colder climates, the effects of freeze-thaw cycles should be anticipated. Geotextiles and other similar materials should be considered where subsurface conditions warrant, such as in locations with swelling clay subgrade. Experience in roadway pavement design, together with sound engineering judgment, can assist in the selection and design of a proper path pavement structure and may identify energy-conserving practices, such as the use of sulfur-extended asphalt, asphalt emulsions, porous pavement, and recycled asphalt.

While loads on shared use paths will be substantially less than roadways, paths should be designed to sustain wheel loads of occasional emergency, patrol, maintenance, and other motor vehicles that are expected to use or cross the path. When motor vehicles are driven on shared use paths, their wheels often will be at, or very near, the edges of the path. This can cause edge damage that, in turn, will reduce the effective operating width of the path. The path should, therefore, be constructed of sufficient width to accommodate the vehicles, and adequate edge support should be provided. Edge support can be provided by means of stabilized shoulders, flush or raised concrete curbing, or additional pavement width or thickness. The use of flush concrete curbing has other long-term maintenance benefits, such as reducing the potential for encroachment of vegetation onto the path surface. If raised curbs are used, one foot of additional path width should be provided, as users will shy away from the curb, resulting in a narrower effective path width.

It is important to construct and maintain a smooth riding surface on shared use paths. Pavements should be machine laid; soil sterilizers should be used where needed to prevent vegetation from erupting through the pavement. On Portland cement concrete pavements, the transverse joints needed to control cracking should be saw cut, rather than tooled, to provide a smoother ride. On the other hand, skid resistance qualities should not be sacrificed for the sake of smoothness. Broom finish or burlap drag concrete surfaces are preferred.

Utility covers (i.e., manholes) and bicycle-compatible drainage grates should be flush with the surface of the pavement on all sides. Preferably, manhole covers and drainage grates would be located to the side of the paths so when work needs to be performed, the path would not need to be closed. Railroad crossings should be smooth and be designed at an angle between 60 and 90 degrees to the direction of travel in order to minimize the possibility of falls. Refer to Chapter 4 for design treatments that can be used to improve railroad crossings.

Where a shared use path crosses an unpaved road or driveway, the road or driveway should be paved a minimum of 20 ft (6 m) on each side of the crossing to reduce the amount of gravel scattered onto or along the path by motor vehicles. The pavement structure at the crossing should be adequate to sustain the expected loading at that location.

5.2.10 Bridges and Underpasses

A bridge or underpass may be needed to provide continuity to a shared use path. The “receiving” clear width on the end of a bridge (from inside of rail or barrier to inside of opposite rail or barrier) should allow 2 ft (0.6 m) of clearance on each side of the pathway, as recommended in Section 5.2.1, but under constrained conditions may taper to the pathway width.

Carrying the clear areas across the structures has two advantages. First, the clear width provides a minimum horizontal shy distance from the railing or barrier, and second, it provides needed maneuvering space to avoid conflicts with pedestrians or bicyclists who have stopped on the bridge (e.g., to admire the view).

Access by emergency, patrol, and maintenance vehicles should be considered in establishing design clearances of structures on shared use paths. Similarly, vertical clearance may be dictated by occasional authorized motor vehicles using the path. A minimum vertical clearance of 10 ft (3.0 m) is desirable for adequate vertical shy distance.

At transitions and approaches from paths to bridge decks, the height of the path’s surface should match the height of the bridge deck surface so as to provide a smooth transition between path-

way and bridge deck. Bridge deck lips, formed by differences between pathway and bridge deck heights, should be avoided because they can cause tire blowouts, bent wheels, crashes, and injuries. These lips can be eliminated by placing a transitional layer of asphalt between the path surface and the bridge deck.

Where grade separation is desired between a path and a roadway or railroad, designers sometimes have the choice between constructing a bridge over the roadway or railroad, and constructing a tunnel or underpass under the roadway or railroad. The adjacent topography typically is the greatest factor in determining which option is best; however, bridges are preferred to underpasses because they have security advantages and are less likely to have drainage problems.

When a bridge or underpass is built over a public right-of-way (such as a road), a connection is often needed between the path and roadway; as this represents a potential access point for pedestrians and bicyclists. This often involves significant ramping or other means to provide an accessible connection between the two.

Protective railings, fences, or barriers on either side of a shared use path on a stand-alone structure should be a minimum of 42 in. (1.05 m) high. There are some locations where a 48-in. (1.2 m) high railing should be considered in order to prevent bicyclists from falling over the railing during a crash. This includes bridges or bridge approaches where high-speed, steep-angle (25 degrees or greater) impacts between a bicyclist and the railing may occur, such as at a curve at the foot of a long, descending grade where the curve radius is less than that appropriate for the design speed or anticipated speed.

Openings between horizontal or vertical members on railings should be small enough that a 6 in. (150 mm) sphere cannot pass through them in the lower 27 in. (0.7 m). For the portion of railing that is higher than 27 in. (0.7 m), openings may be spaced such that an 8 in. (200 mm) sphere cannot pass through them. This is done to prevent children from falling through the openings. Where a bicyclist's handlebar may come into contact with a railing or barrier, a smooth, wide rub-rail may be installed at a height of about 36 in. (0.9 m) to 44 in. (1.1 m), to reduce the likelihood that a bicyclist's handlebar will be caught by the railing (see Figure 5-11).

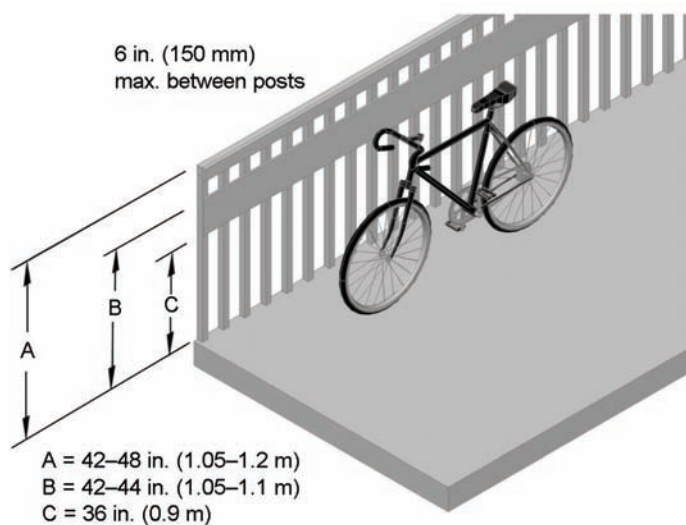

Figure 5-11. Bridge Railing

Bridges should be designed for pedestrian live loadings. Where maintenance and emergency vehicles may be expected to cross the bridge, the design should accommodate them. On all bridge decks, special care should be taken that bicycle-compatible expansion joints are used, and that decking materials are not slippery when wet. There are often opportunities to retrofit path structures to existing highway or railroad bridges. Using an existing bridge can result in significant cost



Figure 5-12. Example of Bridge Structures (Photo courtesy of Jennifer Toole of Toole Design Group.)

savings and provide path continuity over large rivers and other obstacles. These retrofits can be accomplished in several ways, including cantilevering the path onto an existing bridge, or by placing the path within the substructure of the existing bridge, as shown in Figure 5-12.

In many situations, there is a desire to retrofit a path under a bridge along a river or waterway to provide a grade-separated crossing of a major road or railroad. Special treatments may be needed in these circumstances. These paths are often located within a floodplain, so path pavement and subgrade treatments may need to be enhanced. In extreme cases, paths can be built below the normal water level, such that the water would need to be retained

and a pumping system would need to be provided for the path. The structural design of bridges for shared use paths (e.g., railings) should be designed in accordance with the AASHTO *LRFD Bridge Design Specifications (1)* and the *Guide Specifications for Design of Pedestrian Bridges (3)*. The technical provisions in this manual either meet or exceed those recommended in the current versions of these respective specifications.

5.2.11 Drainage

The minimum recommended pavement cross slope of 1 percent usually provides adequate drainage. Sloping in one direction instead of crowning is preferred and usually simplifies drainage and surface construction. An even surface is essential to prevent water ponding and ice formation. On unpaved shared use paths, particular attention should be paid to drainage to avoid erosion.

Depending on site conditions, typically paths with cross slope in the direction of the existing terrain will provide sheet flow of surface runoff and avoid the need for channelizing flow in ditches, cross culverts, and closed pipe systems. However, where a shared use path is constructed on the side of a slope that has considerable runoff, or other conditions that result in relatively high runoff, a ditch of suitable dimensions should be placed on the uphill side to intercept the slope's drainage. Such ditches should be designed so that the potential for injury to errant bicyclists is limited. Where needed, catch basins with drains should be provided to carry the intercepted water under the path. Bicycle-compatible drainage grates and manhole covers should be located to the side of the pathway.

Paths that are located in low-lying areas may need attention to other drainage issues in the vicinity that have not been previously addressed so that the path drains properly, and that retention areas located away from the pathway are provided.

To prevent erosion in the area adjacent to the shared use path, consideration should be given to preserving a hardy, natural ground cover. In addition, pathway design should meet applicable storm water management regulations. In an effort to improve water quality and manage the quantity of runoff, low-impact development techniques such as bio-retention swales should be considered. Other erosion and sediment control measures should be employed as needed, including seeding, mulching, and sodding of adjacent slopes, swales, and other erodible areas.

5.2.12 Lighting

Fixed-source lighting can improve visibility along paths and at intersections at night or under other dark conditions. Lighting can also greatly improve riders' ability to detect surface discontinuities under such conditions, even when their bicycles are properly equipped with headlamps. Provision of lighting should be considered where nighttime usage is not prohibited, and especially on paths that provide convenient connections to transit stops and stations, schools, universities, shopping, and employment areas.

Where nighttime use is permitted, pathway lighting is recommended at path–roadway intersections. If nighttime use is prohibited, lighting at crosswalks should still be considered if the pathway connects to existing sidewalks, because the crossing is in the public right-of-way and may be used at night even if the pathway is not. Lighting should also be considered in locations where personal security is an issue.

Pedestrian-scale lighting is preferred to tall, highway-style lamps. Pedestrian-scale lighting is characterized by shorter light poles (standards about 15 ft [4.6 m] high), lower levels of illumination (except at crossings), closer spacing of standards (to avoid dark zones between luminaires), and high pressure sodium vapor or metal halide lamps. Metal halide lamps produce better color rendition (“white light”) than sodium vapor lamps and can facilitate user recognition in areas with high volumes of night use. Depending on the location, average maintained horizontal illumination levels of 0.5 to 2-foot candles (5 to 22 lux) should be considered. For personal safety, higher lighting levels may be needed in some locations.

Placement of light poles should provide the recommended horizontal and vertical clearances from the pathway. Light fixtures should be chosen to reduce the loss of light and may need to comply with local “dark sky” guidelines and regulations. The use of solar-powered lighting can be considered; however, care should be taken that the installation provides adequate light. Solar-powered lighting is often inadequate in locations with significant tree canopy, or in northern regions where it sometimes fails to provide enough illumination during winter months.

If a pathway is used infrequently at night, lighting can be provided at certain hours only, based on an engineering study of pathway usage; for example, up to 11:00 p.m. and starting at 6:00 a.m. These conditions should be made known to path users with a sign at path entrances. Where lighting is not provided, or only provided during certain hours, reflective edge lines should be provided as described in Section 5.4.1.

Lighting should be provided in pathway tunnels and underpasses. At night, lighting in tunnels is important to provide security. Daytime lighting of tunnels and underpasses is often needed,

and should be designed in a manner similar to the design of lighting in roadway tunnels. This includes brighter lighting during the day than at night, due to the fact that users' eyes cannot make fast adjustments to changing light conditions. On long tunnels it is appropriate to use varying light intensities through the tunnel, with higher levels of illumination near the entrances and lower levels in the middle. Refer to the *Roadway Lighting Design Guide* (5) for more information about designing appropriate lighting in tunnels and underpasses.

5.3 SHARED USE PATH–ROADWAY INTERSECTION DESIGN

The design of intersections between shared use paths and roadways has a significant impact on users' comfort and mobility. Intersection design should not only address cross-traffic movements, but should also address turning movements of riders entering and exiting the path. Due to potential conflicts at these junctions, careful design should be used for predictable and orderly operation between shared use path traffic and other traffic.

Regardless of whether a pathway crosses a roadway at an existing intersection between two roadways, or at a new “mid-block” location, the principles that apply to design for pedestrians at crossings (controlled and uncontrolled) are also applicable to pathway–intersection design. There are a wide range of design features that have the likelihood to reduce pedestrian and bicyclist crashes at such intersections. This guide provides a general overview of crossing measures; other sources, such as AASHTO's *Guide for the Planning, Design, and Operation of Pedestrian Facilities* (2), should be consulted for more detail.

Shared use path crossings come in many configurations with many variables: the number of roadway lanes to be crossed; divided or undivided roadways, number of approach legs; the speeds and volumes of traffic; and traffic controls that range from uncontrolled to yield-, stop-, or signal-controlled. Each intersection is unique and needs engineering judgment to determine an appropriate intersection treatment.

Due to the mixed nature of shared use path traffic, the practitioner should keep in mind the speed variability of each travel mode and its resulting effect on design values when considering design treatments for path–roadway intersections. The fastest vehicle should be considered for approach speeds (typically the bicyclist and motor vehicle) as these modes are the most likely to surprise cross traffic at the intersection. By contrast, for departures from a stopped condition, the characteristics of slower path users (typically pedestrians) should be taken into account due to their greater exposure to cross traffic. Intersections between pathways and roadways should be designed to be accessible to all users, as stated in Section 5.1.1.

5.3.1 Shared Use Path Crossing Types

Shared use path crossings can be broadly categorized as mid-block, sidepath, or grade-separated crossings. A crossing is considered mid-block if it is located outside of the functional area of any adjacent intersection. In some respects, a mid-block shared use path crossing can be considered as a four-leg intersection. A sidepath crossing occurs within the functional area of an intersection of two or more roadways (see Figure 5-13). Sidepath crossings are typically parallel to at least one roadway. Sidepath intersections have unique operational challenges that are similar to those of parallel frontage roadways. Section 5.2.2 covers these operational issues in detail.

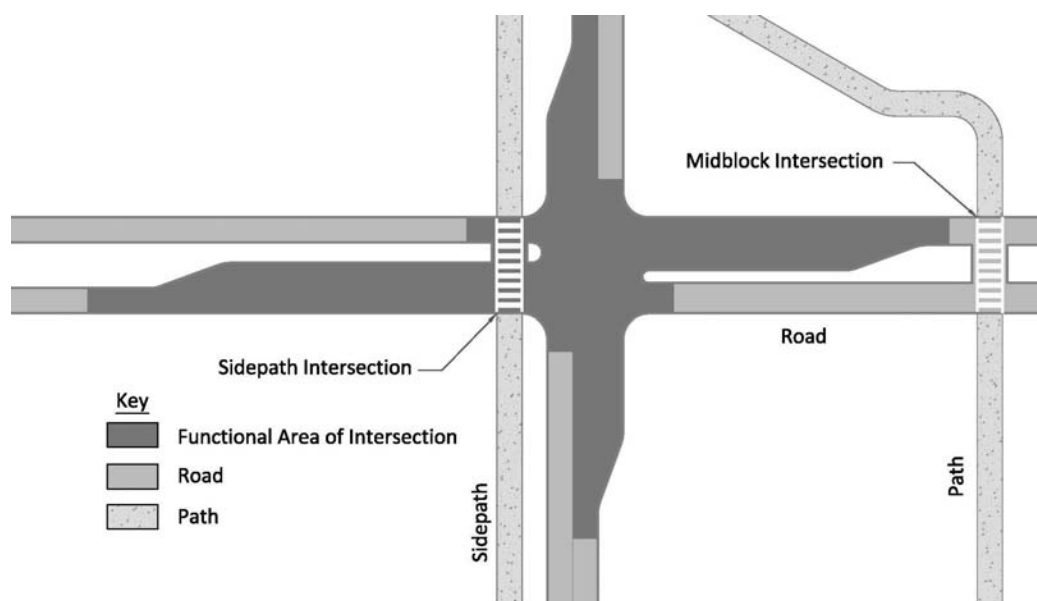

Figure 5-13. Mid-Block and Sidepath Crossings Relative to Intersection Functional Area

In some locations, roadway or path traffic conditions may warrant consideration of a grade-separated crossing consisting of either a bridge over the roadway or an underpass beneath the roadway. An analysis should be made to assess the demand for and viability of a grade-separated crossing. See Section 5.2.10 and the discussion of grade-separated crossings in the *AASHTO Guide for the Planning, Design, and Operation of Pedestrian Facilities (2)*.

5.3.2 Design of Mid-Block Crossings

The task of designing a mid-block crossing between a pathway and a roadway involves a number of variables, including anticipated mix and volume of path users, the speed and volume of motor vehicle traffic on the roadway being crossed, the configuration of the road, the amount of sight distance that can be achieved at the crossing location, and other factors. Geometric design features and traffic controls should be used in combination to effectively accommodate all users.

Geometric Design Issues at Crossings

The design approach for the intersection of a shared use path with a roadway is similar to the design approach used for the intersection of two roadways in the following ways:

- The intersection should be conspicuous to both road users and path users.
- Sight lines should be maintained to meet the needs of the traffic control provided.
- Intersections and approaches should be on relatively flat grades.
- Intersections should be as close to a right angle as practical, given the existing conditions.

- The least traffic control that is effective should be selected.
- Intersections should be sufficiently spaced to be outside the functional area of adjacent intersections (see Figure 5-13).

It is preferable for mid-block path crossings to intersect the roadway at an angle as close to perpendicular as practical, so as to minimize the exposure of crossing path users and maximize sight lines. A crossing skewed at 30 degrees is twice as long as a perpendicular crossing, doubling the exposure of path users to approaching motor vehicles, and increasing delays for motorists who must wait for path users to cross. Retrofitting skewed path crossings can reduce the roadway exposure for path users. Figure 5-14 depicts a path realignment to achieve a 90-degree crossing. A minimum 60-degree crossing angle may be acceptable to minimize right-of-way needs (12).

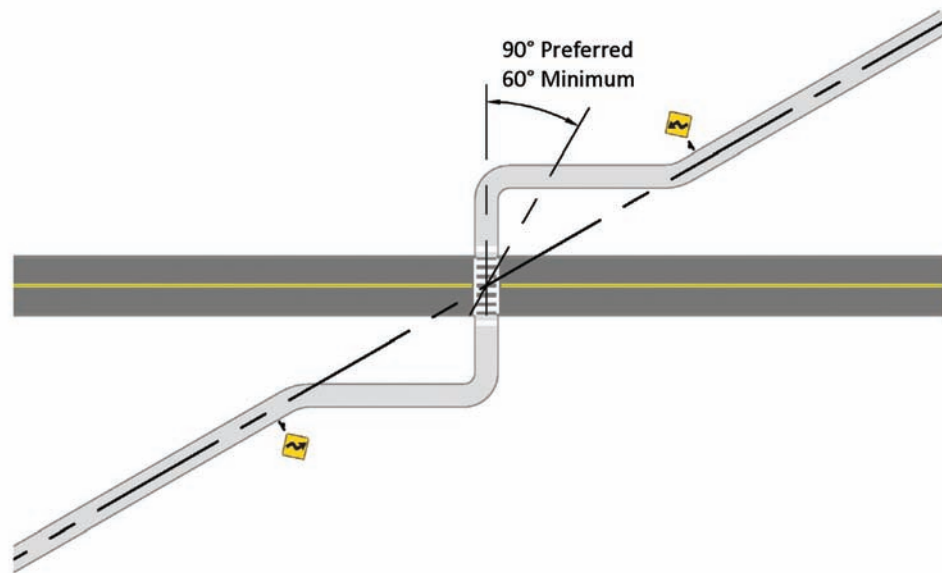

Figure 5-14. Crossing Angle

Special Issues with Assignment of Right of Way

Shared use paths are unique in terms of the assignment of the right of way, due to the legal responsibility of drivers to yield to (or stop for) pedestrians in crosswalks. Most state codes also stipulate that a pedestrian may not suddenly leave any curb (or refuge area) and walk or run into the path of a vehicle that is so close that it is impossible for the driver to yield. The result is a mutual yielding responsibility among motor vehicle drivers and pedestrians, depending upon the timing of their arrival at an intersection. Some states extend the rights and responsibilities of pedestrians at crosswalks to bicyclists as well, while other states do not. When designing intersections of shared use paths, designers should understand the laws within their state regarding assignment of right of way for pedestrians and bicyclists (and other path users).

When assigning right of way, the speed differential between bicyclists and pedestrians on the pathway should also be taken into account. Bicyclists approach the intersection at a far greater speed than pedestrians, and they desire to maintain their speed as much as practical. The result may be the need to remind bicyclists of their responsibility to yield or stop, while not confusing the issue of who has the legal right of way at mid-block crossings.

Given these complexities, the most prudent approach when determining the appropriate design and control measures at mid-block pathway intersections is to first determine what measures might likely reduce pedestrian crashes or improve access (as described below), as it may be determined through this process that a pedestrian signal or beacon is needed. If a signal or a beacon is not needed, the next step is to determine clear sight triangles on the major and minor approaches, so as to evaluate applicability of yield control on the minor approach. Engineering judgment should be applied.

Determining Appropriate Crossing Measures

Pedestrians amount to a substantial share of users on most paths and experience the greatest amount of exposure at intersections. Uncontrolled pathway crossings should be designed to accommodate pedestrians, while also taking into consideration measures tailored to the operational characteristics of bicyclists and other path users.

High-visibility marked crosswalks are recommended at uncontrolled path–roadway intersections. On roadways with low traffic volumes and speeds where sight distances are adequate, the marked crosswalk should be sufficient to accommodate pedestrians effectively. It is recommended that a minimum of 20 pedestrian crossings (or 15 or more elderly and/or child pedestrians) per peak hour exist at a location before placing a high priority on installing a marked crosswalk alone. Additional crossing measures (such as reducing traffic speeds, shortening crossing distance, enhancing driver awareness of the crossing, and/or providing active warning of crosswalk user presence) are recommended at uncontrolled locations where the speed limit exceeds 40 mph (64 km/h) and either:

- The roadway has four or more lanes of travel without a raised crossing island and an ADT of 12,000 vehicles per day or greater; or
- The roadway has four or more lanes of travel with a raised crossing island (either existing or planned) and an ADT of 15,000 vehicles per day or greater (17).

Use of marked crosswalks should be consistent with guidance provided in the MUTCD (7).

Determining Priority Assignment

In conventional roadway intersection design, right of way is assigned to the higher volume and/or higher speed approach. In the case of a path–roadway intersection, user volumes on the path should be considered. While in many cases roadways will have greater volumes, user volumes on popular paths sometimes exceed traffic volumes on minor crossed streets. In such situations, total user delay may be minimized if roadway traffic yields to path traffic, and given bicyclists' reluctance to lose momentum, such an operating pattern often develops spontaneously. In such situations, “YIELD” or “STOP” control is more appropriately applied on the roadway approaches (given an analysis of speeds, sight distances, and so forth as described below).

Changes in user volumes over time should also be considered. New shared use paths are often built in segments, resulting in low initial volumes. In that case, assignment of priority to roadway traffic is usually appropriate. However, path volumes may increase over time, raising the need to re-examine priority assignment. Traffic flows at path–roadway intersections should be reviewed occasionally to confirm that the priority assignment remains appropriate.

Use of Stop Signs

Application of intersection controls (“YIELD” signs, “STOP” signs, or traffic signals) should follow the principle of providing the least amount of restriction that is effective. Installing unwarranted or unrealistically restrictive controls on path approaches in an attempt to “protect” path users can result in path users disregarding the signs and other traffic control devices at the intersection. This can lead to a loss of respect for traffic control at more critical locations.

A common misconception is that the routine installation of stop control for the pathway is an effective treatment for preventing crashes at path–roadway intersections. Poor bicyclist compliance with “STOP” signs at path–roadway intersections is well documented. Bicyclists tend to operate as though there are “YIELD” signs at these locations: they slow down as they approach the intersection, look for oncoming traffic, and proceed with the crossing if it is safe to do so. “YIELD” control (either for vehicular traffic on the roadway or for users on the pathway) can therefore be an effective solution at some mid-block crossings, as it encourages caution without being overly restrictive.

Evaluating Sight Distance to Select Type of Control

Intersection sight distance (sight triangles) is a fundamental component in selecting the appropriate control at a mid-block path–roadway intersection. As described above, the least restrictive control that is effective should be used. As noted in the horizontal sight distance equation (Table 5-6), the line of sight is considered to be 2.3 ft (0.7 m) above the roadway or path surface. Roadway approach sight distance and departure sight triangles should be calculated in accordance with procedures detailed in AASHTO’s *A Policy on Geometric Design of Highways and Streets* (4), as motor vehicles will control the design criteria.

Generally, pathway approach sight distance should be calculated utilizing the fastest typical path user, which in most cases is the adult two-wheeled bicyclist. Under certain conditions it may be desirable to use a different design user (and therefore a different approach speed) if they are more prevalent and represent a faster value. Ideally, approach sight triangles provide an unobstructed view of the entire intersection and a sufficient amount of the intersecting facility to anticipate and avoid a potential collision with crossing traffic, regardless of the traffic control. Approaches to uncontrolled and yield-controlled intersections should provide the recommended approach sight triangle, or else a more restrictive control should be considered.

Approach sight triangles depend on the design speeds of both the path and the roadway. If yield control is to be used for either the roadway approach or the path approach, it is desirable that available sight distance be adequate for a traveler on the yield-controlled approach to slow, stop, and to avoid a traveler on the other approach. The roadway leg of the sight triangle is based on bicyclists’ ability to reach and cross the roadway if they do not see a potentially conflicting vehicle approaching on the roadway, and have just passed the point where they can execute a stop without entering the intersection (see Figure 5-15 and Table 5-7). See Table 5-4 and Figures 5-6 and 5-7 for bicyclist stopping sight distance. Similar to the roadway approach, the path leg of the sight triangle is based on motorists’ ability to reach and cross the junction if they do not see a potentially conflicting path user approaching, and have passed the point where they can execute a stop without entering the intersection. The length along the path leg of each approach is given in Table 5-8. If this yield sight triangle is not available, a more restrictive control may be appropriate.

Chapter 5: Design of Shared Use Paths

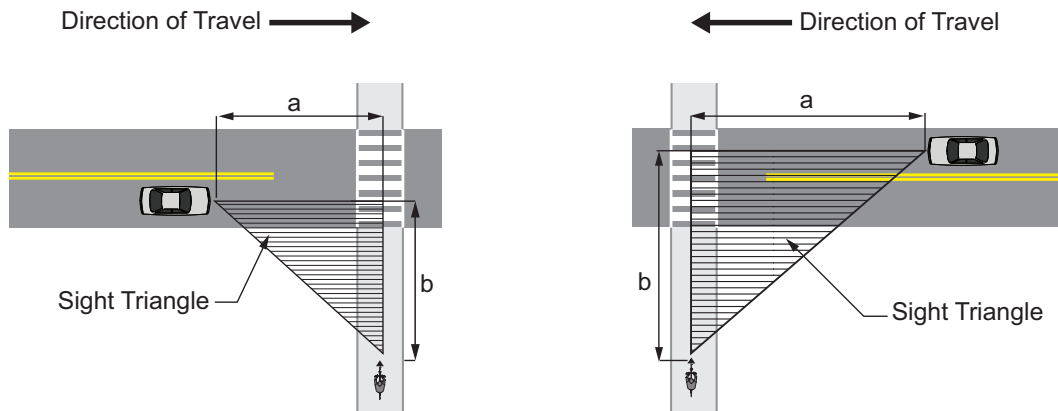

Figure 5-15. Yield Sight Triangles

Table 5-7. Length of Roadway Leg of Sight Triangle

U.S. Customary		Metric	
$t_a = \frac{S}{1.47V_{path}}$		$t_a = \frac{S}{0.278V_{path}}$	
$t_g = t_a + \frac{w + L_a}{1.47V_{path}}$		$t_g = t_a + \frac{w + L_a}{0.278V_{path}}$	
$a = 1.47V_{road}t_g$		$a = 0.278V_{road}t_g$	
where:			
t_g	=	travel time to reach and clear the road (s)	
a	=	length of leg sight triangle along the roadway approach (ft)	
t_a	=	travel time to reach the road from the decision point for a path user that doesn't stop (s)	
w	=	width of the intersection to be crossed (ft)	
L_a	=	typical bicycle length = 6 ft (see Chapter 3 for other design users)	
V_{path}	=	design speed of the path (mph)	
V_{road}	=	design speed of the road (mph)	
S	=	stopping sight distance for the path user traveling at design speed (ft)	
t_g	=	travel time to reach and clear the road (s)	
a	=	length of leg sight triangle along the roadway approach (m)	
t_a	=	travel time to reach the road from the decision point for a path user that doesn't stop (s)	
w	=	width of the intersection to be crossed (m)	
L_a	=	typical bicycle length = 1.8 m (see Chapter 3 for other design users)	
V_{path}	=	design speed of the path (km/h)	
V_{road}	=	design speed of the road (km/h)	
S	=	stopping sight distance for the path user traveling at design speed (m)	

Table 5-8. Length of Path Leg of Sight Triangle

U.S. Customary		Metric			
$t_a = \frac{1.47V_e - 1.47V_b}{a_i}$ $t_g = t_a + \frac{w + L_a}{0.88V_{road}}$ $b = 1.47V_{path}t_g$		$t_a = \frac{0.278V_e - 0.278V_b}{a_i}$ $t_g = t_a + \frac{w + L_a}{0.167V_{road}}$ $b = 0.278V_{path}t_g$			
where:		where:			
t_g	=	travel time to reach and clear the path (s)	t_g	=	travel time to reach and clear the path (s)
b	=	length of leg sight triangle along the path approach (ft)	b	=	length of leg sight triangle along the path approach (m)
t_a	=	travel time to reach the path from the decision point for a motorist that doesn't stop (s). For road approach grades that exceed 3 percent, value should be adjusted in accordance with AASHTO's <i>A Policy on Geometric Design of Highways and Streets</i> (5)	t_a	=	travel time to reach the path from the decision point for a motorist that doesn't stop (s). For road approach grades that exceed 3 percent, value should be adjusted in accordance with AASHTO's <i>A Policy on Geometric Design of Highways and Streets</i> (5)
V_e	=	speed at which the motorist would enter the intersection after decelerating (mph) (assumed $0.60 \times$ road design speed)	V_e	=	speed at which the motorist would enter the intersection after decelerating (km/h) (assumed $0.60 \times$ road design speed)
V_b	=	speed at which braking by the motorist begins (mph) (same as road design speed)	V_b	=	speed at which braking by the motorist begins (km/h) (same as road design speed)
a_i	=	motorist deceleration rate (ft/s^2) in intersection approach when braking to a stop not initiated (assume -5.0 ft/s^2)	a_i	=	motorist deceleration rate (m/s^2) in intersection approach when braking to a stop not initiated (assume -1.5 m/s^2)
w	=	width of the intersection to be crossed (ft)	w	=	width of the intersection to be crossed (m)
L_a	=	length of the design vehicle (ft)	L_a	=	length of the design vehicle (m)
V_{path}	=	design speed of the path (mph)	V_{path}	=	design speed of the path (km/h)
V_{road}	=	design speed of the road (mph)	V_{road}	=	design speed of the road (km/h)

Note: This table accounts for reduced motor vehicle speeds per standard practice in AASHTO's *A Policy on Geometric Design of Highways and Streets* (5).

Determining sufficient stop- and signal-controlled approach sight distance is simpler than yield-controlled. Regardless of which approach has stop-control or whether the intersection is signal-controlled, the roadway and path approaches to an intersection should always provide enough stopping sight distance to obey the control, and execute a stop before entering the intersection.

Departure sight distance for the path should be based on the slowest user who will have the most exposure to crossing traffic. This is typically the pedestrian. However, because path crossings function as legal crosswalks for pedestrians (and in some states for bicyclists), a key sight distance consideration is stopping sight distance for the roadway approach to provide adequate distance for the motor vehicle to stop if the path user is either already in the crosswalk, or is just beginning to enter it. Ideally, departure sight distance provides stopped pathway users with enough sight distance of the intersecting roadway to judge adequate gaps in oncoming traffic to cross the road. This type of departure sight distance is desirable for yield- and stop-controlled path approaches. Under certain conditions it may be desirable to use a different design user (and therefore different departure speed) if they are more prevalent and represent a slower value. Regardless of intersection sight triangle lengths, roadway and path approaches to an intersection should provide sufficient stopping sight distance so that motorists and bicyclists can avoid obstacles or potential conflicts within the intersection.

At an intersection of a shared use path with a walkway, a clear sight triangle extending at least 15 ft (4.6 m) along the walkway should be provided (see Figure 5-16). The clear sight line will enable pedestrians approaching the pathway to see and react to oncoming path traffic to avoid potential conflicts at the path-walkway intersection. If a shared use path intersects another shared use path, sight triangles should be provided similar to a yield condition at a path–roadway intersection. However, both legs of the sight triangle should be based on the stopping sight distance of the paths. Use the equation in Table 5-7 for both legs of the sight triangle.

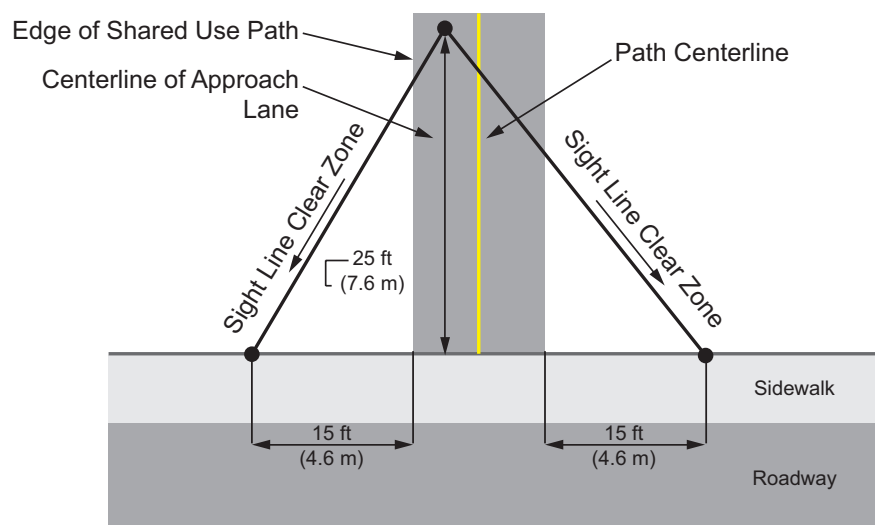

Figure 5-16. Minimum Path-Walkway Sight Triangle

Mid-Block Signalized Intersections

If traffic and roadway characteristics make crossing difficult for the path user, the need for a signal or active warning device (such as a beacon) should be considered based on traffic volumes, speed, number of lanes, and availability of a refuge. Guidance on the need for a signal and other traffic control devices is provided in the MUTCD (7) and in other sources such as FHWA's *Safety Effects of Marked Versus Unmarked Crosswalks at Uncontrolled Locations: Final Report and Recommended Guidelines* (18). Path user volumes may be used to determine the need for a signal and/or other active warning devices. In some situations when considering path user volume, it may be appropriate to assess whether the path users have access to another appropriate crossing location. More information on signals at path–roadway intersections is provided in Section 5.4.3.

5.3.3 Examples of Mid-Block Intersection Controls

Figures 5-17, 5-18, 5-19, and 5-20 illustrate various examples of mid-block control treatments. They show typical pavement marking and sign crossing treatments. These diagrams are illustrative and are not intended to show all signs and markings that may be necessary or advisable, or all types of design treatments that are possible at these locations. Each graphic assumes the appropriate minimum sight distances that are provided for the roadway and the path.

Chapter 5: Design of Shared Use Paths

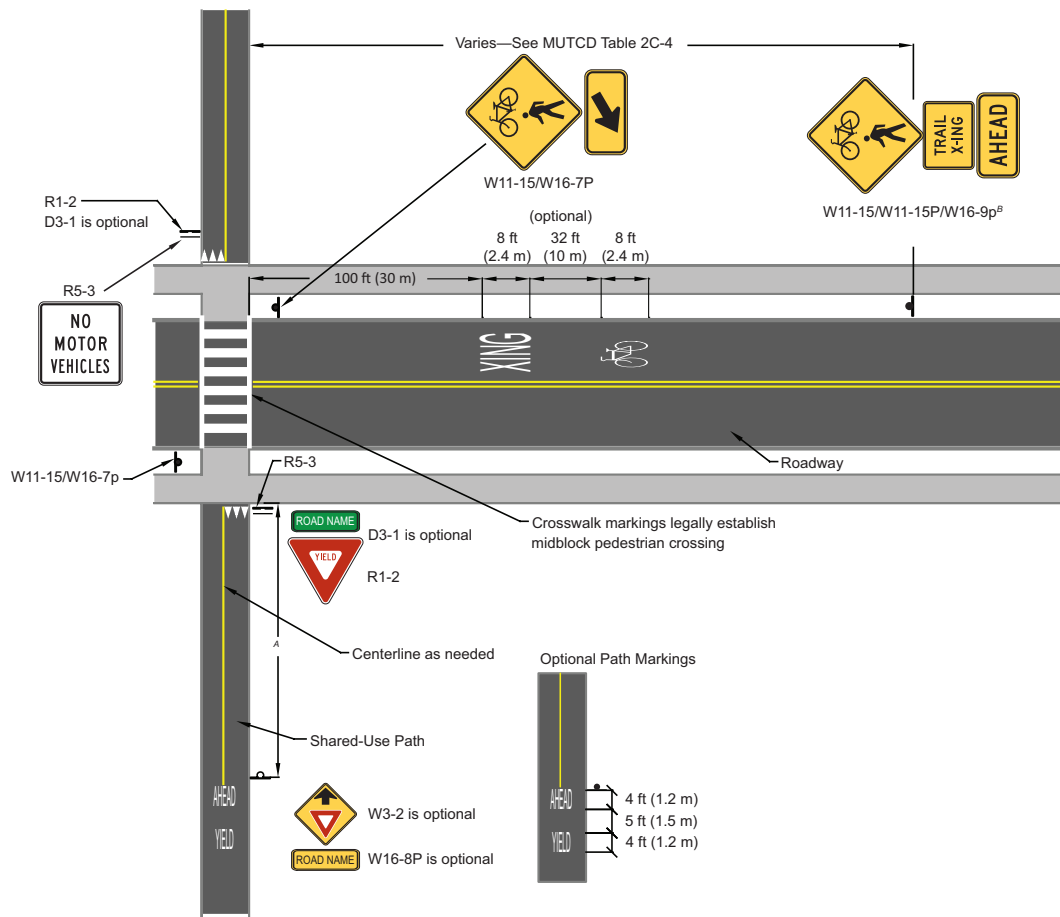

Notes:

- ^A Advance warning signs and solid centerline striping should be placed at the required stopping sight distance from the roadway edge, but not less than 50 ft (15 m).
- ^B W11 series sign is required, supplemental plaques are optional.

Figure 5-17. Example of Mid-Block Path—Roadway Intersection—Path Is Yield Controlled for Bicyclists

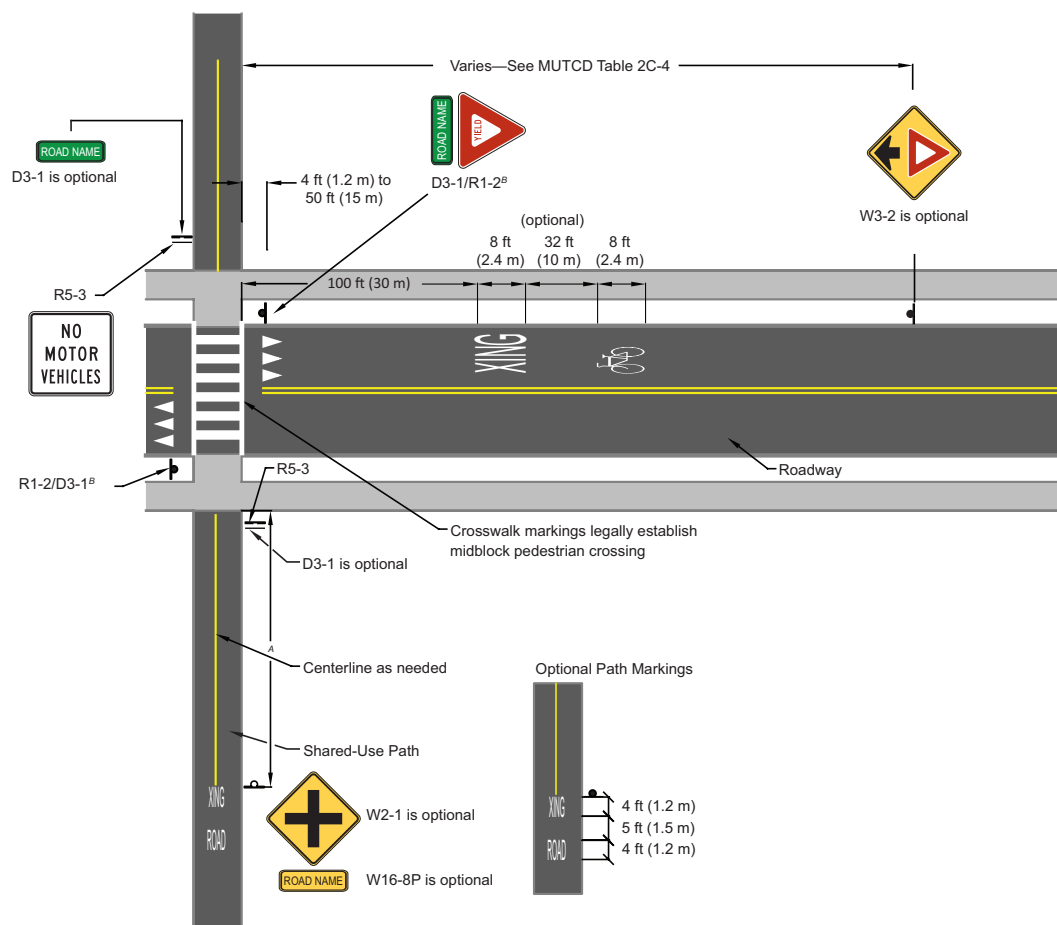

Notes:

- ^A Advance warning signs and solid centerline striping should be placed at the required stopping sight distance from the roadway edge, but not less than 50 ft (15 m).
- ^B D3-1 sign is optional, R1-2 sign is required. At multilane road crossings, the R1-5 series (Yield Here To/Stop Here for Pedestrians signs and markings, placed in advance of the crosswalk to reduce multiple-threat crashes) may be a more appropriate solution.

Figure 5-18. Example Mid-Block Path—Roadway Intersection—Roadway Is Yield Controlled

Chapter 5: Design of Shared Use Paths

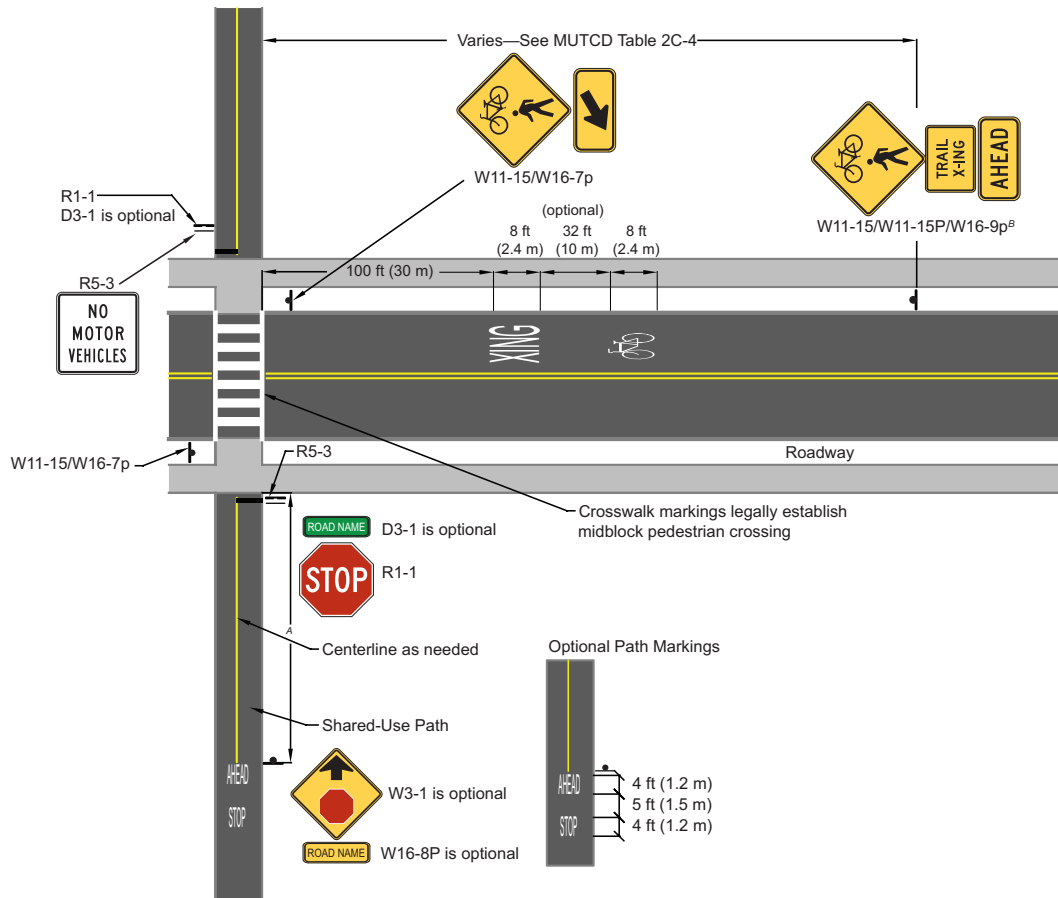

Notes:

- ^A Advance warning signs and solid centerline striping should be placed at the required stopping sight distance from the roadway edge, but not less than 50 ft (15 m).
- ^B W11 series sign is required, supplemental plaques are optional.

Figure 5-19. Example of Mid-Block Path—Roadway Intersection—Path is Stop Controlled for Bicyclists

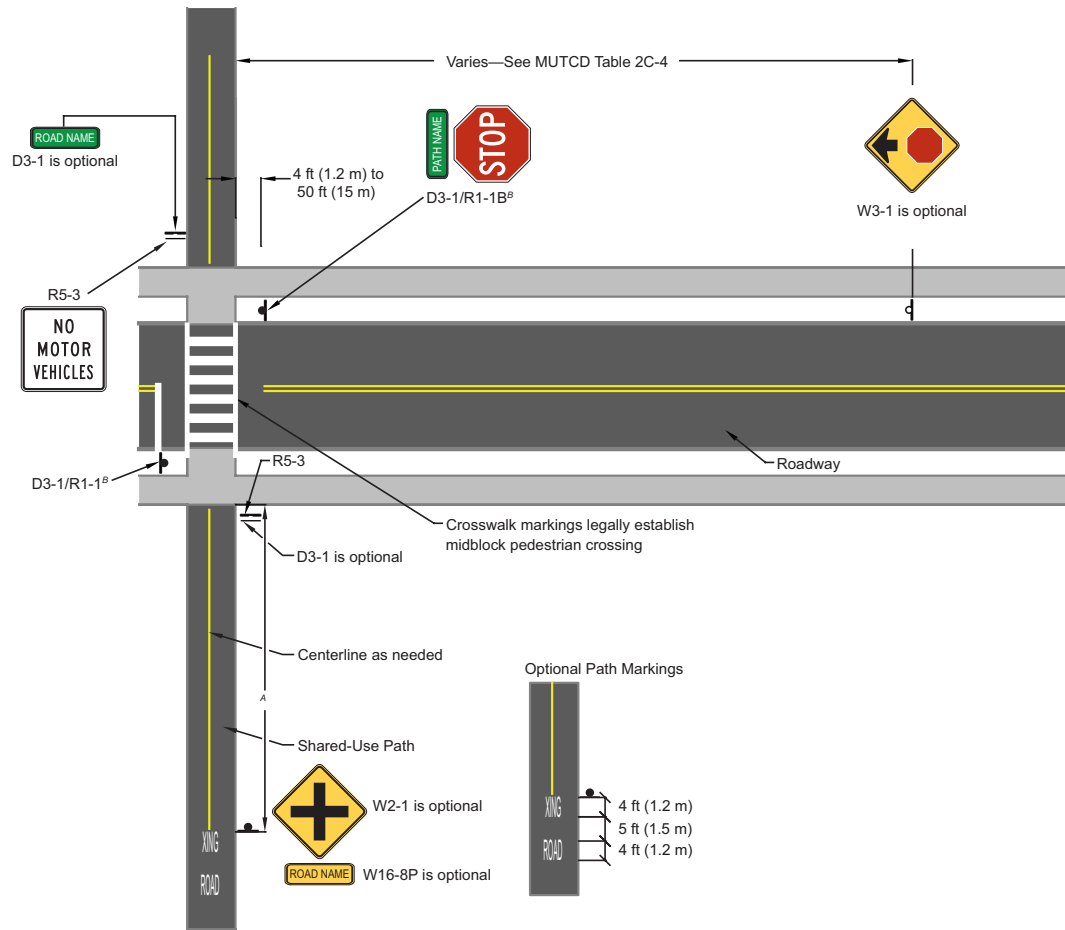

Notes:

- ^A Advance warning signs and solid centerline striping should be placed at the required stopping sight distance from the roadway edge, but not less than 50 ft (15 m).
- ^B D3-1 sign is optional, R1-2 sign is required. At multilane road crossings, the R1-5 series (Yield Here To/Stop Here for Pedestrians signs and markings, placed in advance of the crosswalk to reduce multiple-threat crashes) may be a more appropriate solution.

Figure 5-20. Example Mid-Block Path–Roadway Intersection—Roadway is Stop Controlled

5.3.4 Sidepath Intersection Design Considerations

This section presents several design measures that may be considered when designing sidepath intersections. Depending upon motor vehicle and pathway user speeds, the width and character of the adjacent roadway, the amount of separation between the pathway and the roadway, and the characteristics of conflict points, sidepath travel may involve lesser or greater likelihood of motor vehicle collisions for bicyclists than roadway travel. This section concludes with additional details on the operational challenges of sidepath intersections, building upon the challenges described in Section 5.2.2.

The first and most important step in the design of any sidepath is to objectively assess whether the location is a candidate for a two-way sidepath. Guidance on this issue is given in Section 5.2.2. At-grade intersections of roadways and driveways with sidepaths, especially those with two-way sidepaths, have inherent conflicts that may result in bicycle–motor vehicle crashes. When ap-

proaching an intersection, drivers focus their attention in certain specific directions, depending on the planned maneuver through the intersection. If planning to turn left from the parallel roadway, drivers focus their attention ahead to watch for a gap in oncoming traffic and to the left to watch for potentially conflicting traffic on the side road. When turning right from the parallel roadway, drivers focus their attention ahead and to the right, as this is the direction from which they expect conflicting traffic. When turning onto the parallel roadway (or crossing the parallel roadway) from a side road or a driveway, drivers almost exclusively focus on traffic approaching from the left, in order to look for a gap and to avoid conflicting traffic. Figure 5-4 illustrates the typical scanning behavior of drivers when turning or approaching an intersection or driveway near a sidepath.

Sidepaths, especially two-way sidepaths, insert path users into intersections at locations that do not match with the ingrained scanning behaviors of motorists, which can in effect create virtual “blind spots,” even in locations with no actual restrictions on sight distance or visibility. For example, a driver turning left from the parallel roadway across the sidepath might do a very conscientious job of looking for potentially conflicting traffic from the parallel road and crossroad, but completely miss a path user approaching from behind and to the driver’s left, a location from which a driver is not conditioned or trained to expect conflicting traffic. It is nearly impossible for a driver turning left from the parallel roadway across the sidepath to accurately monitor the presence, location, or speed of sidepath traffic approaching from behind and to the left without compromising the ability to look for potential conflicts from other directions. Similar mismatches between scanning behavior of roadway traffic and arrival locations of sidepath traffic can be found with right turns from the parallel roadway and movements from the crossing roadway. On multilane streets with higher speed limits, the situation can be more challenging, due to narrowing field of vision, shorter reaction times, and the screening effect of other traffic in adjacent lanes.

Sidepath users typically take their right of way cues from either the pedestrian signalization or the signals controlling the parallel roadway. Path users typically enter the intersection when the parallel roadway has a green indication. Some path users, mainly pedestrians, observe the pedestrian signal and enter under the walk phase, but bicyclists often continue to enter and cross the intersection well into the “DONT WALK” phase. Conflicts between roadway traffic and sidepath users can be complicated by the perception among some path users that turning and crossing drivers will yield to sidepath traffic when the path user has the right of way (e.g., when given a green signal or “WALK” signal) and the potentially conflicting vehicle is visible to the path user; however, due to scanning patterns, the vehicle driver may not look in the direction of the path user. Conventional signalization may not be effective in mitigating these conflicts.

Assuming that the location has been determined to be a candidate for a two-way sidepath, pathway width and separation from roadway at intersections and driveways should be determined with respect to roadway speeds and number of lanes. Motorists on multilane roadways with higher speeds are more distracted by driving conditions, and are less likely to notice the presence of bicyclists on the sidepath during turning movements. On roads with speed limits of 50 mph (80 km/h) or greater, increasing the separation from roadway is recommended to improve path user comfort and potentially reduce crashes. At lower speeds, greater separation does not reduce crashes; therefore the sidepath should be located in close proximity to the parallel roadway at intersections, so motorists turning off the roadway can better detect sidepath riders (11).

Three countermeasures that may reduce crash frequency and severity at driveways and intersections are: (1) reduce the speeds of both path users and motorists at conflict points; (2) increase

the predictability of sidepath and road user behavior; and (3) limit the amount of exposure at these conflict points as much as practical.

While the design measures described here are not necessarily supported by research that shows their implementation will reduce crashes, they are rational measures that may improve the quality of bicycle facilities. These design measures include the following:

- Reduce the density of driveways and the incidence of less predictable driveway movements through access management. For example, combine driveways of adjacent properties, reduce driveway width to the minimum needed to accommodate ingress and egress volumes, and prevent left turns into driveways by allowing only right-in, right-out movements. However, if the access management instead serves to concentrate the traffic at a single driveway or intersection, then the conflicts may be displaced from the old location to the new location.
- Design intersections to reduce driver speeds and heighten awareness of path users. Strategies include tighter corner radii, avoidance of high-speed, free-flowing movements (such as ramp-style turns), providing median refuge islands, maintaining adequate sight distances between intersecting users, and other measures to reduce motor vehicle speeds at intersections. The use of additional standard signs and markings, or the use of enhanced or unconventional signs and markings, may not have a notable effect on driver or path user behavior.
- Design driveways to reduce driver speeds and heighten awareness of path users. Strategies can include tighter corner radii; maintaining adequate sight distances; and keeping the path surface continuous across the driveway entrance, so that it is clear that motorists are crossing an area where the path user has the right of way, among other measures. The use of additional standard signs and markings, or the use of enhanced or unconventional signs and markings, may not have a notable effect on driver or path user behavior.
- Consider design measures on approaches to intersections and driveways that encourage lower speeds for pathway approaches. There are a variety of measures that jurisdictions have used to encourage lower speeds; however, it is important that these measures not limit visibility or create conflicts for pathway users, or cause the pathway to become inaccessible. This is another reason why in many cases it is important to accommodate bicycles on the roadway as well as the sidepath, so that bicyclists who prefer to travel at faster speeds may do so on the roadway.
- Employ measures on the parallel roadway (appropriate to the roadway function) to reduce speeds. These may include, among others, installation of raised medians, reduction of the number of travel lanes, and provision of on-street parking (configured so as to avoid restriction of sight lines at driveways).
- Design intersection crossings to facilitate bicycle access to and from the road or driveway that is being crossed, as this location represents an entry and exit point to the pathway.

- Keep approaches to intersections and major driveways clear of obstructions due to parked vehicles, shrubs, and signs on public or private property. Consider adding stop bars or yield markings for vehicles pulling up to the sidepath intersection.

At signalized intersections, the pathway should be integrated into the controls of the intersection following the same principles as a pedestrian crossing. Care should be taken to avoid turning movements that will conflict with the “green” signal for the pathway. Some design measures may include:

- Institute fully-protected left- and right-turn movements from the parallel street across the sidepath. This may help to mitigate some crash types; however, this may have significant effects on intersection operation and capacity, especially when implementing protected-only right-turns.
- Prohibit right turns on red from the crossing roadway. This may help to mitigate conflicts, but may need targeted enforcement to maintain effectiveness if drivers do not perceive a need for this restriction.
- Provide a leading pedestrian interval, and provide an exclusive pedestrian phase where there are high volumes of path users.

Pedestrian countdown signal heads and accessible push buttons should be provided along with high visibility crosswalks, crossing islands at wide intersections, and sufficient space for queuing bicyclists, if high volumes of pathway users are expected.

As described above, in locations where the sidepath parallels a high-speed roadway and crosses a minor road, it is advisable to move the crossing away from the intersection to a mid-block location. By moving the crossing away from the intersection, motorists are able to exit the high speed roadway first, and then turn their attention to the pathway crossing.

5.3.5 Other Intersection Treatments

Curb Ramps and Aprons

The opening of a shared use path at the roadway should be at least the same width as the shared use path itself. If a curb ramp is provided, the ramp should be the full width of the path, not including any side flares if utilized. The approach should provide a smooth and accessible transition between the path and the roadway. The ramp should be designed in accordance with the proposed PROWAG (13). Detectable warnings should be placed across the full width of the ramp. A 5-ft (1.5-m) radius or flare may be considered to facilitate turns for bicyclists. Unpaved shared use paths should be provided with paved aprons extending a minimum of 20 ft (6 m) from paved road surfaces.

Path Widening at Intersections

For locations where queuing at an intersection results in crowding at the roadway edge, consideration can be given to widening the path approach. This can increase the crossing capacity and help reduce conflicts at path entrances.

Shared Use Path Chicanes

Chicanes (i.e., horizontal curvature) can be designed to reduce path users' approach speeds at intersections where users must stop or yield, or where sight distance is limited. Care should be taken to end chicanes far enough in advance of the intersection to allow the user to focus on the curves in the pathway first, then the approaching intersection (rather than both at the same time). A solid centerline stripe is recommended at chicanes to reduce the instances of bicyclists "cutting the corners" of the curves. Chicanes should not be designed for speeds less than 8 mph (13 km/h).

Restricting Motor Vehicle Traffic

Unauthorized use of pathways by motor vehicles occurs occasionally. In general, this is a greater issue on pathways that extend through independent rights-of-way that are not visible from adjacent roads and properties. Per the MUTCD (7), the R5-3, "No Motor Vehicles" sign can be used to reinforce the rules.

The routine use of bollards and other similar barriers to restrict motor vehicle traffic is not recommended. Bollards should not be used unless there is a documented history of unauthorized intrusion by motor vehicles. Barriers such as bollards, fences, or other similar devices create permanent obstacles to path users. Bollards on pathways may be struck by bicyclists and other path users and can cause serious injury. Approaching riders may shield even a conspicuous bollard from a following rider's view until a point where the rider lacks sufficient time to react.

Furthermore, physical barriers are often ineffective at the job they were intended for—keeping out motorized traffic. People who are determined to use the path illegally will often find a way around the physical barrier, damaging path structures and adjacent vegetation. Barrier features can also slow access for emergency responders. A three-step approach may be used to prevent unauthorized motor vehicle entry to shared use paths:

1. Post signs identifying the entry as a shared use path and regulatory signs prohibiting motor vehicle entry. For example, the R5-3, "No Motor Vehicles" sign may be placed near where roads and shared use paths cross and at other path entry locations.
2. Design the path entry location so that it does not look like a vehicle access and make intentional access by unauthorized users difficult. A preferred method of restricting entry of motor vehicles is to split the entry way into two sections separated by low landscaping. Each section should be half the nominal path width; for example a 10-ft (3-m) path should be split into two 5-ft (1.5-m) sections. Emergency vehicles can still enter, if needed, by straddling the landscaping. Alternatively, it may be more appropriate to designate emergency vehicle access via protected access drives that can be secured. The approach to the split should be delineated with solid line pavement markings to guide the path user around the split.
3. Assess whether signing and path entry design prevents or reduces unauthorized traffic to tolerable levels. If motor vehicle incursion is isolated to a specific location, consider targeted surveillance and enforcement. If unauthorized use persists, assess whether the problems posed by unauthorized vehicle entry exceed the risks and access issues posed by barriers. Where the need for bollards or other vertical barriers in the pathway can be justified despite their risks and access issues, measures should be taken to make them as compatible as possible with the needs of bicyclists and other path users (6):

Chapter 5: Design of Shared Use Paths

- ▶ Bollards should be marked with a retroreflectorized material on both sides or with appropriate object markers, per Section 9B.26 of the MUTCD (7).
- ▶ Bollards should permit passage, without dismounting, for adult tricycles, bicycles towing trailers, and tandem bicycles. Bollards should not restrict access for people with disabilities. All users legally permitted to use the facility should be accommodated; failure to do so increases the likelihood that pathway users will collide with the bollards.
- ▶ Bollard placement should provide adequate sight distance to allow users to adjust their speed to avoid hitting them.
- ▶ Bollards should be a minimum height of 40 in. (1.0 m) and minimum diameter of 4 in. (100 mm). Some jurisdictions have used taller bollards that can be seen above users in order to reinforce their visibility.
- ▶ Striping an envelope around the approach to the post is recommended as shown in Figure 5-21 to guide path users around the object.
- ▶ One strategy is to use flexible delineators, which may reduce unauthorized vehicle access without causing the injuries that are common with rigid bollards.
- ▶ Bollards should only be installed in locations where vehicles cannot easily bypass the bollard. Use of one bollard in the center of the path is preferred. When more than one post is used, an odd number of posts spaced at 6 ft (1.8 m) is desirable. However, two posts are not recommended, as they direct opposing path users towards the middle, creating conflict and the possibility of a head-on collision. Wider spacing can allow entry to motor vehicles, while narrower spacing might prevent entry by adult tricycles, wheelchair users, and bicycles with trailers.
- ▶ Bollards should be set back from the roadway edge a minimum of 30 ft (10 m). Bollards set back from the intersection allow path users to navigate around the bollard before approaching the roadway.
- ▶ Hardware installed in the ground to hold a bollard or post should be flush with the surface to avoid creating an additional obstacle.
- ▶ Lockable, removable (or reclining) bollards allow entrance by authorized vehicles.

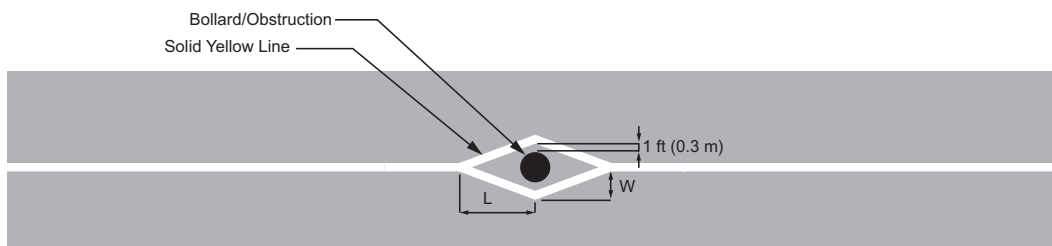

Figure 5-21. Bollard Approach Markings

Crossing Islands

Raised medians are associated with significantly lower pedestrian crash rates at multilane crossings. Although crossing islands (or medians) can be helpful on most road types, they are of particular benefit at path–roadway intersections in which one or more of the following apply: (1) high volumes of roadway traffic and/or speeds create difficult crossing conditions for path users; (2) roadway width is excessive given the available crossing time; or (3) the roadway cross section is three or more lanes in width. In addition to reducing the likelihood for bicycle crashes, crossing islands benefit children, the elderly, the disabled, and others who travel slowly.

Crossing islands should be large enough to accommodate platoons of users, including groups of pedestrians and/or bicyclists, tandem bicycles (which are considerably longer than standard bicycles), wheelchairs, people with baby strollers, and equestrians (if this is a permitted path use). The area may be designed with the storage aligned perpendicularly across the island or via a diagonal or offset storage bay (see example in Figure 5-22). The diagonal storage area has the added benefit of directing attention towards oncoming traffic, and should therefore be angled towards the direction from which traffic is approaching. Crossing islands should be designed in accordance with the proposed *Public Rights-of-Way Accessibility Guidelines* (PROWAG) (13). The minimum width of the storage area (shown as dimension “Y” in Figure 5-22) should be 6 ft (1.8 m); however, 10 ft (3 m) is preferred in order to accommodate a bicycle with a trailer.

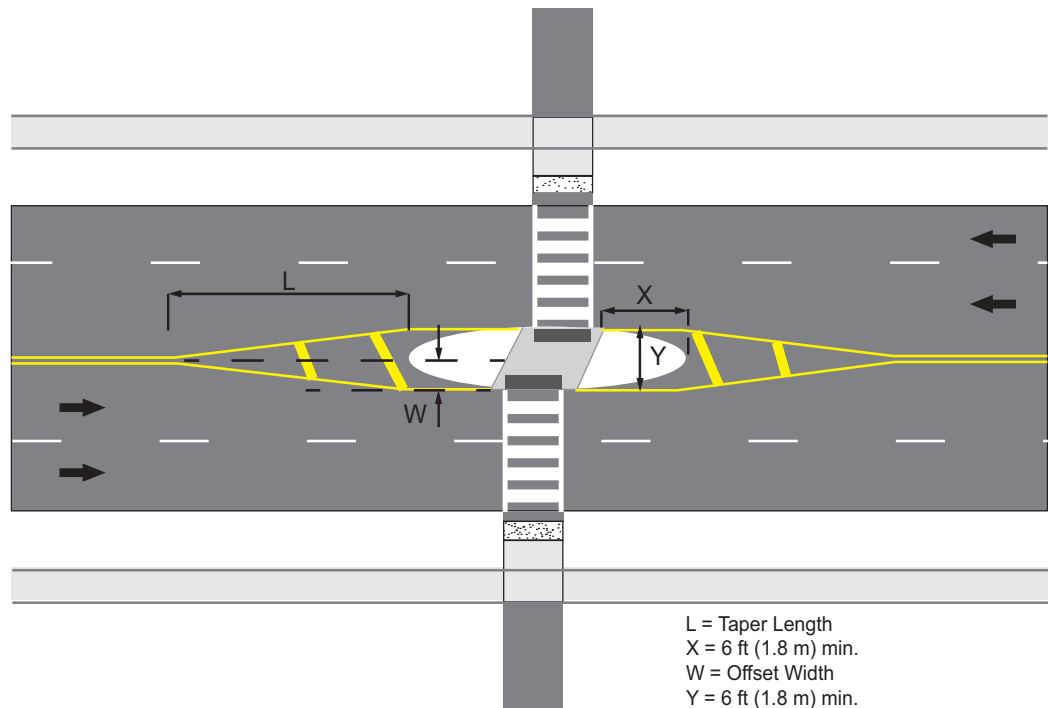

Figure 5-22. Crossing Island (see Table 5-9 to compute taper length)

Table 5-9. Taper Length

U.S. Customary			Metric		
$L = \frac{wV^2}{60}$, where $V < 45$ mph			$L = \frac{wV^2}{155}$, where $V < 70$ km/h		
$L = WV$, where $V \geq 45$ mph			$L = 0.62 WV$, where $V \geq 70$ km/h		
where:			where:		
L	=	taper length (ft)	L	=	taper length (m)
W	=	offset width (ft)	W	=	offset width (m)
V	=	approach speed (mph)	V	=	approach speed (km/h)

5.3.6 Additional Bicycle Crossing Considerations

Transition Zones

Where a shared use path crosses or terminates at an existing road, it is important to integrate the path into the existing system of on-road bicycle facilities to accommodate bicyclists and into sidewalks to accommodate pedestrians and other path users. Care should be taken to properly design the terminus to transition the traffic into an effective merging or diverging situation. Appropriate signing is needed to warn and direct both bicyclists and motorists at such transition areas. Each roadway crossing is also an access point, and should therefore be designed to facilitate movements of path users who either enter the path from the road, or plan to exit the path and use the roadway.

Traffic Calming for Intersections

At crossing locations where the speed of approaching roadway traffic is a concern, traffic calming measures may be helpful. These can include locations where roadway users are expected to yield to path users and sidepath crossings where road users turn across the path. Slower motorist approach speeds can improve the ability of path users to judge gaps, improve motorists' preparedness to yield to path users at the crossing, and reduce the severity of injuries in the event of a collision.

Traffic calming measures that may be appropriate include a raised intersection or raised crosswalk, chicanes, curb extensions, speed cushions, crossing islands, and curb radius reduction at corners. Traffic calming measures at path–roadway intersections should not be designed in a way that makes path access inconvenient or difficult for bicyclists on the roadway who may wish to enter the path, or vice versa.

Shared Use Paths Through Interchanges

Where a shared use path is parallel to a roadway that intersects with a freeway, separation and continuity of the path should be provided. Users should not need to exit the path, ride on roadways and/or sidewalks through the interchange, and then resume riding on a path.

At higher volume interchanges, a path may need grade-separated crossings to enable users to cross free-flow exit and entrance ramps with reasonable convenience and reduced likelihood for crashes. An engineering analysis should be done to determine if grade separation is needed. Away from ramps, paths can often be carried (with appropriate roadway separation or barrier) on the same structure that carries the parallel roadway through the interchange. See Section 5.2.10 for guidance on the design of structures.

5.4 PAVEMENT MARKINGS, SIGNS, AND SIGNALS

The MUTCD (7) regulates the design and use of all traffic control devices. Part 9 of the MUTCD presents standards and guidance for the design and use of signs, pavement markings, and signals that may be used to regulate, warn, and guide bicyclists on roadways and pathways. Other parts of the MUTCD also include information relevant to shared use path operation and should be consulted as needed. Path users should never be given conflicting traffic control messages (e.g., use of a “STOP” sign at a signalized intersection), leaving it unclear as to which device should be followed.

5.4.1 Pavement Markings

Pavement markings can provide important guidance and information for path and roadway users. Pavement markings should be retroreflective. They should not be slippery or rise more than 0.16 in. (4 mm) above the pavement.

Marked Crosswalks

Marked crosswalks are recommended at intersections between shared use paths and roadways. They delineate the crossing location and can help alert roadway users to the potential conflict ahead. At a mid-block location, no legally recognized crosswalk for pedestrians is present if no crosswalk is marked. As noted in Section 5.3.2 some states extend the rights and responsibilities of pedestrians at crosswalks to bicyclists, while other states do not; therefore, it is important for designers to understand the laws within their state regarding assignment of right of way for pedestrians and bicyclists (and other path users).

Where crosswalks are marked at shared use path crossings, the use of high visibility (i.e., ladder or zebra) markings is recommended as these are more visible to approaching roadway users. More information on the installation of crosswalks at path–roadway intersections is provided in Section 5.3.2.

Centerline Striping

A 4 to 6 in. (100 to 150 mm) wide, yellow centerline stripe may be used to separate opposite directions of travel where passing is inadvisable. This stripe should be dotted where there is adequate passing sight distance, and solid in locations where passing by path users should be discouraged. This may be particularly beneficial in the following circumstances: (1) for pathways with heavy user volumes; (2) on curves with restricted sight distance, or design speeds less than 14 mph (24 km/h); and (3) on unlit paths where night-time riding is not prohibited. The use of the broken centerline stripe may not be appropriate in parks or natural settings. However, on paths where a centerline is not provided along the entire length of the path, appropriate locations for a solid centerline stripe should still be considered where described above.

A solid yellow centerline stripe may be used on the approach to intersections to discourage passing on the approach and departure of an intersection. If used, the centerline should be striped solid up to the stopping sight distance from edge of sidewalk (or roadway, if no sidewalk is present). A consistent approach to intersection striping can help to increase awareness of intersections.

Edgeline Striping

Edgeline striping may be considered for use on shared use paths under several situations. The use of 4 to 6 in. (100 to 150 mm) wide, white edge lines may be beneficial on shared use paths where nighttime use is not prohibited. The use of white edge lines may be considered at approaches to intersections to alert path users of changing conditions, and if the pathway design includes a separate area for pedestrian travel, it should be separated from the bicycle traveled way by a normal white line. Refer to Section 5.2.1 for more information on segregation of traffic.

Approach Markings for Obstructions

Obstructions should not be located in the clear width of a path. Where an obstruction on the traveled portion occurs (for example, in situations where bollards are used), channelizing lines of appropriate color (yellow for centerline, otherwise white) should be used to guide path users around it. An example of a centerline treatment is given in Figure 5-21. For obstructions located on the edge of the path, an obstruction marking (see Figure 4-30) should be used. Approach markings should be tapered from the approach end of the obstruction to a point at least 1 ft (0.3 m) from the obstruction (See Table 4-1 to determine taper length).

Pavement Markings to Supplement Intersection Control

Stop and yield lines may be used to indicate the point at which a path user should stop or yield at a traffic control device. Design of stop and yield lines is described in Chapter 3B of the MUTCD (7). Stop or yield lines may be placed across the entire width of the path. If used, the stop or yield line should be placed a minimum of 2 ft (0.6 m) behind the nearest sidewalk or edge of roadway if a sidewalk is not present.

Supplemental Pavement Markings on Approaches

Advance pavement markings may be used on roadway or path approaches at crossings where the crossing is unexpected or where there is a history of crashes, conflicts, or complaints. If a supplemental word marking (such as “HWY XING”) is used, its leading edge should be located at or near the point where the approaching user passes the intersection warning sign or advance traffic control warning sign that the marking supplements. Additional markings may be placed closer to the crossing if needed, but should be at least 50 ft (15 m) from the crossing. Advance pavement markings may be placed across the entire width of the path or within the approach lane. Pavement markings should not replace the appropriate signs. Pavement markings may be words or symbols as described in Part 3 of the MUTCD (7).

Advance Stop or Yield Lines

Advance stop lines or yield lines may be used on multilane roadway approaches to a path crossing where the path is given priority. The applicability of either a stop line or a yield line is governed by state law. Figure 5-23 shows an application of advanced yield lines, and Figures 5-18 and 5-20 illustrate the use of both applications where the path is given priority. Advance stop and yield lines reduce the likelihood for a multiple-threat crash between the path user and a vehicle. The advance stop or yield line provides a clearer field of vision between path users who are crossing the road and approaching vehicles in both lanes. These treatments have shown promising results (16), (17).

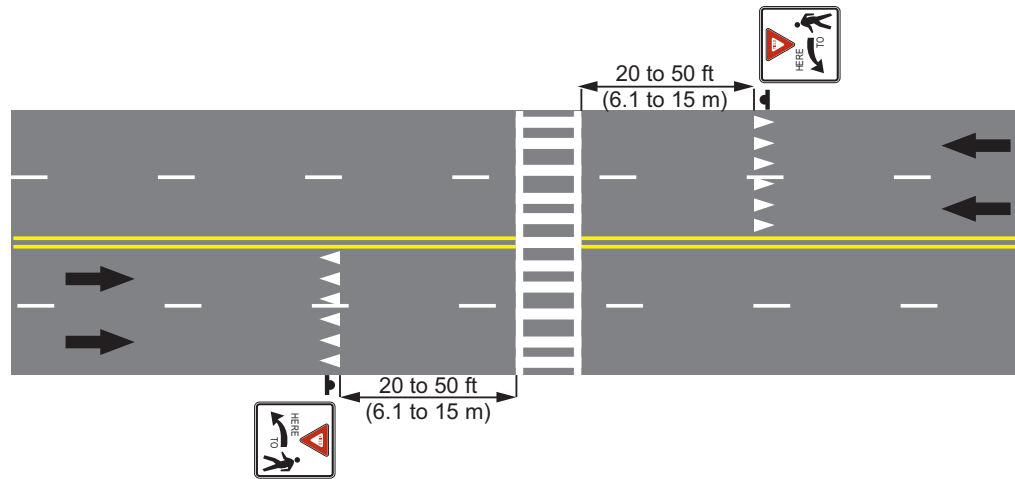

Figure 5-23. Advance Yield Signs and Markings

5.4.2 Signs

All signs should be retroreflective and conform to the color, legend, and shape requirements described in the MUTCD. (7) Signs used along a path may be reduced in size per Table 9B-1 of the MUTCD. Signs utilized along a roadway which are visible to motorists should not be reduced in size and should conform to the sizes established in the MUTCD.

Regulatory signs notify pathway (and roadway) users of location-specific regulations. Such a sign is installed at or near the location where the regulation applies. Regulatory signs are generally rectangular with white backgrounds and black text and symbols.

Warning signs are utilized to notify road and pathway users of unexpected conditions that might need a reduction of speed or other action. A warning sign should be used, for example, where pathway width is reduced in a short section because of a constraint. However, warning signs should be used sparingly; use perceived as excessive or unnecessary can result in disrespect for other important signs.

Warning signs are diamond shaped with black symbols and text. Permanent warning signs for bicycle facilities should be yellow or fluorescent yellow-green (temporary warning signs should be orange). In general, a uniform application of warning signs of the same color should be used.

For advance warning sign placements on shared use paths, the sign should be placed to allow adequate perception-response time. The location of the sign should be based on the stopping sight distance needed by the fastest expected path user; however, in no instance should the sign be located closer than 100 ft (30 m) from the location warranting the advance warning. Warning signs should not be placed too far in advance of the condition, such that path users tend to forget the warning because of other distractions.

The purpose of guide and wayfinding signs is to inform path users of intersecting routes, direct them to important destinations, and generally to give information that will help them along their way in the most simple and direct manner. Guide signs are rectangular with green backgrounds and white text.

Shared Use Path Crossing Warning Sign Assembly

Roadway users may be warned of a shared use path crossing by utilizing a combined bicycle-pedestrian warning sign (W11-15), as shown in Figure 5-24, or a bicycle warning sign (W11-1). On a roadway approach to a path crossing, placement of an intersection or advance traffic control warning sign should be at (or close to) the distance recommended for the approach speed in Table 2C-4 of the MUTCD (7). See Figures 5-17 through 5-20.

The assembly consists of a W11-15 or a W11-1 accompanied by a W16-7p (downward arrow) plaque mounted below the warning sign. This sign should not be installed at the crossing if the roadway traffic is yield-, stop-, or signal-controlled. The W16-8P (path name) plaque may be mounted on the sign assembly (below the W11-15 or W11-1 sign) to notify approaching roadway users of the name of the shared use path being crossed.

At path crossings that experience frequent conflicts between motorists and path users, or on multilane roadways where a sign on the right-hand side of the roadway may not be visible to all travel lanes, an additional path crossing warning sign assembly should be installed on the opposite side of the road, or on the refuge island, if there is one.

The combined bicycle-pedestrian warning sign (W11-15) or bicycle warning sign (W11-1) may be used in advance of shared use path crossings of roadways. Again, this warning sign should not be used in advance of locations where the roadway is stop-, yield-, or signal-controlled. Advance warning sign assemblies may be supplemented with a W16-9p (AHEAD) plaque or W16-2P (XX FEET) plaque located below the W11-15P sign.

Traffic Control Regulatory Signs

“YIELD” and “STOP” signs are used to assign priority at controlled but unsignalized path–roadway intersections. The choice of traffic control (if any) should be made with reference to the priority assignment guidance provided in Section 5.3.2 and in the MUTCD. The design and use of the signs is described in sections 2B and 9B of the MUTCD (7).

Intersection and Advance Traffic Control Warning Signs

Advance traffic control warning signs announce the presence of a traffic control of the indicated type (“YIELD,” “STOP,” or signal) where the control itself is not visible for a sufficient distance on an approach for users to respond to the device. An intersection warning sign may be used in advance of an intersection to indicate the presence of the intersection and the possibility of turning or entering traffic.

On a shared use path approach, placement of an advance warning sign should be at a distance at least as great as the stopping sight distance of the fastest expected path user in advance of the location to which the sign applies. In no case should the advance placement distance be less than 50 ft (15 m). See Figures 5-17 through 5-20.

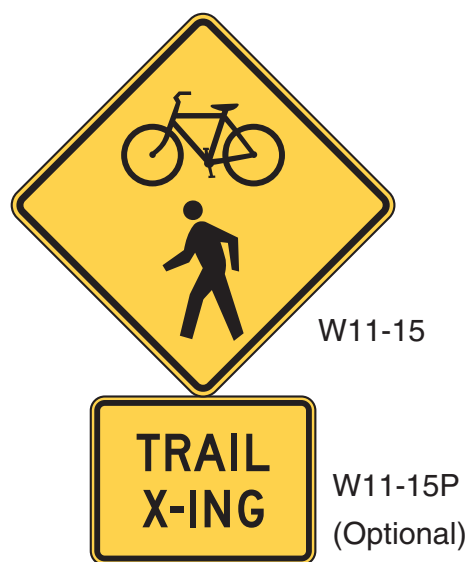

Figure 5-24. Advance Warning Assembly Example

An intersection or advance traffic control warning sign may carry a W16-8P (road or path name) plaque to identify the intersecting road or path, as appropriate for the approach. An advisory speed (W13-1) plaque may be added to the bottom of the sign assembly to advise the approaching user to the proper traveling speed for the available sight lines or geometric conditions.

Guide Signs

Road name/path name signs (D3-1 and W16-8P) should be placed at all path–roadway crossings. This helps path users track their locations. At mid-block crossings, the D3-1 sign may be installed on the same post with a regulatory sign.

Guide signs to indicate directions, destinations, distances, route numbers, and names of crossing streets should be used in the same manner as on roadways and as described in Section 4.11.

Reference location signs (also called mile markers) assist path users in estimating their progress, provide a means for identifying the location of emergency incidents, and are beneficial during maintenance activities. Section 9B.24 of the MUTCD provides guidance for the use of reference location signs.

Where used, wayfinding signs for shared use paths should be implemented according to the principles discussed in Section 4.11. Mode-specific guide signs (D11-1a, D11-2, D11-3, and D11-4) may be used to guide different types of users to the traveled way that is intended for their respective modes (see Figure 5-25). If used, the signs should be installed at the point where the separate pathways diverge (see Section 9B.25 of the MUTCD) (7).



Figure 5-25. Mode-Specific Guide Signs

5.4.3 Signalized and Active Warning Crossings

As discussed earlier in this chapter, it may be appropriate to provide active warning or a traffic signal at some shared use path crossings of roadways. Guidance on the need for a signal and other traffic control devices is provided in the MUTCD (7) and in other sources such as FHWA’s *Safety Effects of Marked Versus Unmarked Crosswalks at Uncontrolled Locations: Final Report and Recommended Guidelines* (18). Path user volumes may be used to determine the need for a signal and/or other active warning devices, and in some situations when considering path user volume, it may be appropriate to assess whether the path users have access to another appropriate crossing location.

Signalized shared use path crossings should be operated so the slowest user type likely to use the path will be accommodated. This will typically be the pedestrian. For manually operated signal actuation, the push button should be located in a position that is accessible from the path and in

accordance with the proposed PROWAG (13). Bicyclists should not have to dismount to activate the signal. Part 9 of the MUTCD provides a variety of signs that are appropriate for these locations.

Another method of signal actuation is to provide automated detection (such as an inductive loop in the pavement); however, if the detection device is such that it does not detect pedestrians and other path users, it should be supplemented with a pushbutton. At signalized intersections on divided roadways, a push button should also be located in the median for those path users who may be trapped in the refuge area. Further discussion of signal design considerations is in Chapter 4. Path crossing warning sign assemblies (W11-15) should not be used at a signal-controlled shared use path–roadway intersection.

In locations where motor vehicle traffic delay is a concern, a pedestrian hybrid beacon (popularly known as a HAWK (High-intensity Activated Cross Walk) may be considered, in accordance with MUTCD (7). This signal is activated with a pushbutton. It controls traffic on the roadway by using a combination of red and yellow signal lenses, while the path approach is controlled by pedestrian signals.

A warning beacon is another type of crossing device that can be considered. A flashing warning beacon is a signal that displays flashing yellow indications to an approach. It is typically a single light, but can be installed in other combinations. A common application is to add a flashing amber signal to the top of a standard warning sign to bring attention to a shared use path crossing. The flashing signal may also be used on overhead signs at crosswalks. Flashing beacons are more effective if they only flash when path users are present, rather than flashing continuously—and therefore should be actuated by path users. However, flashing beacons have shown little or no effectiveness in many crosswalk or crossing situations.

REFERENCES

1. AASHTO. *AASHTO LRFD Bridge Design Specifications*, Sixth Edition. American Association of State Highway and Transportation Officials, Washington, DC, 2012.
2. AASHTO. *Guide for the Planning, Design, and Operation of Pedestrian Facilities*. American Association of State Highway and Transportation Officials, Washington, DC, 2004.
3. AASHTO. *LRFD Guide Specifications for Design of Pedestrian Bridges*, Second Edition. American Association of State Highway and Transportation Officials, Washington, DC, 2009.
4. AASHTO. *Roadway Lighting Design Guide*. American Association of State Highway and Transportation Officials, Washington, DC, 2005.
5. AASHTO. *A Policy on Geometric Design of Highways and Streets*. American Association of State Highway and Transportation Officials, Washington, DC, 2011.
6. FHWA. *DRAFT: Accessibility Guidance for Bicycle and Pedestrian Facilities, Recreational Trails, and Transportation Enhancement Activities*. Federal Highway Administration, U.S. Department of Transportation, Washington, DC, October 2008.
http://www.fhwa.dot.gov/environment/recreational_trails/guidance/accessibility_guidance/guidance_accessibility.cfm

7. FHWA. *Manual on Uniform Traffic Control Devices*. Federal Highway Administration, U.S. Department of Transportation, Washington, DC, 2009.
8. FHWA. *Shared Use path Level of Service—A User's Guide*. FHWA-HRT-05-138. Federal Highway Administration, U.S. Department of Transportation, Washington, DC, 2006.
9. FHWA. *Shared Use Path Level of Service Calculator*. FHWA-HRT-05-138. Federal Highway Administration, U.S. Department of Transportation, Washington, DC, 2006.
<http://www.fhwa.dot.gov/publications/research/safety/pedbike/05138/index.cfm>
10. Landis, B. W., T. A. Petrisch, and H. F. Huang. *Characteristics of Emerging Road and Trail Users and Their Safety*. Federal Highway Administration, McLean, VA, 2004.
11. Petrisch, T. A., B. W. Landis, H. F. Huang, and S. Challa. *Sidepath Safety Model—Bicycle Sidepath Design Factors Affecting Crash Rates*. In *Transportation Research Record*, Vol. 1982. Washington, DC, 2006.
12. United States Access Board. *Architectural Barriers Act Accessibility Guidelines for Shared Use Paths*. 36 CFR Chapter XI, published on March 28, 2011. United States Access Board, Washington, DC, 2011.
13. United States Access Board. *Proposed Accessibility Guidelines for Pedestrian Facilities in the Public Right-of-Way*. 36 CFR, Part 1190, published July 26, 2011. United States Access Board, Washington, DC, 2011.
14. United States Access Board. *Shared Use Path Accessibility Guidelines*. United States Access Board, Washington, DC, 2011.
15. USDA. *Equestrian Design Guidebook for Trails, Trailheads, and Campgrounds*. Forest Service, U.S. Department of Agriculture, Washington, DC, 2007.
16. Van Houten, R. The Effects of Advance Stop Lines and Sign Prompts on Pedestrian Safety in Crosswalk on a Multilane Highway. *Journal of Applied Behavior Analysis*, Vol. 21, Lawrence, KS, 1988.
17. Van Houten, R., J.E.L. Malenfant, and D. McCusker. *Advance Yield Marking, Reducing Motor Vehicle-Pedestrian Conflicts at Multilane Crosswalks with Uncontrolled Approach*. In *Transportation Research Record*, Vol. 1773/2001, Washington, DC, 2001.
18. Zegeer, C. V., J. R. Stewart, H. H. Huang, P. A. Lagerwey, J. Feaganes and B. J. Campbell. *Safety Effects of Marked Versus Unmarked Crosswalks at Uncontrolled Locations: Final Report and Recommended Guidelines*. s.l. FHWA-HRT-04-100. Federal Highway Administration, Washington, DC, 2005.



Photo courtesy of Patricia Little.

Bicycle Parking Facilities

6.1 INTRODUCTION

Providing bicycle parking facilities is an essential element in a multi-modal transportation system. Unlike motor vehicles, most bicycles are not equipped with locks or anti-theft devices and do not require a key to operate. In addition, while they can be temporarily immobilized by locking a wheel to the frame, this does not prevent theft due to the bicycle's relatively light weight and small size.

In addition to helping prevent theft, installing well-designed bicycle parking facilities in appropriate locations can contribute to a more orderly and aesthetic appearance of sidewalks and building sites. In the absence of bicycle parking or where parking facilities are inconveniently located, people may lock their bicycles to any stationary object such as a sign post, parking meter, fence, or tree. These randomly located bicycles may interfere with pedestrian movements or vehicular traffic flow, and make a sidewalk inaccessible to persons with disabilities. Providing bike parking can also be an inexpensive strategy to increase overall parking supply.

This chapter outlines recommendations for the planning and design of bicycle parking facilities that meet the needs of different types of bicycles and bicycle trips. Bicycle parking facilities should be provided at both the trip origin and trip destination. The wide variety of bicycle parking devices available is generally grouped into two classes, long-term and short-term. The needs for each differ in terms of their design and level of protection. In many locations, a combination of short- and long-term options may be appropriate.

6.2 PLANNING FOR BICYCLE PARKING

Bike parking facilities can be planned for and installed in a number of ways. Bicycle parking should be provided at all public facilities, should be incorporated into roadway and streetscape projects, and should be an integral aspect of land development and redevelopment processes. Many communities provide bicycle parking in the public right-of-way in response to requests from business owners or



D4-3

Figure 6-1. Directional Signage for Bicycle Storage

property managers. Consulting with local bicyclists can be an excellent way to determine where bicycle parking is needed.

Requiring bicycle parking in new development and redevelopment is a cost effective way to provide bicycle parking. Many communities have sought to increase the availability of bicycle parking through the local zoning and permitting process. One approach is to establish bicycle parking requirements relative to expected demand based on land use. Another approach is to require that bicycle parking spaces be provided in proportion (often 1:10) to the total number of automobile parking spaces. However, this approach can be problematic where there is a simultaneous effort to reduce motor vehicle parking and increase pedestrian and bicycle mode shares. The need for bicycle parking may increase over time, so plans should anticipate this need for increased capacity.

Bicyclists will seek to park as close as practical to their final destination. Bicycle parking should, therefore, be conveniently placed in a location that is highly visible and as close to the building entrance as practical. In the event that directional signage is needed to indicate the

location of bicycle parking, the MUTCD provides a sign that can be used for this purpose (see Figure 6-1) (2).

The location of bicycle racks should follow these guidelines:

- Easily accessible from the street and protected from motor vehicles.
- Visible to passers-by to promote usage and enhance security.
- Does not impede or interfere with pedestrian traffic or routine maintenance activities.
- Does not block access to buildings, bus boarding, or freight loading.
- Allows reasonable clearance for opening of passenger-side doors of parked cars.
- Are covered, if practical, where users will leave their bikes for a longer amount of time (see Section 6.4).

Bicycle parking requirements should be sufficiently detailed to address the design elements discussed in this chapter.

6.3 SHORT-TERM BICYCLE PARKING FACILITIES

Short-term parking facilities should be installed wherever people will need to leave their bicycles unattended for a short period of time. In general, bicycle parking should be considered wherever motor vehicle parking is provided and in areas where motor vehicle parking is not provided at individual properties, such as downtown areas or other high-density locations.

Bicycle parking should be easy to locate and simple to use. Priority locations include stores; restaurants; apartment and condominium complexes; offices and public facilities such as transit stops, schools, parks, and libraries. Two key components of successful short-term parking are location and facility design.

6.3.1 Site Design

When designing bicycle parking sites, it is important to consider the amount of space used by a fully occupied rack and the space needed for bicyclists to access the parking area and use both sides of the rack. Below is a list of recommended dimensions for bicycle parking sites. Measurements should be made from an object to the nearest vertical component of rack.

Distance to other racks:

- Rack units aligned end-to-end should be placed a minimum of 96 in. (2.4 m) apart.
- Rack units aligned side-by-side should be placed a minimum of 36 in. (0.9 m) apart.

Distance from a curb:

- Racks located perpendicular to a curb should be a minimum of 36 in. (0.9 m) from the back of curb.
- Racks located parallel to a curb should be a minimum of 24 in. (0.6 m) from the back of curb.

Distance from a wall:

- Assuming access is needed from both sides, U-racks located perpendicular to a wall should be a minimum of 48 in. (1.2 m) from the wall.
- Racks located parallel to a wall should be a minimum of 36 in. (0.9 m) from the wall.

Well-designed bicycle parking needs only minimal maintenance. Damaged racks should be fixed, or removed and replaced. Periodic removal of abandoned bikes and locks, especially at transit stations and universities, may be needed. Abandoned bikes or bike wheels locked to racks reduce capacity and may discourage others from bicycling due to perceived risk of theft. Education may help reduce incorrect locking techniques and instruction for proper use may be placed on or near the rack (1).

6.3.2 Rack Design

One of the simplest, most effective types of short-term bicycle parking is the “inverted U” bike rack (see Figure 6-2). This rack supports the parking of two bikes simultaneously, one on each side of the rack, and can be grouped to provide additional spaces as needed. Some racks accommodate more than two bikes, although these facilities should be designed based on the principles listed below, so that capacity is not limited by incorrect use.



Figure 6-2. Example of “Inverted U” Bicycle Rack (Photo courtesy of Peter Lagerwey of Toole Design Group.)

Racks should be constructed out of strong metal tubing and securely anchored to the ground unless the rack is of sufficient size and weight to prevent easy removal. If the rack is secured to a durable base, vandal- and theft-resistant hardware should be used. A crossbar (as shown in Figure 6-2) is recommended to prevent a bike from being stolen by knocking over the U-rack and slipping the lock over the end of the newly exposed post.

In all cases the parking area beneath the rack should be a concrete or asphalt surface and large enough to support bicycles locked to the rack. The design of bicycle racks should follow these guidelines:

- Support the bicycle at two points above its center of gravity.
- Accommodate high security U-shaped bike locks.
- Accommodate locks securing the frame and one or both wheels (preferably without removing the front wheel from the bicycle.)
- Provide adequate distance (minimum 36 in. [0.9 m]) between spaces so that bicycles do not interfere with each other.
- Do not contain protruding elements or sharp edges.
- Do not bend wheels or damage other bicycle parts.
- Do not make the user lift the bicycle off the ground (*I*).

6.3.3 Considerations for Special Types of Racks

Art Racks

Artistically-inspired bicycle parking facilities can add a desirable element to a streetscape. If poorly designed, however, the facility may not provide the same degree of security or ease of use as other simpler designs and can contain protruding elements that could be struck by pedestrians and other bicyclists. If used, artistically-inspired racks should be designed in accordance with all of the design and location guidelines described above.

Wave Racks

Wave racks or ribbon racks are not recommended. While they offer some perceived economic and aesthetic benefits, they are commonly used incorrectly and when used as intended do not provide adequate support or spacing.

Schoolyard Racks

Also referred to as “dish-rack” or “comb” style, these racks are not recommended, and those still in use should be replaced. These racks are poorly designed as they support the bike only by the front wheel, which can bend the rim, and they do not support proper locking and thus provide inadequate theft prevention to the user.

6.4 LONG-TERM BICYCLE PARKING FACILITIES

Long-term bicycle parking facilities should provide a high degree of security and protection from the weather. They are intended for situations where the bicycle is left unattended for long periods of time, such as apartments and condominium complexes, schools, places of employment, and

transit stops. The simplest type of long-term parking is a structure that covers a bicycle parking area and offers sufficient protection from the elements. Long-term bicycle parking facilities can also include lockers, monitored bike parking areas, or a dedicated space or room within a building or a parking garage. Long-term parking facilities should be well lit and accessible to provide a high degree of personal security. Signs may be needed to direct bicyclists to long term parking.

Bicycle lockers are self-contained units that can store an individual bicycle and related accessories and provide a high level of security. They should be constructed from a strong, weather resistant, and maintenance-free material. Most bicycle locker systems involve user registration and public agency administration and maintenance. The effective capacity of lockers may be somewhat limited as parking is only available to the registered individual. Some transit agencies are exploring the use of smart cards to reduce management costs and increase security and availability. Homeland security concerns should also be taken in to account, and lockers may be required to include a transparent element to detect inappropriate use. The siting of lockers in public spaces should also be carefully considered to minimize negative impacts.

Another strategy for long-term parking is to create an access-controlled space that contains racks for support and locking of individual bikes. If located outdoors, the space should be covered and well lit. Creating an indoor bike room is an option for residential and employment centers. Bike rooms should be easy to access and, if not located on the ground floor, should be accessible by elevator. Rooms and cages should include racks that are designed and sited according to the recommendations for short-term parking.

The use of two-tiered racks can provide increased parking capacity in areas with limited space availability. Consider providing a mechanism to assist the user in lifting their bicycle onto the second tier. It is important that people be able to securely lock their bicycles, as theft can be a problem in shared spaces. Rooms should be designed so that, when racks are occupied, sufficient space is available in between racks to access parked bicycles. If no space is available, buildings may still provide a long-term parking option by permitting employees to bring their bicycles into their personal work space. Some transit agencies provide staffed bicycle parking areas which offer valet parking to customers. Some communities have created dedicated bicycle parking structures offering a range of amenities including showers and lockers, and bicycle repair service. These can provide excellent support for bicycling within a community and have been very successful in areas with high levels of bicycle use (1).

REFERENCES

1. Association of Pedestrian and Bicycle Professionals. *Bicycle Parking Guidelines*. Washington, DC, 2002.
2. FHWA. *Manual on Uniform Traffic Control Devices*. Federal Highway Administration, U.S. Department of Transportation, Washington, DC, 2009.



Maintenance and Operations

7.1 INTRODUCTION

Bikeways are subject to surface deterioration and debris accumulation, and need maintenance to function well. Poorly maintained facilities may become unusable for bicyclists.

What may be an adequate roadway surface for automobiles can cause difficulties for bicyclists who ride on narrow, high-pressure tires. Uneven longitudinal cracks and joints can divert a bicycle wheel. Gravel blown off the travel lane by traffic often accumulates in the area where bicyclists ride. Small rocks, branches, and other debris can deflect a wheel, and potholes can cause wheel rims to bend, leading to spills. An accumulation of leaves can hide a pothole. Broken glass can puncture bicycle tires. A good maintenance program protects public funds invested in bikeways, so they can continue to be used effectively.

7.2 RECOMMENDED MAINTENANCE PROGRAMS AND ACTIVITIES

A bikeway maintenance program is needed so that facilities are adequately maintained. Sufficient funds should be budgeted to accomplish the needed tasks. Neighboring jurisdictions can consider joint programs for greater efficiency and reduced cost. The program should establish maintenance standards and a schedule for inspections and maintenance activities as recommended in Section 7.2.1. A maintenance program should consider policies and practices that are good for the environment (e.g., minimizing impervious surfaces and using recyclable materials). It may be desirable for maintenance personnel to coordinate with designers to develop more sustainable bikeway infrastructure.

Road users are usually the first to experience deficiencies. Spot-improvement programs enable bicyclists to bring concerns to the attention of authorities in a quick and efficient manner. An online complaint/comment submission form facilitates public input about bikeway maintenance concerns. Many jurisdictions have maintenance reporting systems that can be expanded to include requests

from bicyclists. Quick response from the responsible agency improves communication between the public and staff.

As agencies develop their maintenance programs, it is logical to first focus their efforts on bikeways. As maintenance programs mature and become more established, programs should be expanded to include other bicycle facilities even if they are not specifically defined for bicycle use.

7.2.1 Sweeping

Bicyclists often avoid shoulders and bike lanes filled with gravel, broken glass, and other debris. Regularly scheduled maintenance should involve regular sweeping of litter on the traveled way. Debris from the roadway should not be swept onto sidewalks; nor should debris from sidewalks be swept onto the roadway.

Shared use paths can also accumulate debris that can cause difficulties for bicyclists. This is especially true for paths that are located in coastal areas, paths that extend through wooded areas, and paths along waterways that overflow during storm events.

Some jurisdictions use sand or gravel to treat roadways during snow events or icy conditions. These treatments may degrade conditions for bicycling, in addition to clogging storm drains and raising other long-term infrastructure maintenance issues. Jurisdictions that use sand or gravel should sweep bikeways periodically, particularly after major storm events.

The following recommendations can help to alleviate concerns for bicyclists caused by debris:

- Establish a regular sweeping schedule for roadways and pathways that anticipates both routine and special sweeping needs. This may involve more frequent sweeping seasonally, and also should include periodic inspection, particularly in areas that experience frequent flooding, or in areas that have frequent vandalism. The sweeping program should be designed to respond to user requests for sweeping activities.
- Remove debris in curbed sections with maintenance vehicles that pick up the debris; on roads with flush shoulders, debris can be swept off the pavement.
- Reduce the presence of loose gravel on roadway shoulders by paving gravel driveway approaches. Also require parties responsible for debris to contain it; for example, require tarps on trucks loaded with gravel. Local ordinances often require tow-vehicle operators to remove glass after crashes, and contractors are usually required to clean up daily after construction operations that leave gravel and dirt on the roadway.

7.2.2 Surface Repairs

Cracks, potholes, bumps, and other surface defects can degrade bicycling conditions. The following recommendations apply:

- Inspect bikeways regularly for surface irregularities; after noticing or receiving notice of a surface irregularity, repairs should be made promptly.
- Establish a process that enables the responsible agency to respond to user complaints in a timely manner.

- Prevent the edge of a surface repair from running longitudinally through a bike lane or shoulder.
- Perform preventative maintenance periodically, such as keeping drains in operating condition and eliminating intrusive tree roots.
- Sweep a project area after repairs.
- Develop a pavement preservation program for bikeways to minimize deterioration and cracking.
- Reduce long-term maintenance needs by building bikeways, especially paths, to a high pavement standard so they last a long time without needing significant maintenance or expensive repair. This could include selecting a pavement material that is resistant to root damage, or selectively placing root barriers in locations where root damage is expected to be a concern.

7.2.3 Pavement Overlays

Pavement overlays are good opportunities to improve conditions for bicyclists, if done carefully; a ridge should not be left in the area where bicyclists ride or are anticipated to ride (this occurs when an overlay extends part-way into a shoulder bikeway or bike lane). Overlay projects offer opportunities to widen the roadway, or to restripe the roadway with bike lanes (see Chapter 4).

The following recommendations can help to make pavement overlays compatible with bicycle travel:

- Extend the overlay over the entire roadway surface, including shoulder bikeways and bike lanes, to avoid leaving an abrupt edge within the riding area. If the surface conditions are acceptable on the shoulder or bike lane, the pavement overlay can stop at the shoulder or bike lane stripe, provided no abrupt ridge remains at the stripe.
- Correct any pavement edge drop-offs that may develop.
- During overlay projects, maintain the surface of inlet grates and utility covers to within 0.25 in. (6 mm) of the pavement surface (or raise to this level, where needed), and replace any that are not bicycle-friendly with those that are (see Section 4.12.8).
- Pave at least 10 ft (3 m) back on (low-volume) driveway connections, and 30 ft (9 m) or to the right-of-way line, whichever is less, on unpaved public road connections, to prevent gravel from spilling onto shoulders or bike lanes.
- Sweep the project area after overlay to prevent loose gravel from adhering to the freshly paved shoulder or bike lane.

7.2.4 Vegetation

Vegetation encroaching into bikeways can impede bicyclists. Roots should be controlled to prevent surface breakup as they can undermine a path surface and make the path hazardous or

even impassable for all users. Adequate clearances and sight distances should be maintained at driveways and intersections. Bicyclists should be visible to approaching motorists, not hidden by overgrown shrubs or low-hanging branches, which can also obscure signs. The following recommendations apply to vegetation control and removal:

- Cut back vegetation to prevent encroachment.
- Cut back intrusive tree roots and install root barriers where appropriate.
- Adopt local ordinances to require adjacent landowners to control vegetation and/or allow road authorities to control vegetation that originates from private property.

7.2.5 Traffic Signal Detectors

Repairs and modifications to traffic signals offer opportunities to improve their functionality for bicyclists. At traffic signals with detectors, check that a typical bicycle can trigger a response when no other vehicles are waiting at the signal. The following recommendations can help to make traffic signals more bicycle compatible:

- Adjust detector sensitivity so the signal can be actuated by a typical bicycle.
- Place a stencil over the most sensitive part of the detector to notify bicyclists where to wait to trigger a green signal (*I*).
- Adjust the signal phases to account for the speed of a typical bicyclist. See Chapter 4 for additional guidance on other detection technologies and evaluation and improvement of signal timing for bicycles.

7.2.6 Signs and Markings

New bikeway signs and markings are highly visible, but over time signs may fall into disrepair and markings may become hard to see, especially at night. Signs and markings should be kept in a readable condition, including those directed at motorists. The following recommendations apply to signs and markings:

- Inspect signs and markings regularly, including retroreflectivity at night.
- Replace defective or damaged signs as soon as possible.
- Replace symbol markings as needed; in high-use areas, symbol markings may need replacement more than once a year.

7.2.7 Drainage Improvements

Drainage facilities often deteriorate over time. Catch basins may need to be adjusted in height or replaced to improve drainage. A bicycle-compatible drainage grate flush with the pavement reduces jarring bumps that can cause loss of control. Curbs used to divert storm water into catch basins should have bicycle-compatible designs. The following recommendations apply to drainage improvements for bicycles:

- Reset catch basin grates flush with pavement.
- Modify or replace deficient drainage grates with bicycle-compatible grates. A policy for replacing inappropriate drainage grates during resurfacing and reconstruction is one way to accomplish this task over time.
- Repair or relocate faulty drainage at intersections where water backs up in the gutter.
- Adjust or relocate existing drainage curbs that encroach into shoulders or bike lanes.

7.2.8 Chip Sealing

Chip seals leave a rough surface for bicycling and are strongly discouraged. Chip seals that cover the traveled way and part of the shoulder area leave a ragged edge or ridge in the shoulder, degrading conditions for bicyclists. The following recommendations apply:

- Where a chip seal is used on a roadway shared with bicyclists, a fine mix chip seal [3/8 in. (10 mm) or finer] should be used.
- Where shoulders or bike lanes are wide enough and in good repair, apply the chip seal only to the main traveled way.

If the shoulders or bike lanes are chip sealed, the shoulder area should be covered with a well rolled, fine-textured material: 3/8 in. (10 mm) or finer for single pass, 1/4 in. (6 mm) for second pass.

- Sweep the shoulder area following chip seal operations.
- Chip seal should not be used on shared use paths.

7.2.9 Patching Activities

Road graders can provide a smooth pavement patch; however, the last pass of the grader sometimes leaves a rough tire track in the middle of the shoulder or area where bicyclists ride. Loose asphalt may at times collect on the shoulder, adhering to the freshly paved surface. The following recommendations apply:

- Equip road graders with smooth tires where practicable.
- Do not place the patch part way into the shoulder: stop the patch at the edge of the roadway, or cover the entire shoulder width.
- Roll the shoulder area after the last pass of the grader.
- Sweep loose materials off the roadway before they adhere to the fresh pavement.

7.2.10 Utility Cuts

Utility cuts can leave a rough surface for bicyclists if not back-filled carefully and fully compacted. Utility cuts should be finished as smooth as new pavement. The following recommendations apply:

- Wherever practical, place cut line in an area that will not interfere with bicycle travel, and make cuts parallel to bicycle traffic so that they do not leave a ridge or groove in the bicycle wheel track area.
- Back fill cuts in bikeways flush with the surface (humps will not get packed down by bicycle traffic).
- Compact the overlay properly to reduce or eliminate later settlement.

7.2.11 Snow Clearance

Many bicyclists ride year-round, especially for utilitarian or commute trips. Snow stored in bike lanes impedes bicycling in winter. The following recommendations apply:

- On streets with bike lanes and paved shoulders that are used by bicyclists, remove snow from all travel lanes (including bike lanes) and the shoulder, where practical.
- Do not store snow on sidewalks where it will impede pedestrian traffic.
- Snow may be stored on sidewalk street furniture zones or landscape strips where there is sufficient width.
- Remove snow from shared use paths that are regularly used by commuters, unless there is a desire to use the facility for cross-country skiing.

7.3 OPERATING BIKEWAYS IN WORK ZONES

Transportation construction projects often disrupt the public's mobility and access. Proper planning for bicyclists through and along work zones is as important as planning for motor vehicle traffic, especially in urban and suburban areas. The MUTCD states that the "needs and control of all road users (motorists, bicyclists, and pedestrians) through a temporary traffic control zone shall be an essential part of highway construction, utility work, maintenance operations, and the management of traffic incidents (1)." On roads where bicycling is not prohibited, work zone treatments such as temporary lane restrictions, detours, and other traffic control measures should be designed to accommodate bicyclists. The following recommendations should be incorporated into project construction plans:

- Plans for the maintenance of bicycle travel should be initiated whenever the need for temporary traffic controls is being considered. At the onset of planning for temporary traffic controls, it should be determined how existing bicycle facilities will be maintained during construction. Options include accommodating bicycles through the work zone or providing a detour route.
- Similar to other vehicular traffic, work zones should be compatible with bicycle travel. Work-zone concerns for bicyclists may include road or path closures, sudden changes in elevation, construction equipment or materials, and other unexpected conditions. Accommodation in the work zone may result in the need for the construction of temporary facilities including paved surfaces, structures, signs, and signals. The MUTCD includes appropriate mode-specific detour

guidelines in the section on temporary traffic controls (I). Where guidelines do not adequately cover a situation specific to bicycle use, general vehicular guidelines should be applied.

Workers who routinely perform maintenance and construction operations should be aware of these considerations.

7.3.1 Rural Highway Construction

Construction operations on rural highways can affect long-distance commuter, touring, and recreational bicyclists. On low-volume roads, or through short work zones, standard traffic control practices are usually adequate. Bicyclists are provided with access as long as a smooth, paved surface is maintained, and temporary signs, debris, and other obstructions are removed from the edge of the roadway after each day's work.

On high-volume roads or through long work zones, adequate paved roadway width should be provided, where practical, for motor vehicles to pass bicyclists. Flaggers and pilot cars should take into account the bicyclists' lower speeds when bicycles are present. Radio messages can be relayed to other flaggers if bicyclists are coming through as part of a platoon of vehicles. On highways with very high traffic volumes and speeds, and where construction will restrict available width for a long time, a detour route may be provided for bicyclists, where practical. The detour should not be overly circuitous, and M4-9 detour signs can be used to guide bicyclists along the route and back to the highway (I).

7.3.2 Urban Roadway Construction

In urban areas, effective and convenient passage is needed during construction for bicyclists. If a detour involves significant out-of-direction travel, the bicyclist will prefer to ride through the work zone. It is preferable to create a passage that allows bicyclists to proceed as close to their normal route as practical. Accommodation within the work zone is preferred. Closing a bikeway or installing signs asking bicyclists to take a detour is usually ineffective, as bicyclists can share a lane over a short distance. Detour routes that result in bicyclists making two left turns across heavy traffic are also discouraged and addressing such situations may involve providing two detours, one for each direction of travel.

On longer projects, and on busy roadways, a temporary bike lane or wide outside lane may be provided. Bicyclists should not be routed onto sidewalks or onto unpaved shoulders. Debris should be swept to maintain a reasonably smooth and clean riding surface in the outer few feet of roadway. Advance work zone signs should not obstruct the bicyclist's path. Signs should be placed in a buffer/planter strip, rather than in a bike lane or on a sidewalk. Where this is not practical, either raising the sign, or placing signs half on the sidewalk and half on the roadway may be the best solution. Bike lanes and sidewalks should not be used for storage of work zone signs or materials when work is halted for the day.

REFERENCES

1. FHWA. *Manual on Uniform Traffic Control Devices*. Federal Highway Administration, U.S. Department of Transportation, Washington, DC, 2009.

Index

Active warning crossings, 5-54

Advance stop, 5-51, 5-56

Aesthetics, 2-14

A Policy on Geometric Design of Highways and Streets, 1-4, 4-7, 4-23, 4-28, 4-30, 4-66, 5-34, 5-36, 5-55

Approach markings, 5-47, 5-51

Bicycle

boulevards, 2-5, 2-12, 2-19, 2-20, 3-11, 4-33, 4-34, 4-54, 5-2

crashes, 2-4, 2-8, 2-9, 2-11, 2-12, 2-14, 2-17, 2-23, 2-24, 2-25, 3-1, 3-6, 3-8, 3-9, 3-10, 3-11, 4-9, 4-12, 4-16, 4-28, 4-30, 4-31, 4-36, 4-54, 4-56, 4-57, 4-62, 4-63, 5-8, 5-9, 5-13, 5-15, 5-23, 5-27, 5-30, 5-33, 5-34, 5-42, 5-43, 5-44, 5-48, 5-49, 5-51, 7-2

route, 1-3, 2-20, 4-5, 4-23, 4-26

Bicycle Detector Pavement Marking, 4-49

Bicycle Lane, 1-2, 4-11, 4-14, 4-17, 4-18, 4-21, 4-60, 4-62

lines, 4-17

markings, 4-17

signs, 4-21

widths, 4-14

Bicycle Level of Service (BLOS), 1-3, 2-22, 2-29

Bicycle Master Plans, 2-6

Bicycle Travel Demand Analysis, 2-25

Bicyclist Crash Studies, 3-8

Bridges, 2-8, 2-15, 4-28, 4-41, 4-42, 4-43, 5-6, 5-27, 5-28

Child trailer, 3-3, 3-4

Chip sealing, 7-5

Construction, 1-1, 1-2, 2-8, 2-11, 2-12, 2-26, 4-28, 4-51, 5-16, 5-25, 5-28, 7-2, 7-6, 7-7

Corridor-level planning, 2-6, 2-12

Cost-benefit analysis, 2-14, 2-21

Crossing

angle, 4-38, 5-32

island, 5-33

surfaces, 4-38

Cross Slope, 5-15

Data collection, 2-9, 2-21, 2-24, 2-25

Design

speed, 2-17, 2-18, 4-64, 4-65, 5-3, 5-12, 5-13, 5-14, 5-15, 5-27, 5-35, 5-36

vehicle, 3-1, 4-51, 5-36

Diverters, 2-19, 4-33, 4-54

Drainage

grates, 4-2, 4-3, 4-29, 4-55, 5-26, 5-28, 7-5

improvements, 7-4

Elements of Design, 5-2

Flow analysis, 2-21

GIS-based data, 2-21

- Grade**, 2-11, 2-23, 4-12, 4-38, 4-42, 4-52, 4-57, 4-60, 4-62, 4-63, 5-12, 5-16, 5-17, 5-20, 5-27, 5-28, 5-30, 5-31, 5-42, 5-49
- Guide signs**, 4-36, 5-52, 5-54
- Horizontal alignment**, 5-13, 5-16
- Infrastructure**, 1-2, 2-6, 2-8, 2-9, 2-11, 2-15, 2-25, 7-1, 7-2
- Inline skaters**, 3-3, 3-9, 5-3, 5-20, 5-25
- Interchanges**, 2-8, 4-57, 4-60, 4-62, 4-63, 5-49
- Intersection design**, 4-22, 5-11, 5-30, 5-33
- Intersections**, 2-2, 2-5, 2-8, 2-13, 2-16, 2-18, 2-19, 2-20, 2-22, 2-23, 2-24, 2-28, 3-1, 3-6, 3-8, 3-9, 3-10, 3-11, 4-4, 4-7, 4-8, 4-13, 4-17, 4-18, 4-20, 4-22, 4-23, 4-26, 4-30, 4-32, 4-33, 4-35, 4-37, 4-43, 4-51, 4-52, 4-53, 4-54, 4-57, 4-59, 4-60, 4-63, 5-8, 5-9, 5-10, 5-11, 5-29, 5-30, 5-32, 5-33, 5-34, 5-38, 5-42, 5-43, 5-44, 5-45, 5-46, 5-48, 5-49, 5-50, 5-51, 5-53, 5-55, 7-4, 7-5
 - acute-angle, 4-23
- Lateral clearance**, 5-22
- Lean angle**, 5-13, 5-14, 5-16
- Left turn**, 3-5, 3-6, 4-5, 4-26, 4-31, 4-57, 5-9
- Lighting**, 3-4, 3-8, 3-9, 3-11, 4-22, 4-43, 4-50, 4-63, 5-29, 5-30
- Lockers**, 6-5
- Long-term bicycle parking facilities**, 6-4, 6-5
- Maintenance programs**, 7-1
- Manual on Uniform Traffic Control Devices (MUTCD)**, 1-2, 1-4, 2-20, 2-28, 4-4, 4-5, 4-17, 4-18, 4-20, 4-21, 4-34, 4-35, 4-36, 4-40, 4-47, 4-66, 5-3, 5-5, 5-15, 5-16, 5-17, 5-23, 5-33, 5-38, 5-46, 5-47, 5-50, 5-51, 5-52, 5-53, 5-54, 5-55, 5-56, 6-2, 6-5, 7-6, 7-7
- Mid-block crossings**, 5-32, 5-34, 5-54
- Mid-block intersection controls**, 5-38
- Network planning**, 2-6, 2-21
- Obstruction markings**, 4-40, 4-41
- One-way streets**, 2-27, 4-12, 4-25, 4-32
- On-road facilities**, 4-1
- On-street parking**, 2-17, 2-23, 3-5, 3-8, 4-2, 4-3, 4-12, 4-14, 4-15, 4-16, 4-18, 4-21, 4-29, 4-30, 4-32, 4-33, 4-52, 5-44
- Parallel parking**, 4-4, 4-5, 4-16, 4-17, 4-33
- Patching activities**, 7-5
- Paved shoulders**, 2-2, 2-5, 2-7, 2-8, 2-12, 2-19, 2-20, 3-11, 4-3, 4-4, 4-5, 4-7, 4-8, 4-28, 4-29, 4-30, 4-41, 4-42, 4-57, 5-2, 5-8, 7-6
- Pavement**
 - markings, 1-2, 2-7, 2-27, 4-11, 4-17, 4-22, 4-28, 4-34, 5-23, 5-25, 5-46, 5-50, 5-51
 - overlays, 7-3
- Project Level Planning**, 2-12
- Public Rights-of-Way Accessibility Guidelines (PROWAG)**, 5-2, 5-48
- Quality of Service (or Level of Service) Tools**, 2-22
- Rack Design**, 6-3
- Radius of curvature**, 5-13, 5-14, 5-15, 5-22
- Railroad Grade Crossings**, 4-38
- Recreational trips**, 2-3
- Recumbent bicycle**, 3-3
- Retrofitting**, 2-7, 2-27, 4-7, 4-11, 4-28
- Right of way**, 4-43, 5-32, 5-33, 5-43, 5-44, 5-50
- Right turn**, 4-23, 4-24, 4-57

Road diet, 4-30

Roadway widening, 2-11, 4-28

Roundabouts, 3-9, 4-26, 4-33, 4-52, 4-57,
4-63, 4-64, 4-65

Rumble strips, 1-3, 4-9, 4-10, 4-56, 5-11

Rural Highway Construction, 7-7

Safety analysis, 2-21

Shared lane, 1-4, 2-8, 2-16, 3-10, 3-11, 4-3,
4-4, 4-43

Shared-lane markings, 3-10, 4-3, 4-4, 4-5,
4-12, 4-13, 4-25, 4-43, 4-64

Shared roadway, 2-22, 4-34

Shared use path, 1-3, 1-4, 2-2, 2-16, 2-22,
3-1, 4-3, 4-4, 4-36, 4-38, 4-41, 4-42,
4-56, 4-65, 5-3, 5-4, 5-6, 5-8, 5-11,
5-12, 5-16, 5-26, 5-27, 5-28, 5-29,
5-30, 5-31, 5-37, 5-45, 5-46, 5-49,
5-50, 5-53, 5-54, 5-55

crossing type

grade-separated, 5-30

mid-block, 5-30

sidepath, 5-30

Short-term bicycle parking facilities, 6-2

Shoulder, 1-4, 2-9, 2-10, 2-13, 2-17, 2-18,
2-24, 4-7, 4-8, 4-9, 4-10, 4-11, 4-21,
4-28, 4-29, 4-38, 4-42, 4-56, 4-57,
4-60, 5-5, 5-11, 7-3, 7-5, 7-6

Shoulder bypass lanes, 4-8

Sidepath, 1-4, 5-30, 5-31, 5-32, 5-42, 5-43,
5-56

Signs, 1-2, 1-3, 2-13, 2-19, 2-20, 2-21, 2-27,
3-10, 3-11, 4-3, 4-4, 4-11, 4-14, 4-17,
4-21, 4-22, 4-34, 4-35, 4-36, 4-37,
4-53, 4-54, 5-3, 5-5, 5-9, 5-13, 5-15,
5-23, 5-34, 5-38, 5-44, 5-45, 5-46,
5-50, 5-51, 5-52, 5-53, 5-54, 5-55,
7-4, 7-6, 7-7

Signs and markings, 5-52, 7-4

Site design, 6-3

Snow clearance, 7-6

Speeds, 1-3, 2-3, 2-5, 2-9, 2-13, 2-16, 2-18,
2-19, 2-23, 2-24, 3-1, 3-4, 3-9, 3-10,
3-11, 4-2, 4-4, 4-7, 4-8, 4-9, 4-11,
4-12, 4-14, 4-15, 4-17, 4-23, 4-24,
4-26, 4-28, 4-30, 4-31, 4-32, 4-33,
4-36, 4-40, 4-42, 4-43, 4-45, 4-46,
4-51, 4-52, 4-53, 4-54, 4-57, 4-60,
4-62, 4-63, 4-65, 5-2, 5-8, 5-12, 5-13,
5-14, 5-15, 5-16, 5-17, 5-20, 5-30,
5-33, 5-34, 5-36, 5-42, 5-43, 5-44,
5-46, 5-48, 5-49, 5-50, 7-7

Stopping sight distance, 4-1, 4-2, 5-16,
5-17, 5-20, 5-22, 5-23, 5-34, 5-35,
5-37, 5-50, 5-52, 5-53

Striping

centerline, 5-50

edgeline, 5-51

Superelevation, 5-13, 5-14, 5-15, 5-16

Surface repairs, 7-2

Surface structure, 5-25

Sweeping, 7-2

Tandem bicycle, 3-3

Technical analysis tools, 2-21

Topography, 2-4, 2-26, 5-27

Traffic

calming, 3-10, 4-33, 4-51, 4-52, 4-53, 4-63

management, 4-53

principles, 3-1, 3-5

signal, 2-8, 4-34, 4-43, 4-46, 4-50, 4-57,
4-59, 5-9, 5-54

signal detectors, 7-4

volumes, 2-5, 2-9, 2-13, 2-18, 2-20, 2-23,
3-6, 3-11, 4-2, 4-7, 4-30, 4-32, 4-33,
4-56, 4-57, 4-63, 5-33, 5-38, 7-7

Transit, 2-1, 2-2, 2-4, 2-6, 2-7, 2-8, 2-9,
2-10, 2-11, 2-13, 2-15, 2-25, 2-26,
2-27, 2-28, 4-5, 5-29, 6-2, 6-3, 6-5

Transportation Impact/Traffic Studies, 2-6,
2-11

Transportation networks, 2-12

Traveled way, 1-3, 1-4, 4-3, 4-4, 4-5, 4-9,
4-16, 4-20, 4-52, 4-55, 5-11, 5-51,
5-54, 7-2, 7-5

Tunnels, 4-41, 4-42

Two-way streets, 4-12

Underpasses, 5-26

Unpaved paths, 5-12, 5-15, 5-25

Urban roadway construction, 7-7

Utilitarian trips, 2-2, 2-3, 2-26

Utility

covers, 4-11, 4-56, 5-26

cuts, 7-5

Vegetation, 7-3

Vertical curve, 4-7, 5-20, 5-21, 5-22

Viaducts, 4-41

Warning sign assembly, 5-53

Wayfinding, 2-8, 2-20, 2-21, 2-27, 4-34,
4-36, 5-52, 5-54

Width and clearance, 5-3

Work zones, 7-6

Yield lines, 5-51

American Association of State Highway and Transportation Officials
444 North Capitol Street, NW, Suite 249
Washington, DC, 20001

transportation.org



AMERICAN ASSOCIATION OF
STATE HIGHWAY AND
TRANSPORTATION OFFICIALS
AASHTO
THE VOICE OF TRANSPORTATION

Publication Code: GBF-4
ISBN: 978-1-56051-527-2