

PART PLAN

(a) These lines represent the toe of the slope if fill is not rolled up and over the culvert.

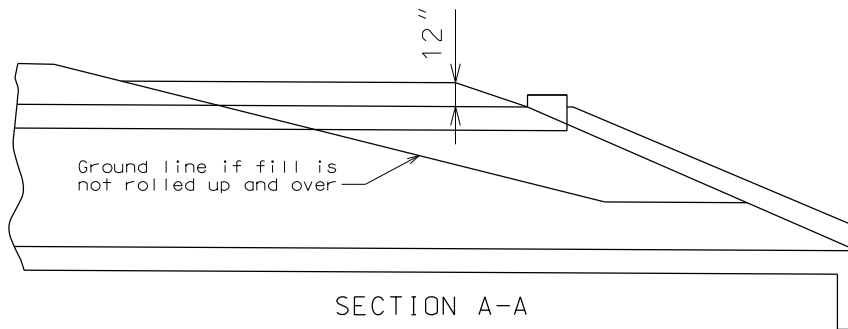

SECTION A-A

CASE 1

SHALLOW FILL AND HEADWALL  
PLACED OUTSIDE OF CLEAR ZONE

ROADWAY FILL "ROLLED UP AND OVER" EXPOSED CULVERT

Not to be shown on plans - For illustration purposes only

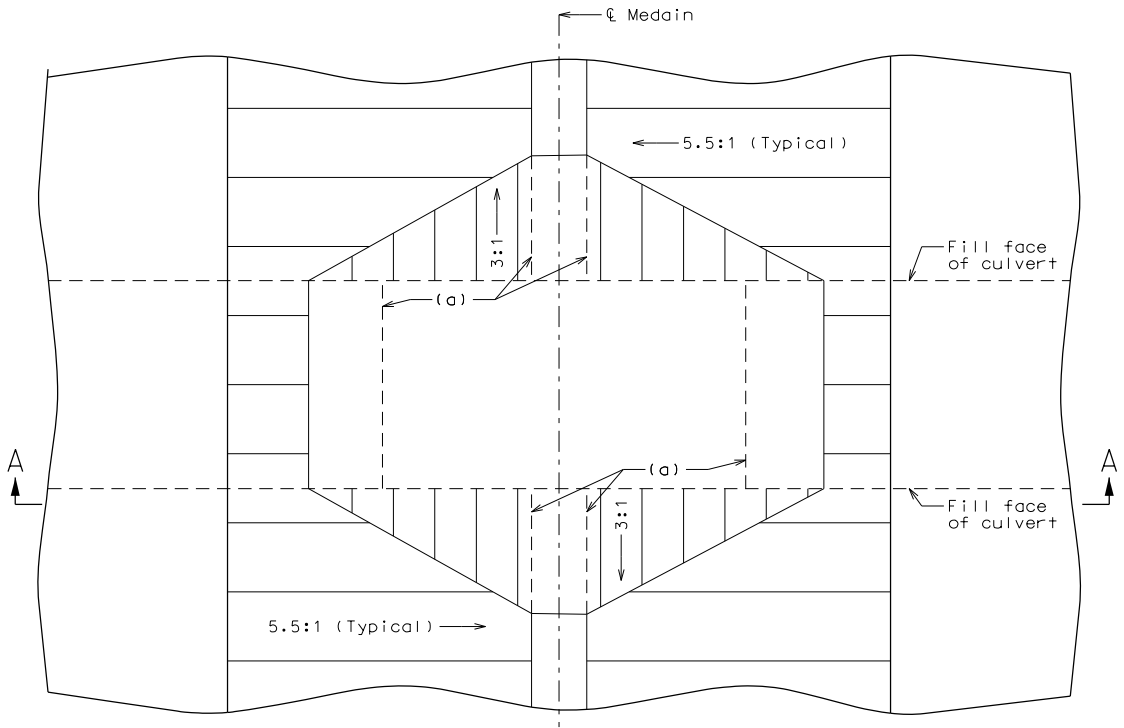

PART PLAN

(a) These lines represent the toe of the slope if fill is not rolled up and over the culvert.

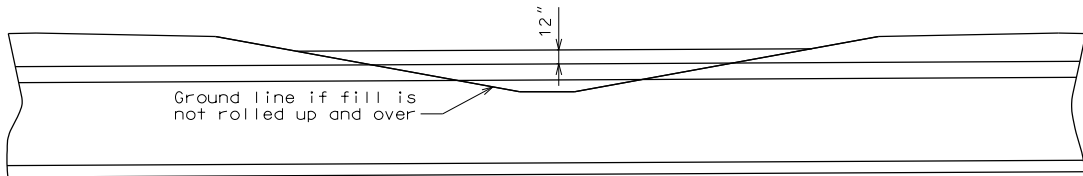

SECTION A-A

CASE 2

SHALLOW FILL IN MEDIAN OF A DIVIDED HIGHWAY

ROADWAY FILL "ROLLED UP AND OVER" EXPOSED CULVERT

Not to be shown on plans - For illustration purposes only

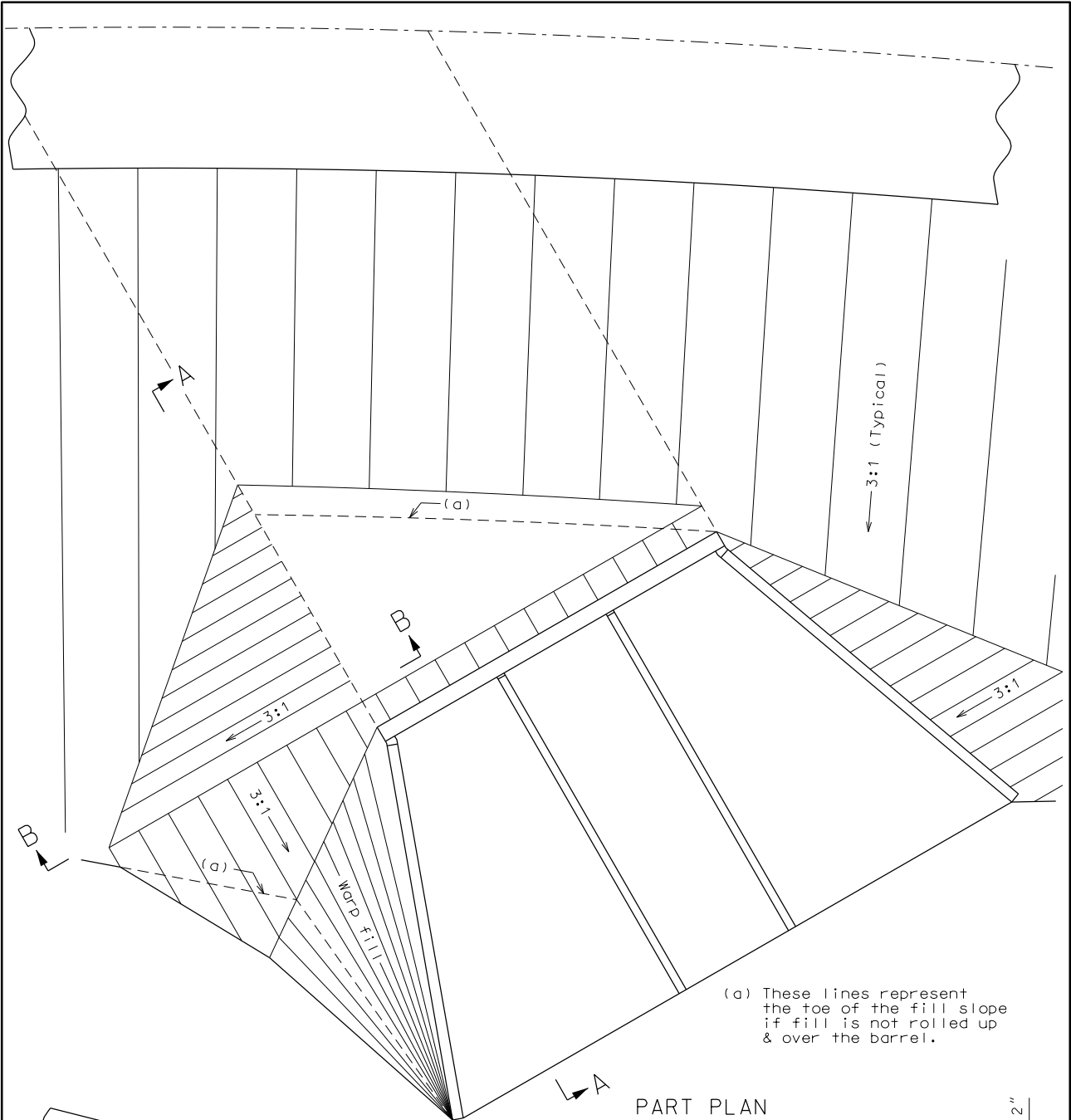

(a) These lines represent the toe of the fill slope if fill is not rolled up & over the barrel.

PART PLAN

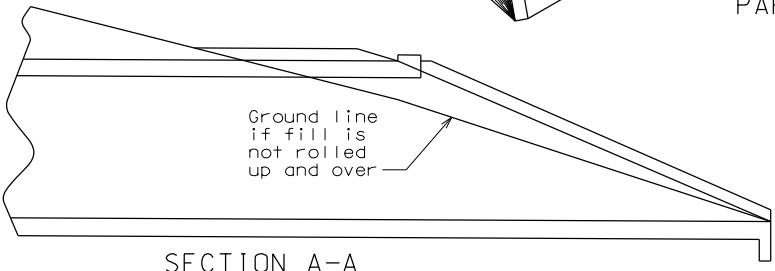

SECTION A-A

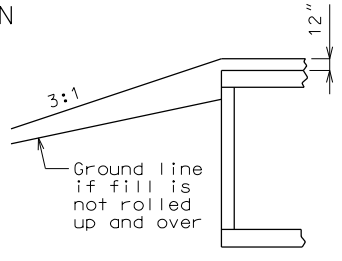

SECTION B-B

CASE 3  
FLARED INLET

ROADWAY FILL "ROLLED UP AND OVER" EXPOSED CULVERT

Not to be shown on plans - For illustration purposes only

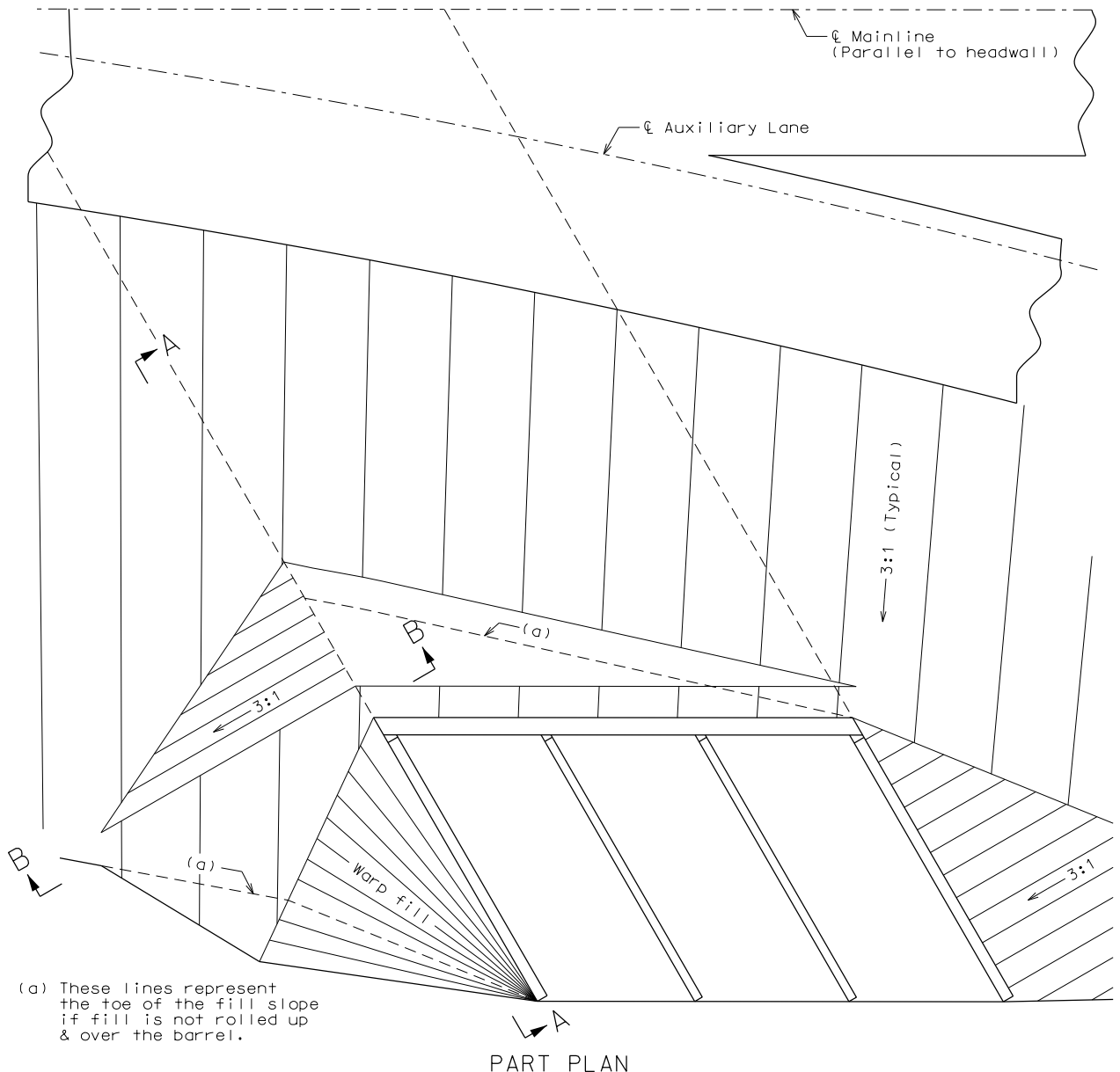

PART PLAN

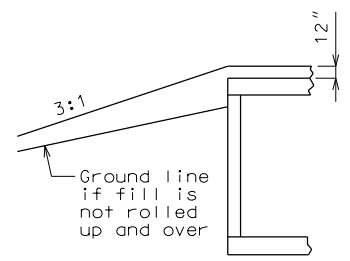
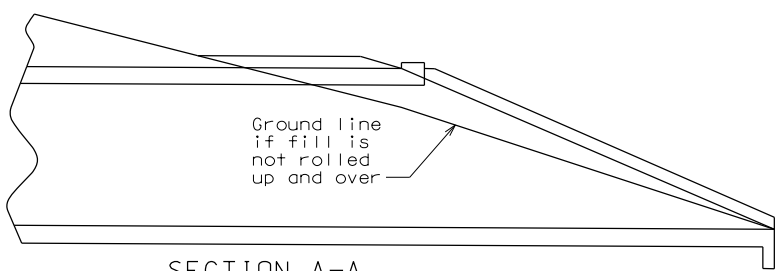

CASE 4

AUXILIARY LANE OR OUTER ROAD ALIGNMENT DIFFERENT THAN MAINLINE

ROADWAY FILL "ROLLED UP AND OVER" EXPOSED CULVERT

Not to be shown on plans - For illustration purposes only

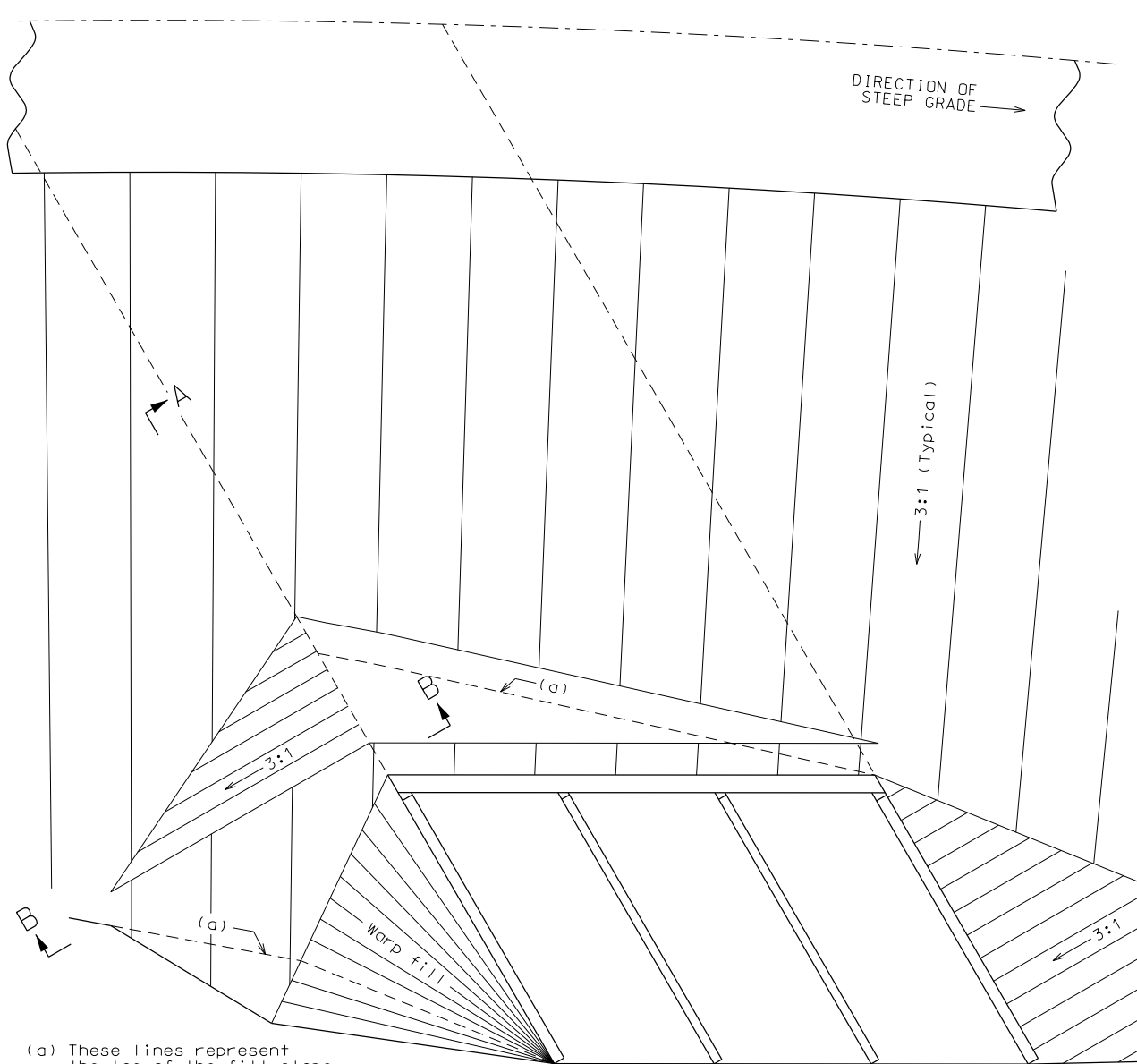

(a) These lines represent the toe of the fill slope if fill is not rolled up & over the barrel.

PART PLAN

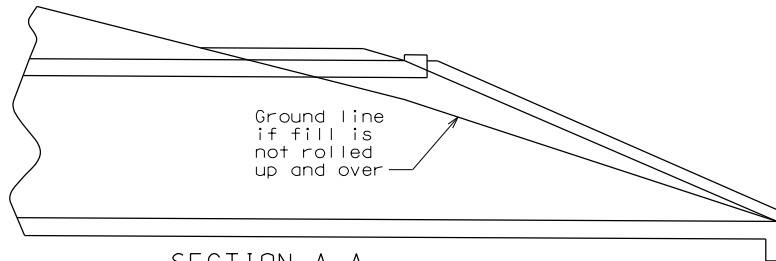

SECTION A-A

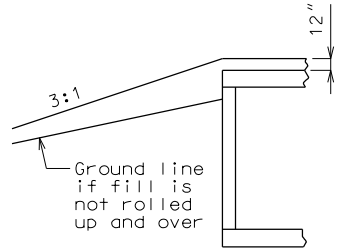

SECTION B-B

CASE 5

WIDE CULVERT AND A STEEP GRADE

ROADWAY FILL "ROLLED UP AND OVER" EXPOSED CULVERT

Not to be shown on plans - For illustration purposes only